



PNEUMAX

GREEN LINE
RACCORDERIA PNEUMATICA
PNEUMATIC FITTINGS
TECHNOLOGY & INNOVATION

silenzianti e filtri

silencer and filtering

tubi e terminali

tubes and terminals

valvole e funzioni di linea

line valves and functions

accessori per impianti e vari

plant accessories and more

strumentazione e dispositivi elettrici

instruments and electric devices



raccordi diritti in ottone nichelato

push-in brass straight fittings nickel-plated

raccordi in tecnopolimero con estremità in ottone nichelato

push-in technopolymer fittings with nickel-plated brass ends

raccordi intermedi e multipli

intermediate and multiple automatic connectors

regolatori di flusso

flow regulators





L'azienda

La Titan Engineering S.p.A. fondata nel 1993, è una società del Gruppo Pneumax, nata con l'obiettivo di diventare la sede produttiva e il magazzino centrale, per la raccorderia e gli accessori per l'aria compressa, di tutta la rete distributiva Pneumax, italiana e internazionale, attraverso un percorso sostenuto da iniziative strettamente legate alle strategie di sviluppo portate avanti dalla casa madre nel tempo. L'elemento che ha contribuito in modo determinante alla crescita dell'Azienda, nel corso di questi anni, è stato la capacità di sapersi modellare sulle esigenze e sulle indicazioni trasferite dalla Clientela, grazie alle quali sono stati fatti investimenti mirati in attività produttive interne, in accordi di collaborazione con i migliori partner italiani ed esteri, e si sono potenziati gli aspetti legati alla qualità e flessibilità del servizio offerto. L'obiettivo si è concretizzato con la realizzazione del "Catalogo Green Line", uno strumento per specialisti della raccorderia per aria compressa, fra i più completi proposti sul mercato.

Titan Engineering S.p.A.

47890 Zona Artigianale Ciarulla - RSM
Via dei Cerri, 16
Tel. 0549/961121
Fax 0549/960421
Cod. op. SM04813
www.titanengineering.sm

La vendita dei componenti illustrati e descritti nel presente catalogo viene effettuata in Italia e all'estero attraverso l'organizzazione indicata nella sez. "organizzazione commerciale". Dimensioni di ingombro e informazioni tecniche sono fornite a puro titolo informativo e possono essere modificate senza preavviso.

Pneumax S.p.A.

24050 LURANO (BG) Italy
Via Cascina Barbellina, 10
Tel. 035/4192777
www.pneumaxspa.com

CAPITALE SOCIALE EUR 2.700.000 I.V.
R.E.A. BERGAMO N. 160798
R.E.A. MILANO N. 931262
COD. FISC. E P. IVA 02893330163
COD. MECC. MI 322178



The company

Titan Engineering S.p.A. founded in 1993, is a company of the Pneumax Group, started with the goal of becoming the production site and warehouse, of fittings and accessories for compressed air, for the entire Pneumax distribution network (Italian and international), through a path supported by initiatives closely linked to the development strategies pursued by the mother Company over the past years.

The element that has contributed to the growth of the Company, during these years, was to be capable of modeling itself on the needs and directions transferred from the customers, through which have been made targeted investments in production activities, in cooperation agreements with the best Italian and foreign partners, and have enhanced the aspects related to the quality and flexibility of the service.

The goal has been reflected in the creation of the "Green Line Catalog", a tool for specialists of fittings for compressed air, among the most comprehensive available on the market.

Titan Engineering S.p.A.

47890 Zona Artigianale Ciarulla - RSM
Via dei Cerri, 16
Tel. 0549/961121
Fax 0549/960421
Cod. op. SM04813
www.titanengineering.sm

Sales of the components illustrated and described in the present catalogue in Italy and abroad are handled through the organization indicated in the section "sales network".

The overall dimensions and technical information are provided solely for informative reasons and may be subject to change without notice.

Pneumax S.p.A.

24050 LURANO (BG) Italy
Via Cascina Barbellina, 10
Tel. 035/4192777
www.pneumaxspa.com

CAPITALE SOCIALE EUR 2.700.000 I.V.
R.E.A. BERGAMO N. 160798
R.E.A. MILANO N. 931262
COD. FISC. E P. IVA 02893330163
COD. MECC. MI 322178



certificati • *certifications* 5



codifica raccordi • *push-in fittings coding* 8



raccordi automatici in ottone • *brass push-in fittings* "RAP" 9



raccordi automatici in tecnopolimero • *technopolymer push-in fittings* "TECNO-RAP" 35



food contact • *food contact* "FCM" 65



astine per raccordi automatici • *stems for push-in fittings* 77



regolatori di flusso • *flow regulators* 83



raccordi automatici in acciaio "SS" "RX" • *stainless steel push-in fittings* "SS" "RX" 101



raccordi automatici in ottone • *brass push-in fittings* "MINI" 117



raccordi standard "100-200-300" in ottone • *brass standard fittings "100-200-300"* 123

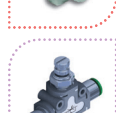

raccordi funzione • *function fittings* "TECNO-FUN" 147

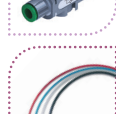

tubi e accessori • *tubes and accessories* 175

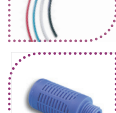

silenzianti, ugelli e ripartitori • *silencers, flow nozzle and manifolds* 184



valvole e rubinetti • *flow nozzles and ball taps* 199



Direttive RoHs - *Reach* 212

SQS Certificate

SQS herewith certifies that the company named below has a management system which meets the requirements of the standards specified below.

TITAN ENGINEERING
Titan Engineering S.p.A.
 Via dei Cerri, 16/46
 47899 Serravalle
 San Marino

Scope of certification
 Site of Via dei Cerri, 16
 47899 Serravalle/San Marino

Field of activity
Production and distribution of pneumatic components for the automation

Normative basis
ISO 9001:2015 Quality Management System
ISO 14001:2015 Environmental Management System

Scope(s) 29 Validity 02.11.2017 – 16.10.2020 Reg. no. 38506
 Issue 02.11.2017

V. Edelmann *R. Glauser*
 X. Edelmann, President SQS R. Glauser, CEO SQS

Swiss Association for Quality and Management Systems SQS
 Bernstrasse 103, 3052 Zollikofen, Switzerland

Partner of IQNet

SQS Certificate

SQS herewith certifies that the company named below has a management system which meets the requirements of the standard specified below.

TITAN ENGINEERING
Titan Engineering S.p.A.
 Via dei Cerri, 16
 47899 Serravalle
 San Marino

Scope of certification
 Site of Via dei Cerri, 16
 47899 Serravalle/San Marino

Field of activity
Production and distribution of pneumatic components for the automation

Normative base
ISO 45001:2018 Occupational Health and Safety Management System

Scope(s) 18, 29 Validity 15.01.2019 – 14.01.2022 Reg. no. 52144
 Issue 15.01.2019

V. Edelmann *F. Müller*
 X. Edelmann, President SQS F. Müller, CEO SQS

Swiss Association for Quality and Management Systems SQS
 Bernstrasse 103, 3052 Zollikofen, Switzerland

Partner of IQNet

IQNet
 THE INTERNATIONAL CERTIFICATION NETWORK
CERTIFICATE
 SQS has issued an IQNet recognized certificate that the organization:

Titan Engineering S.p.A.
 Via dei Cerri, 16
 47899 Serravalle
 San Marino

has implemented and maintains a
Management System
 for the following scope(s):
18, 29

which fulfills the requirements of the following standard(s):
ISO 45001:2018 Occupational Health and Safety Management System

Issued on: 2019-01-15
 Expires on: 2022-01-14

This attestation is directly linked to the IQNet Partner's original certificate and shall not be used as a stand-alone document

Registration Number: CH-52144

Alex Stoichitou *F. Müller*
 Alex Stoichitou, President of IQNet Felix Müller, CEO SQS

IQNet Partners**
 AENOR Spain, AFNOR Certification France, APCER Portugal, CCC Cyprus, CISQ Italy, CQC China, CQM China, CQS Czech Republic, Cro Cert Croatia, DQS Holding GmbH Germany, FCV Brazil, FONDORFORMA Venezuela, ICONTEC Colombia, Inspecta Certification Oy Finland, INTECO Costa Rica, IRAM Argentina, JQA Japan, KPO Korea, MIRTEC Greece, MSZT Hungary, Nemko AS Norway, NSAI Ireland, INICE-SIGS Mexico, PCBC Poland, Quality Austria Austria, RR Russia, SII Israel, SIO Slovenia, SIRIM QAS International Malaysia, SQS Switzerland, SRAC Romania, TEST St. Petersburg Russia, TSE Turkey, YUQO Serbia

IQNet is represented in the USA by: AFNOR Certification, CISO, IQS Holding GmbH and NSAI Inc.

* The list of IQNet partners is valid at the time of issue of this certificate. Updated information is available under www.iqnet-certification.com

IQNet
 THE INTERNATIONAL CERTIFICATION NETWORK
CERTIFICATE
 SQS and IQNet Partner hereby states that the organization:

Titan Engineering S.p.A.
 Via dei Cerri, 16/46
 47899 Serravalle
 San Marino

for the following scope and type of activities
 Site of Via dei Cerri, 16/46
 47899 Serravalle/San Marino

Production and distribution of pneumatic components for the automation

has implemented and maintains a
Management System
 which fulfills the requirements of the following standard(s)
ISO 9001:2015 / Quality Management System
ISO 14001:2015 / Environmental Management System

for the validity date, please refer to the original certificate* issued by SQS

Scope Note(s): 29
 Issued on: 2017-11-02
 Validity date: 2020-10-16
 Registration Number: CH-38586

Alex Stoichitou *R. Glauser*
 Alex Stoichitou, President of IQNet Roland Glauser, CEO SQS

IQNet Partners**
 AENOR Spain, AFNOR Certification France, APCER Portugal, CCC Cyprus, CISQ Italy, CQC China, SQM China, CQS Czech Republic, Cro Cert Croatia, DQS Holding GmbH Germany, FCV Brazil, FONDORFORMA Venezuela, ICONTEC Colombia, Inspecta Certification Oy Finland, INTECO Costa Rica, IRAM Argentina, JQA Japan, KPO Korea, MIRTEC Greece, MSZT Hungary, Nemko AS Norway, NSAI Ireland, PCBC Poland, Quality Austria Austria, RR Russia, SIGE Mexico, SII Israel, SIO Slovenia, SIRIM QAS International Malaysia, SQS Switzerland, SRAC Romania, TEST St. Petersburg Russia, TSE Turkey, YUQO Serbia

IQNet is represented in the USA by: AFNOR Certification, CISO, IQS Holding GmbH and NSAI Inc.

* This attestation is directly linked to the IQNet Partner's original certificate and shall not be used as a stand-alone document
 ** The list of IQNet partners is valid at the time of issue of this certificate. Updated information is available under www.iqnet-certification.com



Mission

Qualità non solo come fine, ma come stile comportamentale, animato da una intensa attività di sensibilizzazione e coinvolgimento; sulla base di questa premessa, i principali elementi con cui si è deciso di edificare il nostro Sistema Qualità sono: l'**AZIENDA**, la **PERSONA**, il **LAVORO**.

Valori autentici che, in un contesto generale mutevole ed imprevedibile, diventano punti di riferimento imprescindibili.

Ogni componente è parte attiva in un sistema fatto di reciprocità: dove l'azienda promuove il rispetto dei valori etici e dei diritti e della dignità delle persone, dove ogni persona è parte attiva e fattiva per il bene dell'azienda e dove il lavoro ne rappresenta il legante, ritornando ad essere un modello dinamico di crescita per se stessi e per il tessuto socio-economico.

Il raggiungimento della Certificazione ISO 45001:2018, 14001:2015 è una ulteriore garanzia verso i nostri Clienti e soprattutto il riconoscimento in qualcosa in cui crediamo.

*Quality not only as an end, but as a behavioral style, animated by an intense awareness and involvement, on the basis of this premise, the main elements with which it was decided to build our Quality System are: the **COMPANY**, the **PERSON**, the **JOB**.*

Authentic values which, in a general context changeable and unpredictable, they become points of reference indispensable.

Each component has an active part in a system made up of reciprocity: where the company promotes respect for ethical values and the rights and dignity of persons, where each person is an active and effective for the good of the company' and where the work represents the binder, returning to be a dynamic model of growth for themselves and for the socio-economic context.

Achieving ISO 45001:2018, 14001:2015 certification is an additional guarantee to our Customers, and above all the recognition in something we believe in.

Interpretazione della codifica dei raccordi automatici serie Rap e Tecnorap

Coding interpretation of Rap and Tecnorap push-in fittings series

Esempi reali di codifica dei raccordi automatici Rap e Tecnorap Real coding examples of Rap and Tecnorap push-in fittings				
A	B	C	D	
	22	04	18	Raccordo RAP, con anello spintore verde, ad L girevole, per tubo diam.4 mm, con filettatura da 1/8 <i>RAP fitting, with green thrust sleeve, elbow type, for tube size 4 mm, with 1/8 thread</i>
B	05	06	00	Raccordo RAP, con anello spintore nero, a T intermedio, per tubi diam.6 mm <i>RAP fitting, with black thrust sleeve, T connector, for tube size 6 mm</i>
	01OT	08	14	Raccordo RAP, con anello spintore metallico, diritto maschio, per tubo diam. 8 mm, con filettatura da 1/4 <i>RAP fitting, with metal thrust sleeve, straight male, for tube size 8 mm, with 1/4 thread</i>
T	03	10	00	Raccordo TECNORAP grigio, con anello spintore verde, diritto intermedio, per tubo diam.10 mm <i>TECNORAP grey fitting, with green thrust sleeve, straight connector, for tube size 10 mm</i>
TS	04	04	L0	Raccordo TECNORAP grigio, con anello spintore grigio, ad L intermedio, per tubo diam.4 mm, con codolo <i>TECNORAP grey fitting, with grey thrust sleeve, elbow connector, for tube size 4 mm, with plug</i>
TB	22T	06	18	Raccordo TECNORAP nero, con anello spintore nero, ad L girevole, con base in tecnopolimero, per tubo diam.6 mm, con filettatura da 1/8 <i>TECNORAP black fitting, with black thrust sleeve, elbow type, with technopolymer swivel, for tube size 6 mm, with 1/8 thread</i>
TBV	01	04	18	Raccordo TECNORAP nero, con anello spintore verde, diritto maschio, per tubo diam.4 mm, con filettatura da 1/8 <i>TECNORAP black fitting, with green thrust sleeve, straight male, for tube size 4 mm, with 1/8 thread</i>

Versione con corpo in tecnopolimero grigio TECNORAP Version with grey technopolymer body				
A	T	Anello spingitore di colore verde <i>Thrust sleeve color green</i>		
	TA	Anello spingitore di colore blu <i>Thrust sleeve color blue</i>		
	TN	Anello spingitore di colore nero <i>Thrust sleeve color black</i>		
	TS	Anello spingitore di colore grigio <i>Thrust sleeve color grey</i>		
B1	T01...T34	Tipo di articolo / <i>Type of item</i>		
B2	B	Versione due vie / <i>Branch version</i>		
	C	Filettatura conica / <i>Tapered thread</i>		
	F	Filettatura femmina cilindrica / <i>Parallel female thread</i>		
	FC	Filettatura femmina conica / <i>Tapered female thread</i>		
	G	Filettatura maschio cilindrica / <i>Parallel male thread</i>		
	L	Versione ad "elle prolungata" / <i>Version with longer elbow</i>		
	LC	Versione ad "elle prolungata" (conica) / <i>Version with longer elbow (tapered)</i>		
R	Versione per regolatore di flusso / <i>Version for speed controller</i>			
T	Versione con base girevole tecnopolimero / <i>Version with technopolymer swivel base</i>			
C	D.4...D.12	Diametro del tubo / <i>Tube diameter size</i>		
D1	18...12	Misura del filetto (1/8...1/2) / <i>Thread size (1/8...1/2)</i>		
D2	00	Stessa misura di D1 / <i>Same as D1</i>		
	D.4...D.14	Diametro del tubo / <i>Tube diameter size</i>		
	L0	Codolo centrale / <i>Version with plug</i>		
	V0	Codolo laterale / <i>Version with lateral plug</i>		

RAP - Versione con corpo in ottone nichelato RAP - Version with nickel-plated brass body		
A	blank	Anello spingitore di colore verde <i>Thrust sleeve color green</i>
	A	Anello spingitore di colore blu <i>Thrust sleeve color blue</i>
	B	Anello spingitore di colore nero <i>Thrust sleeve color black</i>
	S	Anello spingitore di colore grigio <i>Thrust sleeve color grey</i>
B1	01...60	Tipo di articolo / <i>Type of item</i>
B2	OT	Versione con anello spingitore in ottone nichelato <i>Version with nickel-plated thrust sleeve</i>
	C	Filettatura conica / <i>Apered thread</i>
	F	Filettatura femmina cilindrica/Corpo filettato <i>Parallel female thread/ threaded body</i>
	E	Maggiorazione / <i>Incraser</i>
	L	Versione ad "elle prolungata" <i>Version with longer elbow</i>
R	Versione per regolatore di flusso <i>Version for speed controller</i>	
C	D.4...D.14	Diametro del tubo / <i>Tube diameter size</i>
D1	18...12	Misura del filetto (1/8...1/2) / <i>Thread size (1/8...1/2)</i>
D2	00	Stessa misura di D1 / <i>Same as D1</i>
	D.4...D.14	Diametro del tubo / <i>Tube diameter size</i>
	V0	Versione con codolo laterale / <i>Version with lateral plug</i>

Versione con corpo in tecnopolimero nero TECNORAP Version with black technopolymer body		
A	TB	Anello spingitore di colore nero <i>Thrust sleeve color black</i>
	TBA	Anello spingitore di colore blu <i>Thrust sleeve color blue</i>
	TBS	Anello spingitore di colore grigio <i>Thrust sleeve color grey</i>
	TBV	Anello spingitore di colore verde <i>Thrust sleeve color green</i>
B1	TB01...TB34	Tipo di articolo / <i>Type of item</i>
B2	B	Versione due vie / <i>Branch version</i>
	C	Filettatura conica / <i>Tapered thread</i>
	F	Filettatura femmina cilindrica / <i>Parallel female thread</i>
	FC	Filettatura femmina conica / <i>Tapered female thread</i>
	G	Filettatura maschio cilindrica / <i>Parallel male thread</i>
	L	Versione ad "elle prolungata" <i>Version with longer elbow</i>
	LC	Versione ad "elle prolungata" conica <i>Version with longer elbow (tapered)</i>
	R	Versione per regolatore di flusso <i>Version for speed controller</i>
T	Versione con base girevole tecnopolimero <i>Version with technopolymer swivel base</i>	
C	D.4...D.12	Diametro del tubo / <i>Tube diameter size</i>
D1	18...12	Misura del filetto (1/8...1/2) / <i>Thread size (1/8...1/2)</i>
D2	00	Stessa misura di D1 / <i>Same as D1</i>
	D.4...D.14	Diametro del tubo / <i>Tube diameter size</i>
	L0	Codolo centrale / <i>Version with plug</i>
	V0	Codolo laterale / <i>Version with lateral plug</i>

Esempi di combinazioni e codifica - *Example of combination and coding*

<p>MAIN SERIES</p>  <p>100800</p>	<p>"B" SERIES</p>  <p>B100800</p>	<p>"OT" SERIES</p>  <p>100T0800</p>	<p>"S" SERIES</p>  <p>S100800</p>	<p>"A" SERIES</p>  <p>A100800</p>
<p>MAIN "T" SERIES</p>  <p>T100800</p>	<p>"TN" SERIES</p>  <p>TN100800</p>		<p>"TS" SERIES</p>  <p>TS100800</p>	<p>"TA" SERIES</p>  <p>TA100800</p>
<p>"TBV" SERIES</p>  <p>TBV100800</p>	<p>MAIN "TB" SERIES</p>  <p>TB100800</p>		<p>"TBS" SERIES</p>  <p>TBS100800</p>	<p>"TBA" SERIES</p>  <p>TBA100800</p>

NOTA: la presente tabella è la rappresentazione reale, basata sull'articolo "passaparte per tubi diametro 8mm", delle diverse combinazioni e codifiche descritte a pag. 7.

NOTE: the present table is the real representation, based on the item "bulkhead for 8mm diameter pipes", of the different combinations and coding described at page 7.



RAP

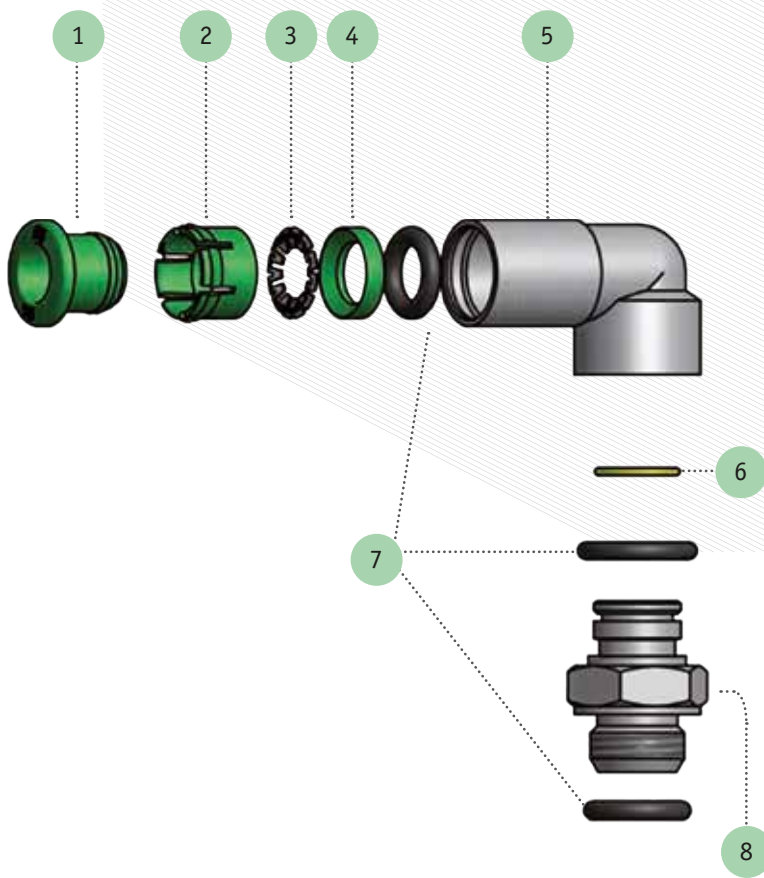

- 1 ANELLO SPINGITORE
THRUST SLEEVE
- 2 DISTANZIALE DI FERMO
LOCK RING
- 3 PINZA DI AGGRAFFAGGIO
CRIMPING GRIPPER
- 4 ANELLO DI SOSTEGNO
SUPPORTING RING
- 5 CORPO RACCORDO
FITTING BODY
- 6 ANELLO ELASTICO
ELASTIC RING
- 7 O-RING DI TENUTA
O-RING SEAL
- 8 BASE GIREVOLE
SWIWEL BASE



ART. 01

Diritto filetto cilindrico maschio con O-ring
Straight male adaptor (parallel)

CODICE	ØD	G	ØC	ØB	H	L			
01CH04M5*	4	M5	2,2	11,3	3,5	20	10	2	100
0104M5	4	M5	2,6	9	4	20,5	Ø9	2,5	100
0104M6	4	M6	2,6	9	5	20,5	Ø9	2,5	50
010418	4	1/8	2,6	13,5	5,5	20	9	2,5	50
010414	4	1/4	2,6	17	6,5	21	9	2,5	50
0106M5	6	M5	2,6	11	4	22,8	Ø11	2,5	50
0106M6	6	M6	2,6	11	5	24,8	Ø11	2,5	50
010618	6	1/8	4,2	13,5	5,5	25,3	11	4	50
010614	6	1/4	4,2	17	6,5	24,3	11	4	50
010818	8	1/8	5,2	12,8	5,5	27	13	5	50
010814	8	1/4	6,2	17	6,5	25,5	13	6	50
010838	8	3/8	6,2	20	7,5	25,5	13	6	50
010812	8	1/2	6,2	24	10	25	14	6	25
011018*	10	1/8	5,9	9	5,5	29	17	4	25
011014	10	1/4	7,3	16	6,5	30,4	16	7	50
011038	10	3/8	8,3	21	7,5	30,9	16	8	50
011012	10	1/2	14,1	23	10	24,7	17	8	25
011214	12	1/4	7,3	16	6,5	33,2	19	7	25
011238	12	3/8	10,3	22	7,5	33,2	19	10	25
011212	12	1/2	10,3	24	9	33,2	19	10	25
011438	14	3/8	10,3	21	7,5	35	19	10	25
011412	14	1/2	12,3	25	9	35	19	12	25

* = di importazione - imported

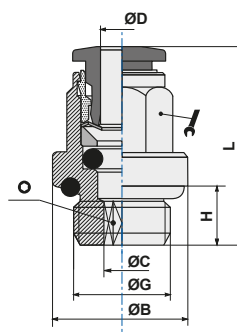

ART. 01C

Diritto filetto conico maschio
Straight male adaptor (tapered)

CODICE	ØD	G		H	L			
01C0418	4	1/8		7,5	18	10	2,5	50
01C0414	4	1/4		9,5	16	14	2,5	50
01C0438	4	3/8		7,5	17,4	17	3	25
01C0618	6	1/8		7,5	19,5	12	4	50
01C0614	6	1/4		9,5	22,3	14	4	50
01C0638	6	3/8		10,5	20,3	17	4	25
01C0612	6	1/2		10	23,2	24	4	25
01C0818	8	1/8		7,5	25,5	14	5	50
01C0814	8	1/4		9,5	24,5	14	6	50
01C0838	8	3/8		10,5	21,5	17	6	50
01C0812	8	1/2		12,5	25,5	21	6	25
01C1018	10	1/8		7,5	29,5	17	4	25
01C1014	10	1/4		9,5	30,8	17	7	50
01C1038	10	3/8		10,5	28,3	17	8	50
01C1012	10	1/2		13,5	26,6	21	8	25
01C1218	12	1/8		7	31	21	4	25
01C1214	12	1/4		9,5	33	19	6	25
01C1238	12	3/8		10,5	30	21	10	25
01C1212	12	1/2		13,5	32,5	21	10	25
01C1438	14	3/8		9	37,5	21	10	25
01C1412	14	1/2		14	35	21	10	25

NOTA: articolo di importazione - NOTE: imported item

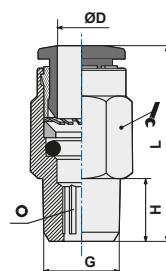

ART. 02

 Diritto femmina
Straight female adaptor

CODICE	ØD	G	ØC	ØB	H	L		
020418	4	1/8	3	12	6,5	26,5	9	50
020414	4	1/4	3	17	10	29,5	9	50
020618	6	1/8	5	12	6,5	28,3	11	50
020614	6	1/4	5	17	10	31,3	11	50
020818	8	1/8	7	12	6,5	28,5	13	50
020814	8	1/4	7	17	10	32,5	13	50

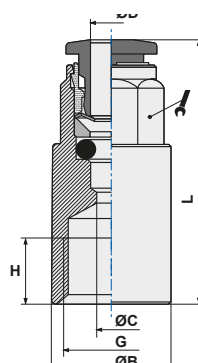
ART. 03

 Diritto innestabile
Straight connector

CODICE	ØD	ØD1	ØB	ØC	L		
030400	4	4	3	9	32		50
030600	6	6	5	11	36,1		50
030800	8	8	7	13	38		50
031000	10	10	9	16	42,3		50
031200	12	12	11	19	45,8		25
031400	14	14	13	21	48,9		25

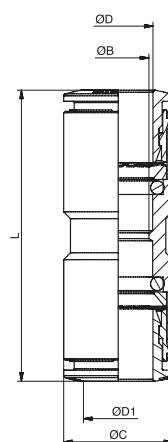
ART. 03F

 Diritto innestabile filettato
Threaded connector

CODICE	ØD	ØC	M	L		
03F0400	4	3	11x1	32		50
03F0600	6	5	14x1	36,1		50
03F0800	8	7	16x1	38		50
03F1000	10	9	18x1	42,3		50
03F1200	12	11	22x1	45,8		25
03F1400	14	13	24x1	47,5		25

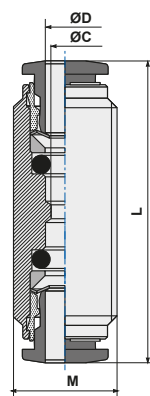
ART. 04

 Gomito innestabile
L connector

CODICE	ØD	ØC	ØB	L		
040400	4	3	10	19		50
040600	6	5	11	20,6		50
040800	8	7	13	23		50
041000	10	8	16	26,4		50
041200	12	10	19	28,9		25
041400	14	12	21	31,5		25

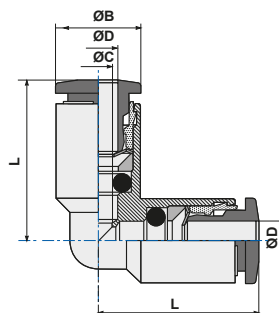

ART. 04L0

Gomito innestabile con codolo
Plug-in L connector

CODICE	ØD1	ØD2	L1	L2	L3	
0404L0	4	4	34,5	18	16,7	50
0406L0	6	6	42,5	23	19,5	50
0408L0	8	8	46,5	25,5	21	50
0410L0	10	10	51	27	24	25
0412L0	12	12	54	29	25	25

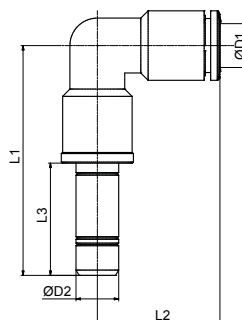

ART. 05

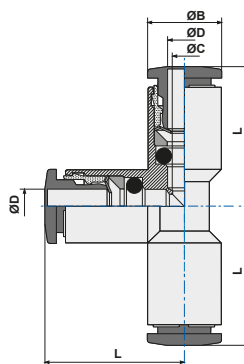

T innestabile
T connector

CODICE	ØD	ØC	ØB	L	
050400	4	3	9	17,3	50
050600	6	5	11	20,6	50
050800	8	7	13	23	50
051000	10	8	16	26,4	25
051200	12	10	19	28,9	25
051400	14	12	21	31,5	10



ART. 06

Innesto filetto cilindrico con O-Ring
Adaptor parallel (short)

CODICE	ØB	F	ØA	ØC	ØD	H	L		
0604M5	4	M5	8	2	2	4	24,7	8	50
0604M6	4	M6	9	2	2	5	25,7	8	50
060418	4	1/8	13	5,5	2	5,5	27,7	13	50
060414	4	1/4	16	7,5	2	6,5	29,2	13	50
0606M5	6	M5	8	2,6	2,6	4	27,5	8	50
060618	6	1/8	13	5,5	4	5,5	30,5	13	50
060614	6	1/4	16	7,5	4	6,5	32,0	13	50
060818	8	1/8	13	6	6	5,5	32,0	13	50
060814	8	1/4	16	7,5	6	6,5	33,5	13	50
060838	8	3/8	20	9	6	7,5	35,5	13	50
061018	10	1/8	13	6	6	5,5	35,0	13	50
061014	10	1/4	16	8	8	6,5	36,5	13	50
061038	10	3/8	20	8	8	7,5	39,5	13	50
061214	12	1/4	16	8	8	6,5	37,5	13	25
061238	12	3/8	20	11	10	7,5	40,5	13	25
061212	12	1/2	24	13	10	9	42,0	16	25
061438	14	3/8	20	12	12	7,5	43,0	16	25
061412	14	1/2	24	13	12	9	44,5	16	25

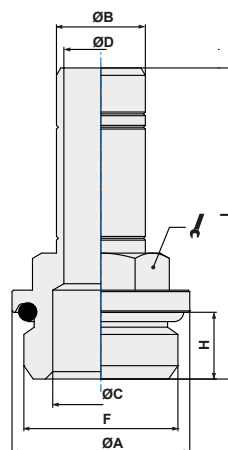

ART. 60

 Innesto proungato filetto cilindrico con O-Ring
Adaptor parallel long

CODICE	ØD	G	ØC	ØB	H	L	ØA		
600418	4	1/8	2	13	5	39	6	13	50
600618	6	1/8	4	13	5	44,5	5,5	13	50
600614	6	1/4	4	16	6,5	48	7,5	13	50
600818	8	1/8	6	13	5	48	6	13	50
600814	8	1/4	6	16	6,5	49,5	7,5	13	50
600838	8	3/8	6	20	7,5	51,5	9	13	50
601038	10	3/8	8	13	7,5	57,5	9	13	25

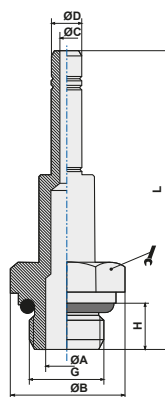
ART. 07

 Prolungamento
Connector

CODICE	ØD	ØC	L	
070400	4	2	33,4	100
070600	6	4	39	50
070800	8	6	42	50
071000	10	8	48	50
071200	12	10	50	50

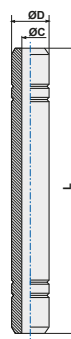
ART. 08

 Riduzione con codolo
Plug-in reducer

CODICE	ØD1	ØD2	ØB	L	
080604	6	4	9	32,5	50
080804	8	4	9	34	50
080806	8	6	11	36	50
081006	10	6	11	39,3	50
081008	10	8	13	39	50
081208	12	8	13	39,5	25
081210	12	10	16	41,4	25
081406	14	6	15	43,8	25

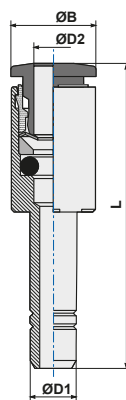
ART. 08E

 Maggiorazione con codolo
Plug-in increaser

CODICE	ØD1	ØD2	ØB	L	
08E0406	4	6	11	35,5	50
08E0608	6	8	13	39	50

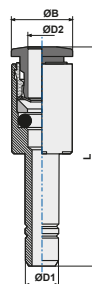

ART. 09 Tappo
Plug

CODICE	ØD	ØB			L	
090400	4	5			26	50
090600	6	7			29	50
090800	8	9			31,5	50
091000	10	11			35	50
091200	12	13			37	25

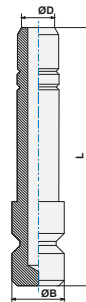

ART. 10 Passaparete
Bulkhead connector

CODICE	ØD	ØC	M	Imax	L		
100400	4	3	11x1	8	32	14	50
100600	6	5	14x1	8	36,1	17	50
100800	8	7	16x1	10	38	18	50
101000	10	9	18x1	12	42,3	21	25
101200	12	11	22x1	17	45,8	26	25
101400	14	13	24x1	18	47,5	27	25

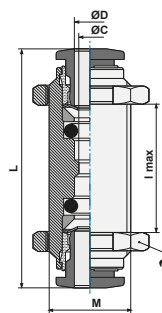

ART. 10L Passaparete ad L
L bulkhead

CODICE	ØD	M	H	L1	L2			
10L0400	4	M11x1	12,5	25,5	20	13	13	50
10L0600	6	M14x1	15	28	21	17	17	50
10L0800	8	M16x1	17	30,5	24	18	18	50
10L1000	10	M18x1	19	35	27	21	21	25

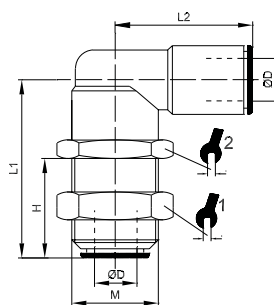

ART. 13 Anello semplice
Single banjo body

CODICE	ØD	G*	ØA	ØB	H	L	
1304M5	4	M5	5	8	9	19,5	50
130418	4	1/8	9,9	14	15	21,1	50
130618	6	1/8	9,9	14	15	24,3	50
130614	6	1/4	13,3	18	17	25,5	50
130818	8	1/8	9,9	14	15	24,8	50
130814	8	1/4	13,3	18	17	26,5	50
130838	8	3/8	16,75	21	20	28,0	50
131014	10	1/4	13,3	18	17	28,4	50
131038	10	3/8	16,75	21	20	29,9	25
131214	12	1/4	13,3	18	17	30,9	25
131238	12	3/8	16,75	21	20	31,4	25
131212	12	1/2	21	26	24	34,9	25
13R04M5	4	M5	6	8	9	19,5	50
13R06M5	6	M5	6	8	9	22,5	50

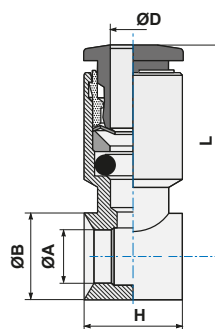

(*) G = filetto vite/asta
(*) G = steam thread

Vedi capitolo Astine pag. 39
See page 39 of Stems section

ART. 14
Anello doppio
Double banjo body

CODICE	ØD	G*	ØA	ØB	H	L		
140618	6	1/8	9,9	14	15	24,3		50
140818	8	1/8	9,9	14	15	24,8		50
140814	8	1/4	13,3	18	17	26,5		50
140838	8	3/8	16,75	21	20	28		50
141014	10	1/4	13,3	18	17	28,4		50
141038	10	3/8	16,75	21	20	29,9		25

 (*) G = filetto vite/asta
 (*) G = steam thread

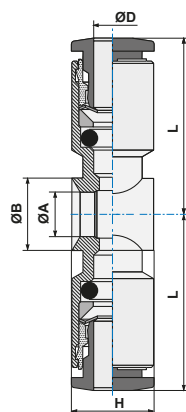
 Art. disponibile fino ad esaurimento scorte
 Item available while stocks last

ART. 15
Anello semplice girevole con asta
Complete single banjo (rotating under pressure)

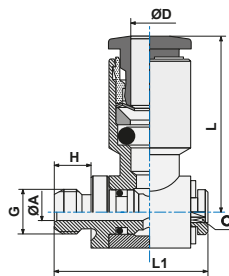
CODICE	ØD	G	ØA	H	L1	L		
1504M5	4	M5	2	4	16,8	19,5	2,5	50
1504M6	4	M6	2	4	17,8	19,5	2,5	50
150418	4	1/8	5,5	5,5	25	21,1	3	50
1506M5	6	M5	2	4	16,5	22	2,5	50
150618	6	1/8	5,5	5,5	24,5	24,3	3	50
150614	6	1/4	7,8	6,5	28	25,5	4	50
150818	8	1/8	5,5	5,5	24,5	24,8	3	50
150814	8	1/4	7,8	6,5	28	26,5	4	50
150838	8	3/8	10	7,5	32,5	28	5	25
151014	10	1/4	7,8	6,5	28	28,4	4	25
151038	10	3/8	10	7,5	32,5	29,9	5	25
151214	12	1/4	7,8	6,5	28	30,9	4	25
151238	12	3/8	10	7,5	32,5	31,4	5	25
151212	12	1/2	12	9	40,8	34,9	8	10

ART. 16
Anello doppio girevole con asta
Complete double banjo (rotating under pressure)

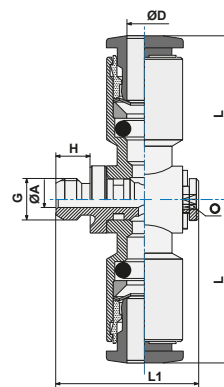
CODICE	ØD	G	ØA	H	L1	L		
160618	6	1/8	5,5	5,5	24,5	24,3	3	50
160818	8	1/8	5,5	5,5	25	24,8	3	50
160814	8	1/4	7,8	6,5	28	26,5	4	25
160838	8	3/8	10	7,5	32,5	28	5	25
161014	10	1/4	7,8	6,5	28	28,4	4	25
161038	10	3/8	10	7,5	32,5	29,9	5	25

 Art. disponibile fino ad esaurimento scorte
 Item available while stocks last

ART. 19

Raccordo ad elle fisso conico maschio
L tapered male adapter

CODICE	ØD	G	ØB	E	L		
190418	4	1/8	9	18,6	16,5	10	100
190618	6	1/8	11	23,8	16,5	10	100
190614	6	1/4	11	25,3	22,5	11	100
190818	8	1/8	13	25,5	18,5	11	100
190814	8	1/4	13	25,5	22,0	11	100
191014	10	1/4	16	28,0	24,0	13	50

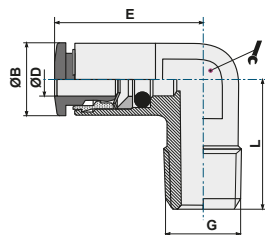

ART. 20

Raccordo a T centrale girevole
Swivel male stud T parallel

CODICE	ØD	A	H	ØB	L1	L2		
2004M5	4	M5	4	9	17,3	20,0	8	50
200418	4	1/8	5,5	11,40	17,3	18,5	13	50
200414	4	1/4	6,5	9	19,0	22,5	16	50
2006M5	6	M5	4	11,20	20,5	21	8	50
200618	6	1/8	5,5	11	19,5	18,5	13	50
200614	6	1/4	6,5	11	22,1	22,5	16	50
200818	8	1/8	5,5	13	23,0	20,5	13	50
200814	8	1/4	6,5	13	23,0	22,5	16	50
200838	8	3/8	7,5	13	24,5	25,5	18	25
201014	10	1/4	6,5	16	26,4	24,5	16	25
201038	10	3/8	7,5	16	26,4	25,5	18	25

NOTA: articolo di importazione - NOTE: imported item

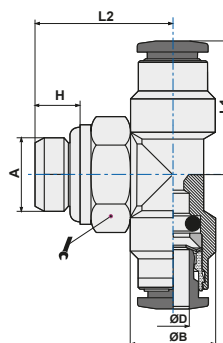

ART. 21

Raccordo a T laterale girevole
Swivel male branch T parallel

CODICE	ØD	G	H	ØB	L1	L2		
2104M5*	4	M5	4	8	16,5	19	9	50
210418	4	G1/8	5,5	13	18,5	17,5	13	50
210414	4	G1/4	6,5	16	22,5	19	13	50
210618	6	G1/8	5,5	13	20	21	13	50
210614	6	G1/4	6,5	16	24	21	13	50
210818	8	G1/8	5,5	13	20	23	13	50
210814	8	G1/4	6,5	16	24	23	13	50
210838	8	G3/8	4,5	20	25,5	23	13	25
211014*	10	G1/4	6,5	16	24	27	16	25

* = Art. di importazione
* = Imported item

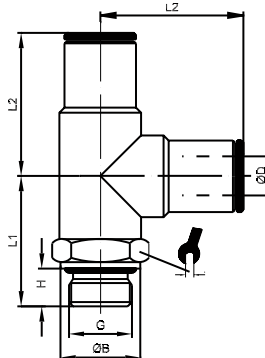

ART. 22

 Gomito girevole filetto cilindrico maschio con O-Ring
Swivel L male adaptor parallel

CODICE	ØD	A	H	ØB	L1	L2		
2204M5	4	M5	4	9,1	17,3	14,8	9	100
2204M12	4	M12x1,5	8	9,1	18,0	20,0	13	100
220418	4	1/8	5,5	9,1	18,0	20,0	13	100
220414	4	1/4	6,5	9,1	18,0	24,0	13	100
220438	4	3/8	7,5	9,1	18,0	25,5	13	100
2206M5	6	M5	4	11	14,5	21,0	9	100
2206M12	6	M12x1,5	8	11	23,0	25,5	13	100
220618	6	1/8	5,5	11	23,0	20,0	13	100
220614	6	1/4	6,5	11	23,0	24,0	13	100
220638	6	3/8	7,5	11	23,0	25,5	13	100
2208M12	8	M12x1,5	8	13	25,5	25,5	13	100
220818	8	1/8	5,5	13	25,5	20,3	13	100
220814	8	1/4	6,5	13	25,5	24,3	13	100
220838	8	3/8	7,5	13	25,5	25,8	13	50
221014	10	1/4	6,5	16	27,0	26,0	16	50
221038	10	3/8	7,5	16	27,0	27,5	16	50
221012	10	1/2	9	16	27,0	27,5	16	50
221214	12	1/4	6,5	19	29,0	30,5	16	25
221238	12	3/8	7,5	19	29,0	28,5	20	25
221212	12	1/2	9	19	29,0	33,5	20	25
221438	14	3/8	7,5	21	32,0	28,5	20	25
221412	14	1/2	9	21	32,0	33,5	20	25

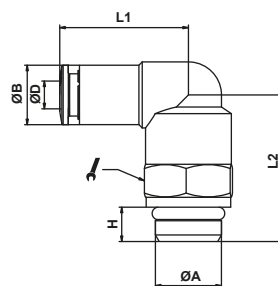
ART. 22L

 Gomito girevole cilindrico lungo
Swivel longer L male adaptor parallel

CODICE	ØD	G	ØB	H	L1	L2		
22L04M5	4	M5	8	4	23,5	18	9	25
22L0418	4	G1/8	13	6	33	20	13	25
22L0414	4	G1/4	16	8	38	20	13	25
22L06M5	6	M5	8	4	23,5	21	9	25
22L0618	6	G1/8	13	6	33	21	13	25
22L0614	6	G1/4	16	8	38	21	13	25
22L0818	8	G1/8	13	6	33	24	13	25
22L0814	8	G1/4	16	8	38	24	13	25
22L1014	10	G1/4	16	8	37	26,5	16	25

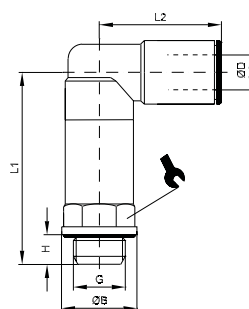
ART. 22L0

 Gomito innestabile con codolo
Plug-in L connector

CODICE	ØD1	ØD2	L1	L2	L3	
2204L0	4	4	19,5	18	15,5	50
2206L0	6	6	26,5	20	18	50
2208L0	8	8	31	24	19,5	50
2210L0	10	10	41	25	24	25
2212L0	12	12	29	28	25	25

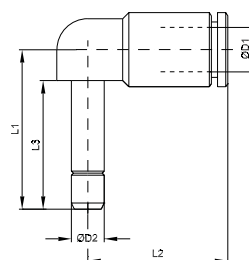

ART. 25 Passaparete femmina
Female bulkhead

CODICE	ØA	C	ØB	D	E	L		
250418	4	1/8	M12x1	15,5	8,5	24,0	14	25
250618	6	1/8	M14x1	15,8	8,5	26,8	15	25
250614	6	1/4	M14x1	15,8	11,0	29,5	17	25
250818	8	1/8	M16x1	16,0	8,5	26,5	19	25
250814	8	1/4	M16x1	16,0	11,0	32,0	19	25

NOTA: articolo di importazione - NOTE: imported item

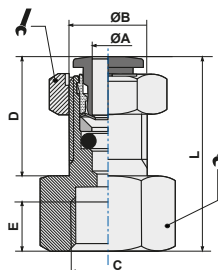

ART. 27 Cartuccia
Cartridge

CODICE	ØD	ØC	H	ØS	L	
270400	4	2,9	14	9,1	13,5	100
270600	6	5	16	11,1	15,5	50
270800	8	7	17	13,6	16,5	50

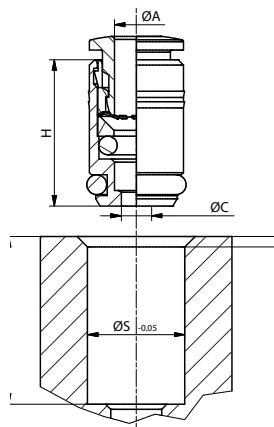

ART. 33 Doppio anello semplice girevole con asta
Swivel double banjo stem

CODICE	ØD	G	ØA	H	L1	L			
330418	4	1/8	5,5	5,5	43,8	21,1	14	3	25
330618	6	1/8	5,5	5,5	43,8	24,3	14	3	25
330614	6	1/4	7,8	7,5	51,5	25,5	18	4	25
330818	8	1/8	5,5	5,5	43,8	24,8	14	3	25
330814	8	1/4	7,8	7,5	51,5	26,5	18	4	25
331014	10	1/4	7,8	7,5	51,5	28,4	18	4	25

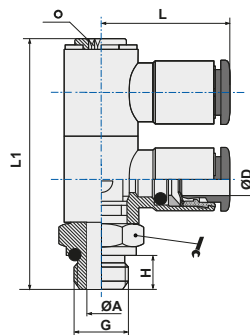

ART. 34 Triplo anello semplice girevole con asta
Swivel triple banjo stem

CODICE	ØD	G	ØA	H	L1	L			
340418	4	1/8	5,5	5,5	58,4	21,1	14	3	10
340618	6	1/8	5,5	5,5	58,4	24,3	14	3	10
340614	6	1/4	7,8	7,5	67	25,5	18	4	10
340818	8	1/8	5,5	5,5	58,4	24,8	14	3	10
340814	8	1/4	7,8	7,5	67	26,5	18	4	10
341014	10	1/4	7,8	7,5	67	51,5	18	4	10

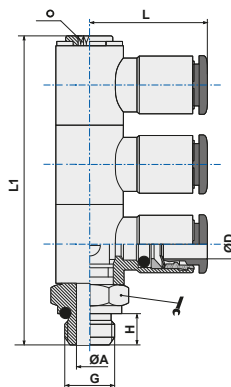

ART. 01AM

Diritto filetto cil. m. con O-Ring spintore maggiorato
Straight male adaptor (parallel) larger pusher

CODICE	ØD	ØD1	G	ØC	ØB	H	L			
010814AM	8	25	1/4	6,2	17	6,5	26	13	6	

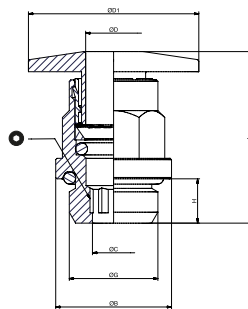

ART. 03AM

Diritto innestabile spintore maggiorato
Straight connector larger pusher

CODICE	ØD	ØD1	G	ØC	ØB	H	L			
030800AM	8	15			7		39			

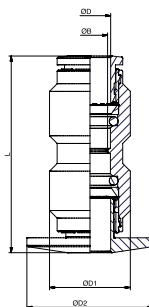

ART. 04AM

Gomito innestabile spintore maggiorato
L connector larger pusher

CODICE	ØD	ØD1	G	ØC	ØB	L1	L			
040800AM	8	25		7	13	24	23			

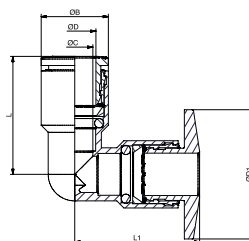

ART. 15AM

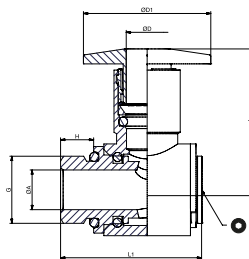

Anello semplice girevole con asta spintore maggiorato
Complete single banjo (rotating under pressure) larger pusher

CODICE	ØD	ØD1	G	ØA	H	L	L1			
T150814AM	8	25	1/4	7,8	6,5	29	26,5		4	



ART. B01

Diritto filetto cilindrico maschio con O-Ring
Straight male adaptor (parallel)

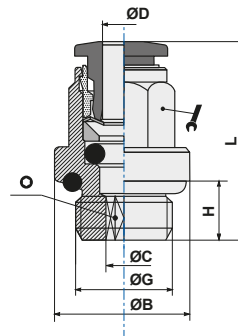

CODICE	ØD	G	ØC	ØB	H	L			
B0104M5	4	M5	2,6	9	4	20,5	Ø9	2,5	100
B0104M6	4	M6	2,6	9	5	20,5	Ø9	2,5	50
B010418	4	1/8	2,6	13,5	5,5	20	9	2,5	50
B010414	4	1/4	2,6	17	6,5	21	9	2,5	50
B0106M5	6	M5	2,6	11	4	22,8	Ø11	2,5	50
B0106M6	6	M6	2,6	11	5	24,8	Ø11	2,5	50
B010618	6	1/8	4,2	13,5	5,5	25,3	11	4	50
B010614	6	1/4	4,2	17	6,5	24,3	11	4	50
B010818	8	1/8	5,2	12,8	5,5	27	13	5	50
B010814	8	1/4	6,2	17	6,5	25,5	13	6	50
B010838	8	3/8	6,2	20	7,5	25,5	13	6	50
B010812	8	1/2	6,2	24	10	25	14	6	25
B011018*	10	1/8	5,9	9	5,5	29	17	4	25
B011014	10	1/4	7,3	16	6,5	30,4	16	7	50
B011038	10	3/8	8,3	21	7,5	30,9	16	8	50
B011012	10	1/2	14,1	23	10	24,7	17	8	25
B011214	12	1/4	7,3	16	6,5	33,2	19	7	25
B011238	12	3/8	10,3	22	7,5	33,2	19	10	25
B011212	12	1/2	10,3	24	9	33,2	19	10	25
B011438	14	3/8	10,3	21	7,5	35	19	10	25
B011412	14	1/2	12,3	25	9	35	19	12	25

* = di importazione - imported



ART. B01C

Diritto filetto conico maschio
Straight male adaptor (tapered)

CODICE	ØD	G		H	L			
B01C0418	4	1/8		7,5	18	10	2,5	50
B01C0414	4	1/4		9,5	16	14	2,5	50
B01C0438	4	3/8		7,5	17,4	17	3	25
B01C0618	6	1/8		7,5	19,5	12	4	50
B01C0614	6	1/4		9,5	22,3	14	4	50
B01C0638	6	3/8		10,5	20,3	17	4	25
B01C0612	6	1/2		10	23,2	24	4	25
B01C0818	8	1/8		7,5	25,5	14	5	50
B01C0814	8	1/4		9,5	24,5	14	6	50
B01C0838	8	3/8		10,5	21,5	17	6	50
B01C0812	8	1/2		12,5	25,5	21	6	25
B01C1018	10	1/8		7,5	29,5	17	4	25
B01C1014	10	1/4		9,5	30,8	17	7	50
B01C1038	10	3/8		10,5	28,3	17	8	50
B01C1012	10	1/2		13,5	26,6	21	8	25
B01C1218	12	1/8		7	31	21	4	25
B01C1214	12	1/4		9,5	33	19	6	25
B01C1238	12	3/8		10,5	30	21	10	25
B01C1212	12	1/2		13,5	32,5	21	10	25
B01C1438	14	3/8		9	37,5	21	10	25
B01C1412	14	1/2		14	35	21	10	25

NOTA: articolo di importazione - NOTE: imported item

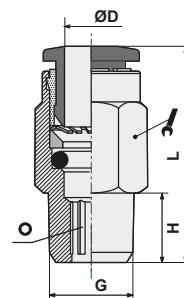

ART. B02

 Diritto femmina
Straight female adaptor

CODICE	ØD	G	ØC	ØB	H	L		
B020418	4	1/8	3	12	6,5	26,5	9	50
B020414	4	1/4	3	17	10	29,5	9	50
B020618	6	1/8	5	12	6,5	28,3	11	50
B020614	6	1/4	5	17	10	31,3	11	50
B020818	8	1/8	7	12	6,5	28,5	13	50
B020814	8	1/4	7	17	10	32,5	13	50

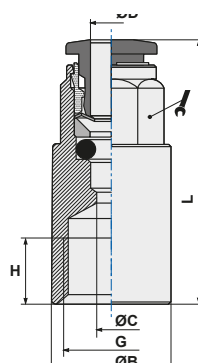
ART. B03

 Diritto innestabile
Straight connector

CODICE	ØD	ØD1	ØB	ØC	L		
B030400	4	4	3	11	32		50
B030600	6	6	5	13	36,1		50
B030800	8	8	7	15	38		50
B031000	10	10	9	18	42,3		50
B031200	12	12	11	21	45,8		25
B031400	14	14	13	23	48,9		25

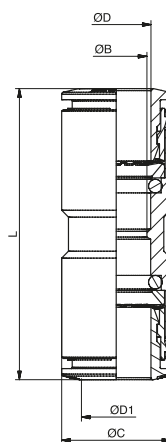
ART. B03F

 Diritto innestabile filettato
Threaded connector

CODICE	ØD	ØC	M	L		
B03F0400	4	3	11x1	32		50
B03F0600	6	5	14x1	36,1		50
B03F0800	8	7	16x1	38		50
B03F1000	10	9	18x1	42,3		50
B03F1200	12	11	22x1	45,8		25
B03F1400	14	13	24x1	47,5		25

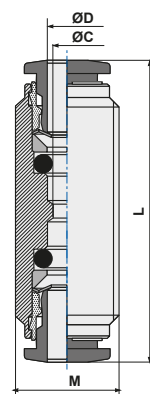
ART. B04

 Gomito innestabile
L connector

CODICE	ØD	ØC	ØB	L		
B040400	4	3	10	19		50
B040600	6	5	11	20,6		50
B040800	8	7	13	23		50
B041000	10	8	16	26,4		50
B041200	12	10	19	28,9		25
B041400	14	12	21	31,5		25

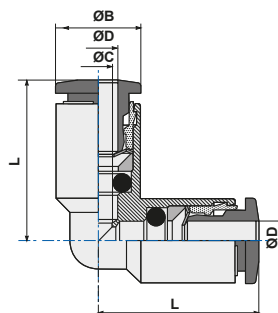

ART. B04L0 Gomito innestabile con codolo
Plug-in L connector

CODICE	ØD1	ØD2	L1	L2	L3	
B0404L0	4	4	34,5	18	16,7	50
B0406L0	6	6	42,5	23	19,5	50
B0408L0	8	8	46,5	25,5	21	50
B0410L0	10	10	51	27	24	25
B0412L0	12	12	54	29	25	25

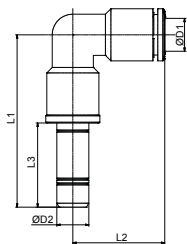

ART. B05 T innestabile
T connector

CODICE	ØD	ØC	ØB	L	
B050400	4	3	9	17,3	50
B050600	6	5	11	20,6	50
B050800	8	7	13	23	50
B051000	10	8	16	26,4	25
B051200	12	10	19	28,9	25
B051400	14	12	21	31,5	10

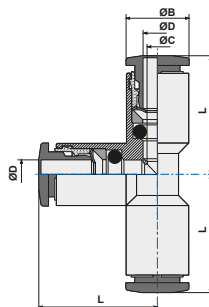

ART. B08 Riduzione con codolo
Plug-in reducer

CODICE	ØD1	ØD2	ØB	L	
B080604	6	4	9	32,5	50
B080804	8	4	9	34	50
B080806	8	6	11	36	50
B081006	10	6	11	39,3	50
B081008	10	8	13	39	50
B081208	12	8	13	39,5	25
B081210	12	10	16	41,4	25
B081406	14	6	15	43,8	25

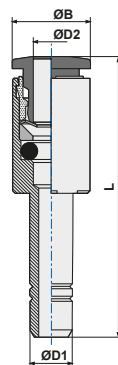

ART. B08/E Maggiorazione con codolo
Plug-in increaser

CODICE	ØD1	ØD2	ØB	L	
B08E0406	4	6	11	35,5	50
B08E0608	6	8	13	39	50

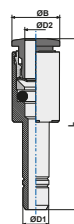

ART. B10 Passaparete
Bulkhead connector

CODICE	ØD	ØC	M	Imax	L		
B100400	4	3	11x1	8	32	14	50
B100600	6	5	14x1	8	36,1	17	50
B100800	8	7	16x1	10	38	18	50
B101000	10	9	18x1	12	42,3	21	25
B101200	12	11	22x1	17	45,8	26	25
B101400	14	13	24x1	18	47,5	27	25

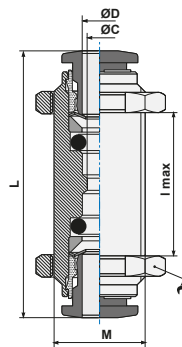

ART. B10L

 Passaparete ad L
L bulkhead

CODICE	ØD	M	H	L1	L2			
B10L0400	4	M11x1	12,5	25,5	20	13	13	50
B10L0600	6	M14x1	15	28	21	17	17	50
B10L0800	8	M16x1	17	30,5	24	18	18	50
B10L1000	10	M18x1	19	35	27	21	21	25

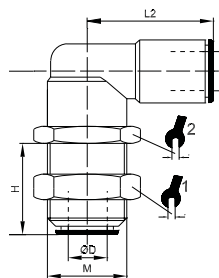
ART. B13

 Anello semplice
Single banjo body

CODICE	ØD	G*	ØA	ØB	H	L	
B1304M5	4	M5	5	8	9	19,5	50
B130418	4	1/8	9,9	14	15	21,1	50
B130618	6	1/8	9,9	14	15	24,3	50
B130614	6	1/4	13,3	18	17	25,5	50
B130818	8	1/8	9,9	14	15	24,8	50
B130814	8	1/4	13,3	18	17	26,5	50
B130838	8	3/8	16,75	21	20	28,0	50
B131014	10	1/4	13,3	18	17	28,4	50
B131038	10	3/8	16,75	21	20	29,9	25
B131214	12	1/4	13,3	18	17	30,9	25
B131238	12	3/8	16,75	21	20	31,4	25
B131212	12	1/2	21	26	24	34,9	25
B13R04M5	4	M5	6	8	9	19,5	50
B13R06M5	6	M5	6	8	9	22,5	50

 (*) G = filetto vite/asta
 (*) G = steam thread

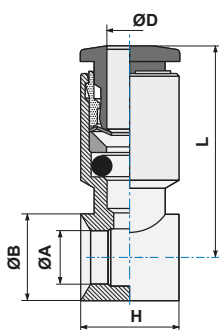
 Vedi capitolo Astine pag. 39
 See page 39 of Stems section

ART. B15

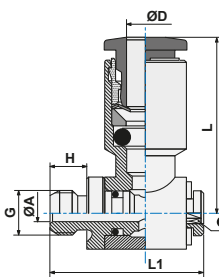

 Anello semplice girevole con asta
Complete single banjo (rotating under pressure)

CODICE	ØD	G	ØA	H	L1	L		
B1504M5	4	M5	2	4	16,8	19,5	2,5	50
B1504M6	4	M6	2	4	17,8	19,5	2,5	50
B150418	4	1/8	5,5	5,5	25	21,1	3	50
B1506M5	6	M5	2	4	16,5	22	2,5	50
B150618	6	1/8	5,5	5,5	24,5	24,3	3	50
B150614	6	1/4	7,8	6,5	28	25,5	4	50
B150818	8	1/8	5,5	5,5	24,5	24,8	3	50
B150814	8	1/4	7,8	6,5	28	26,5	4	50
B150838	8	3/8	10	7,5	32,5	28	5	25
B151014	10	1/4	7,8	6,5	28	28,4	4	25
B151038	10	3/8	10	7,5	32,5	29,9	5	25
B151214	12	1/4	7,8	6,5	28	30,9	4	25
B151238	12	3/8	10	7,5	32,5	31,4	5	25
B151212	12	1/2	12	9	40,8	34,9	8	10



ART. B19

Raccordo ad L fisso
L male adaptor

CODICE	ØD	G	ØB	E	L		
B190418	4	1/8	9	18,6	16,5	10	100
B190618	6	1/8	11	23,8	16,5	10	100
B190614	6	1/4	11	25,3	22,5	11	100
B190818	8	1/8	13	25,5	18,5	11	100
B190814	8	1/4	13	25,5	22,0	11	100
B191014	10	1/4	16	28,0	24,0	13	50

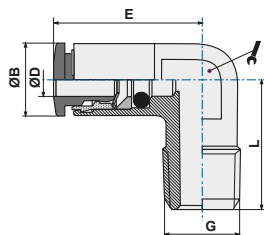

ART. B20

Raccordo a T centrale girevole
Swivel male stud T parallel

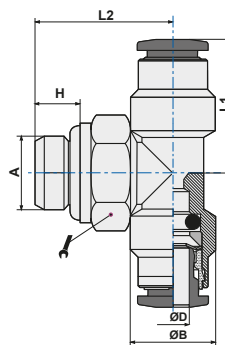

CODICE	ØD	A	H	ØB	L1	L2		
B2004M5	4	M5	4	9	17,3	20,0	8	50
B200418	4	1/8	5,5	11,40	17,3	18,5	13	50
B200414	4	1/4	6,5	9	19,0	22,5	16	50
B2006M5	6	M5	4	11,20	20,5	21	8	50
B200618	6	1/8	5,5	11	19,5	18,5	13	50
B200614	6	1/4	6,5	11	22,1	22,5	16	50
B200818	8	1/8	5,5	13	23,0	20,5	13	50
B200814	8	1/4	6,5	13	23,0	22,5	16	50
B200838	8	3/8	7,5	13	24,5	25,5	18	25
B201014	10	1/4	6,5	16	26,4	24,5	16	25
B201038	10	3/8	7,5	16	26,4	25,5	18	25

NOTA: articolo di importazione - NOTE: imported item



ART. B21

Raccordo a T laterale girevole
Swivel male branch T parallel

CODICE	ØD	G	H	ØB	L1	L2		
B2104M5*	4	M5	4	8	16,5	19	9	100
B210418	4	G1/8	6	13	18,5	17,5	13	100
B210414	4	G1/4	8	16	22,5	19	13	100
B210618	6	G1/8	6	13	20	21	13	100
B210614	6	G1/4	8	16	24	21	13	100
B210818	8	G1/8	6	13	20	23	13	100
B210814	8	G1/4	8	16	24	23	13	100
B210838	8	G3/8	9	20	25,5	23	13	50
B211014*	10	G1/4	8	16	24	27	16	50

* = Art. di importazione
* = Imported item

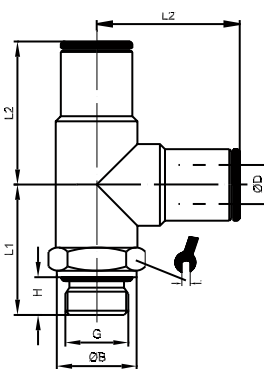

ART. B22

 Gomito girevole filetto cilindrico maschio con O-Ring
Swivel L male adaptor parallel

CODICE	ØD	A	H	ØB	L1	L2		
B2204M5	4	M5	4	9,1	17,3	14,8	9	100
B2204M12	4	M12x1,5	8	9,1	18,0	20,0	13	100
B220418	4	1/8	6	9,1	18,0	20,0	13	100
B220414	4	1/4	8	9,1	18,0	24,0	13	100
B220438	4	3/8	9	9,1	18,0	25,5	13	100
B2206M5	6	M5	4	11	14,5	21,0	9	100
B2206M12	6	M12x1,5	8	11	23,0	25,5	13	100
B220618	6	1/8	6	11	23,0	20,0	13	100
B220614	6	1/4	8	11	23,0	24,0	13	100
B220638	6	3/8	9	11	23,0	25,5	13	100
B2208M12	8	M12x1,5	8	13	25,5	25,5	13	100
B220818	8	1/8	6	13	25,5	20,3	13	100
B220814	8	1/4	8	13	25,5	24,3	13	100
B220838	8	3/8	9	13	25,5	25,8	13	50
B221014	10	1/4	8	16	27,0	26,0	16	50
B221038	10	3/8	9	16	27,0	27,5	16	50
B221012	10	1/2	11	16	27,0	27,5	16	50
B221214	12	1/4	8	19	29,0	30,5	16	25
B221238	12	3/8	9	19	29,0	28,5	20	25
B221212	12	1/2	11	19	29,0	33,5	20	25
B221438	14	3/8	9	21	32,0	28,5	20	25
B221412	14	1/2	11	21	32,0	33,5	20	25

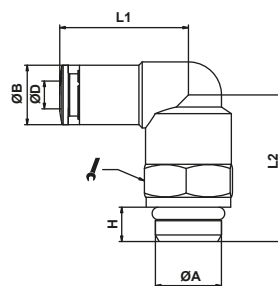
ART. B22L

 Gomito girevole cilindrico lungo
Swivel longer L male adaptor parallel

CODICE	ØD	G	ØB	H	L1	L2		
B22L04M5	4	M5	8	4	23,5	18	9	25
B22L0418	4	G1/8	13	6	33	20	13	25
B22L0414	4	G1/4	16	8	38	20	13	25
B22L06M5	6	M5	8	4	23,5	21	9	25
B22L0618	6	G1/8	13	6	33	21	13	25
B22L0614	6	G1/4	16	8	38	21	13	25
B22L0818	8	G1/8	13	6	33	24	13	25
B22L0814	8	G1/4	16	8	38	24	13	25
B22L1014	10	G1/4	16	6,5	37	26,5	16	25

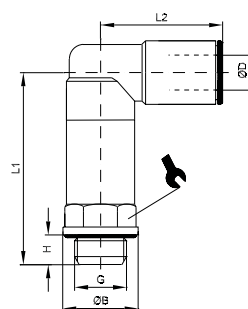
ART. B22L0

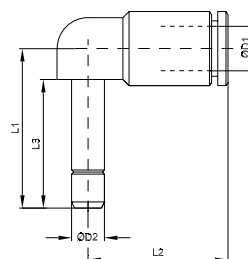

 Gomito innestabile con codolo
Plug-in L connector

CODICE	ØD1	ØD2	L1	L2	L3	
B2204L0	4	4	19,5	18	15,5	50
B2206L0	6	6	26,5	20	18	50
B2208L0	8	8	31	24	19,5	50
B2210L0	10	10	41	25	24	25
B2212L0	12	12	29	28	25	25



ART. B25

Passaparete femmina
Female bulkhead

CODICE	ØA	C	ØB	D	E	L		
B250418	4	1/8	M12x1	15,5	8,5	24,0	14	25
B250618	6	1/8	M14x1	15,8	8,5	26,8	15	25
B250614	6	1/4	M14x1	15,8	11,0	29,5	17	25
B250818	8	1/8	M16x1	16,0	8,5	26,5	19	25
B250814	8	1/4	M16x1	16,0	11,0	32,0	19	25

NOTA: articolo di importazione - NOTE: imported item

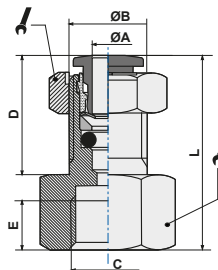

ART. B27

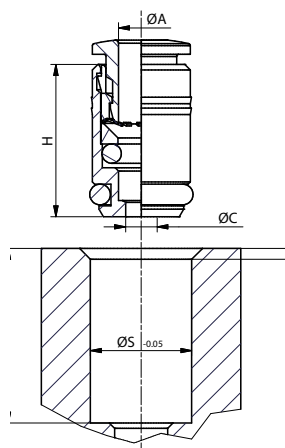

Cartuccia
Cartridge

CODICE	ØD	ØC	H	ØS	L	
B270400	4	2,9	14	9,1	13,5	100
B270600	6	5	16	11,1	15,5	50
B270800	8	7	17	13,6	16,5	50



ART. B33

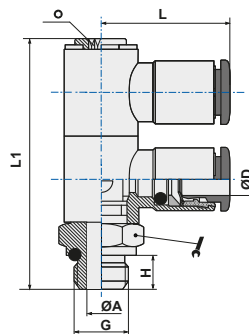

Doppio anello semplice girevole con asta
Swivel double banjo stem

CODICE	ØD	G	ØA	H	L1	L			
B330418	4	1/8	5,5	5,5	43,8	21,1	14	3	25
B330618	6	1/8	5,5	5,5	43,8	24,3	14	3	25
B330614	6	1/4	7,8	7,5	51,5	25,5	18	4	25
B330818	8	1/8	5,5	5,5	43,8	24,8	14	3	25
B330814	8	1/4	7,8	7,5	51,5	26,5	18	4	25
B331014	10	1/4	7,8	7,5	51,5	28,4	18	4	25



ART. B34

Triplo anello semplice girevole con asta
Swivel triple banjo stem

CODICE	ØD	G	ØA	H	L1	L			
B340418	4	1/8	5,5	5,5	58,4	21,1	14	3	10
B340618	6	1/8	5,5	5,5	58,4	24,3	14	3	10
B340614	6	1/4	7,8	7,5	67	25,5	18	4	10
B340818	8	1/8	5,5	5,5	58,4	24,8	14	3	10
B340814	8	1/4	7,8	7,5	67	26,5	18	4	10
B341014	10	1/4	7,8	7,5	67	51,5	18	4	10

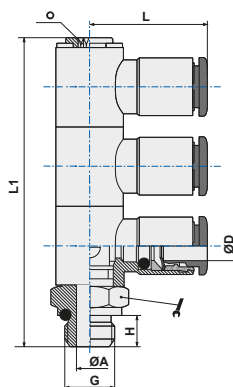

ART. 010T

Diritto filetto cilindrico mschio con O-Ring
Straight male adaptor (parallel)

CODICE	ØD	G	ØC	ØB	H	L			
010T04M5	4	M5	2,6	9	4	20,5	Ø9	2,5	100
010T04M6	4	M6	2,6	9	5	20,5	Ø9	2,5	50
010T0418	4	1/8	2,6	13,5	5,5	20	9	2,5	50
010T0414	4	1/4	2,6	17	6,5	21	9	2,5	50
010T06M5	6	M5	2,6	11	4	22,8	Ø11	2,5	50
010T06M6	6	M6	2,6	11	5	24,8	Ø11	2,5	50
010T0618	6	1/8	4,2	13,5	5,5	25,3	11	4	50
010T0614	6	1/4	4,2	17	6,5	24,3	11	4	50
010T0818	8	1/8	5,2	12,8	5,5	27	13	5	50
010T0814	8	1/4	6,2	17	6,5	25,5	13	6	50
010T0838	8	3/8	6,2	20	7,5	25,5	13	6	50
010T0812	8	1/2	6,2	24	10	25	14	6	25
010T1014	10	1/4	7,3	16	6,5	30,4	16	7	50
010T1038	10	3/8	8,3	21	7,5	30,9	16	8	50
010T1012	10	1/2	14,1	23	10	24,7	17	8	25
010T1214	12	1/4	7,3	16	6,5	33,2	19	7	25
010T1238	12	3/8	10,3	22	7,5	33,2	19	10	25
010T1212	12	1/2	10,3	24	9	33,2	19	10	25
010T1438	14	3/8	10,3	21	7,5	35	19	10	25
010T1412	14	1/2	12,3	25	9	35	19	12	25

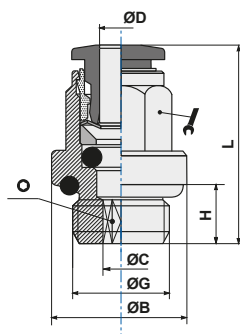

ART. 020T

Diritto femmina
Straight female adaptor

CODICE	ØD	G	ØC	ØB	H	L		
020T0418	4	1/8	3	12	6,5	26,5	9	50
020T0414	4	1/4	3	17	10	29,5	9	50
020T0618	6	1/8	5	12	6,5	28,3	11	50
020T0614	6	1/4	5	17	10	31,3	11	50
020T0818	8	1/8	7	12	6,5	28,5	13	50
020T0814	8	1/4	7	17	10	32,5	13	50

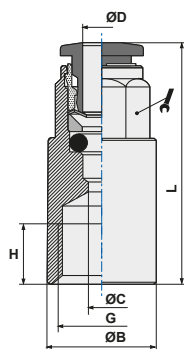

ART. 030T

Diritto innestabile
Straight connector

CODICE	ØD	ØD1	ØB	ØC	L	
030T0400	4	4	3	11	32	50
030T0600	6	6	5	13	36,1	50
030T0800	8	8	7	15	38	50
030T1000	10	10	9	18	42,3	50
030T1200	12	12	11	21	45,8	25
030T1400	14	14	13	23	48,9	25

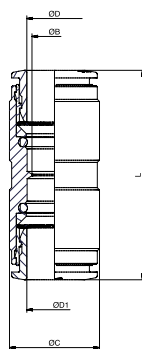

ART. 040T

Gomito innestabile
L connector

CODICE	ØD	ØC	ØB	L	
040T0400	4	3	10	19	50
040T0600	6	5	11	20,6	50
040T0800	8	7	13	23	50
040T1000	10	8	16	26,4	50
040T1200	12	10	19	28,9	25
040T1400	14	12	21	31,5	25

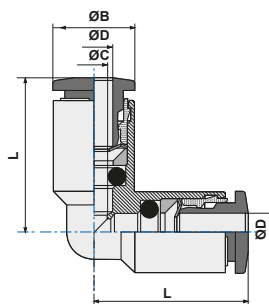

ART. 040TLO

Gomito innestabile con codolo
Plug-in L connector

CODICE	ØD1	ØD2	L1	L2	L3	
040T04L0	4	4	34,5	18	16,7	50
040T06L0	6	6	42,5	23	19,5	50
040T08L0	8	8	46,5	25,5	21	50
040T10L0	10	10	51	27	24	25
040T12L0	12	12	54	29	25	25

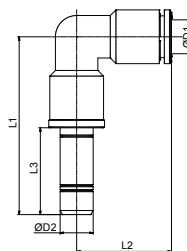

ART. 050T

T innestabile
T connector

CODICE	ØD	ØC	ØB	L	
050T0400	4	3	9	17,3	50
050T0600	6	5	11	20,6	50
050T0800	8	7	13	23	50
050T1000	10	8	16	26,4	25
050T1200	12	10	19	28,9	25
050T1400	14	12	21	31,5	10

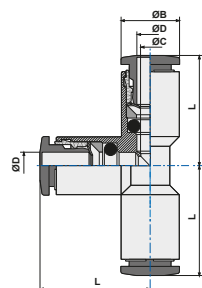

ART. 080T

Riduzione con codolo
Plug-in reducer

CODICE	ØD1	ØD2	ØB	L	
080T0604	6	4	9	32,5	50
080T0804	8	4	9	34	50
080T0806	8	6	11	36	50
080T1006	10	6	11	39,3	50
080T1008	10	8	13	39	50
080T1208	12	8	13	39,5	25
080T1210	12	10	16	41,4	25
080T1406	14	6	15	43,8	25

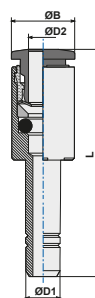

ART. 080T/E

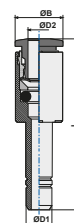

Maggiorazione con codolo
Plug-in increaser

CODICE	ØD1	ØD2	ØB	L	
080TE0406	4	6	11	35,5	50
080TE0608	6	8	13	39	50



ART. 100T

Passaparete
Bulkhead connector

CODICE	ØD	ØC	M	I _{max}	L		
100T0400	4	3	11x1	8	32	14	50
100T0600	6	5	14x1	8	36,1	17	50
100T0800	8	7	16x1	10	38	18	50
100T1000	10	9	18x1	12	42,3	21	25
100T1200	12	11	22x1	17	45,8	26	25
100T1400	14	13	24x1	18	47,5	27	25

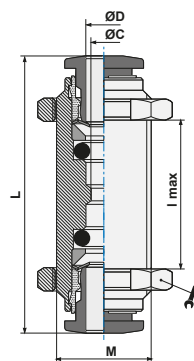

ART. 100TL

 Passaparete ad L
L bulkhead

CODICE	ØD	M	H	L1	L2			
100TL0400	4	M11x1	12,5	25,5	20	13	13	50
100TL0600	6	M14x1	15	28	21	17	17	50
100TL0800	8	M16x1	17	30,5	24	18	18	50
100TL1000	10	M18x1	19	35	27	21	21	25

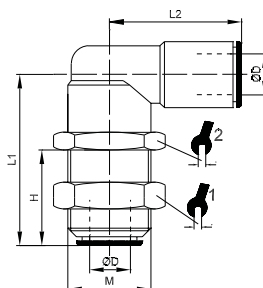
ART. 130T

 Anello semplice
Single banjo body

CODICE	ØD	G*	ØA	ØB	H	L	
130T04M5	4	M5	5	8	9	19,5	50
130T0418	4	1/8	9,9	14	15	21,1	50
130T0618	6	1/8	9,9	14	15	24,3	50
130T0614	6	1/4	13,3	18	17	25,5	50
130T0818	8	1/8	9,9	14	15	24,8	50
130T0814	8	1/4	13,3	18	17	26,5	50
130T0838	8	3/8	16,75	21	20	28,0	50
130T1014	10	1/4	13,3	18	17	28,4	50
130T1038	10	3/8	16,75	21	20	29,9	25
130T1214	12	1/4	13,3	18	17	30,9	25
130T1238	12	3/8	16,75	21	20	31,4	25
130T1212	12	1/2	21	26	24	34,9	25
130TR04M5	4	M5	6	8	9	19,5	50
130TR06M5	6	M5	6	8	9	22,5	50

 (*) G = filetto vite/asta
 (*) G = steam thread

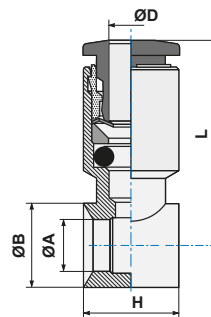
 Vedi capitolo Astine pag. 39
 See page 39 of Stems section

ART. 150T

 Anello semplice girevole con asta
Complete single banjo (rotating under pressure)

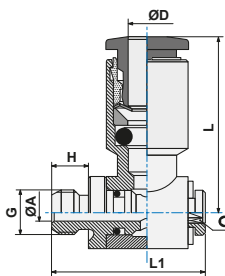
CODICE	ØD	G	ØA	H	L1	L		
150T04M5	4	M5	2	4	16,8	19,5	2,5	50
150T04M6	4	M6	2	4	17,8	19,5	2,5	50
150T0418	4	1/8	5,5	5,5	25	21,1	3	50
150T06M5	6	M5	2	4	16,5	22	2,5	50
150T0618	6	1/8	5,5	5,5	24,5	24,3	3	50
150T0614	6	1/4	7,8	6,5	28	25,5	4	50
150T0818	8	1/8	5,5	5,5	24,5	24,8	3	50
150T0814	8	1/4	7,8	6,5	28	26,5	4	50
150T0838	8	3/8	10	7,5	32,5	28	5	25
150T1014	10	1/4	7,8	6,5	28	28,4	4	25
150T1038	10	3/8	10	7,5	32,5	29,9	5	25
150T1214	12	1/4	7,8	6,5	28	30,9	4	25
150T1238	12	3/8	10	7,5	32,5	31,4	5	25
150T1212	12	1/2	12	9	40,8	34,9	8	10



ART. 190T

Raccordo ad elle fisso
L male adaptor

CODICE	ØD	G	ØB	E	L		
190T0418	4	1/8	9	18,6	16,5	10	100
190T0618	6	1/8	11	23,8	16,5	10	100
190T0614	6	1/4	11	25,3	22,5	11	100
190T0818	8	1/8	13	25,5	18,5	11	100
190T0814	8	1/4	13	25,5	22,0	11	100
190T1014	10	1/4	16	28,0	24,0	13	50

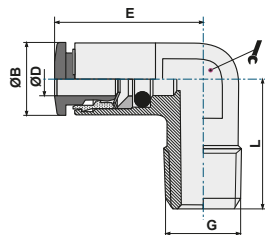

ART. 220T

Gomito girevole filetto cilindrico maschio con O-Ring
Swivel L male adaptor parallel

CODICE	ØD	A	H	ØB	L1	L2		
220T04M5	4	M5	4	9,1	17,3	14,8	9	100
220T04M12	4	M12x1,5	8	9,1	18,0	20,0	13	100
220T0418	4	1/8	6	9,1	18,0	20,0	13	100
220T0414	4	1/4	8	9,1	18,0	24,0	13	100
220T0438	4	3/8	9	9,1	18,0	25,5	13	100
220T06M5	6	M5	4	11	14,5	21,0	9	100
220T06M12	6	M12x1,5	8	11	23,0	25,5	13	100
220T0618	6	1/8	6	11	23,0	20,0	13	100
220T0614	6	1/4	8	11	23,0	24,0	13	100
220T0638	6	3/8	9	11	23,0	25,5	13	100
220T08M12	8	M12x1,5	8	13	25,5	25,5	13	100
220T0818	8	1/8	6	13	25,5	20,3	13	100
220T0814	8	1/4	8	13	25,5	24,3	13	100
220T0838	8	3/8	9	13	25,5	25,8	13	50
220T1014	10	1/4	8	16	27,0	26,0	16	50
220T1038	10	3/8	9	16	27,0	27,5	16	50
220T1012	10	1/2	11	16	27,0	27,5	16	50
220T1214	12	1/4	8	19	29,0	30,5	16	25
220T1238	12	3/8	9	19	29,0	28,5	20	25
220T1212	12	1/2	11	19	29,0	33,5	20	25
220T1438	14	3/8	9	21	32,0	28,5	20	25
220T1412	14	1/2	11	21	32,0	33,5	20	25

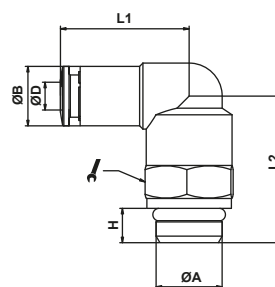

ART. 22LOT

Gomito innestabile con codolo
Plug-in L connector

CODICE	ØD	G	ØB	H	L1	L2		
22LOT4M5	4	M5	8	4	23,5	18	9	25
22LOT418	4	G1/8	13	6	33	20	13	25
22LOT414	4	G1/4	16	8	38	20	13	25
22LOT6M5	6	M5	8	4	23,5	21	9	25
22LOT618	6	G1/8	13	6	33	21	13	25
22LOT614	6	G1/4	16	8	38	21	13	25
22LOT818	8	G1/8	13	6	33	24	13	25
22LOT814	8	G1/4	16	8	38	24	13	25
22LOT1014	10	G1/4	16	8	37	26,5	16	25

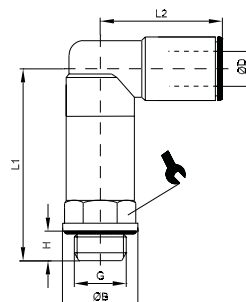



ART. 220TLO

 Gomito innestabile con codolo
Plug-in L connector

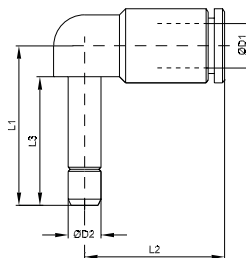
CODICE	ØD1	ØD2	L1	L2	L3	
22OT04L0	4	4	19,5	18	15,5	50
22OT06L0	6	6	26,5	20	18	50
22OT08L0	8	8	31	24	19,5	50
22OT10L0	10	10	41	25	24	25
22OT12L0	12	12	29	28	25	25



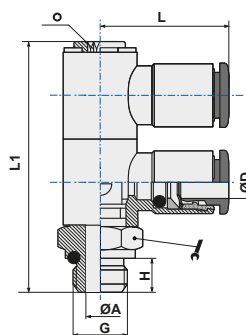

ART. 330T

 Doppio anello semplice girevole con asta
Swivel double banjo stem

CODICE	ØD	G	ØA	H	L1	L			
33OT0418	4	1/8	5,5	5,5	43,8	21,1	14	3	25
33OT0618	6	1/8	5,5	5,5	43,8	24,3	14	3	25
33OT0614	6	1/4	7,8	7,5	51,5	25,5	18	4	25
33OT0818	8	1/8	5,5	5,5	43,8	24,8	14	3	25
33OT0814	8	1/4	7,8	7,5	51,5	26,5	18	4	25
33OT1014	10	1/4	7,8	7,5	51,5	28,4	18	4	25

ART. 340T

 Triplo anello semplice girevole con asta
Swivel triple banjo stem

CODICE	ØD	G	ØA	H	L1	L			
34OT0418	4	1/8	5,5	5,5	58,4	21,1	14	3	10
34OT0618	6	1/8	5,5	5,5	58,4	24,3	14	3	10
34OT0614	6	1/4	7,8	7,5	67	25,5	18	4	10
34OT0818	8	1/8	5,5	5,5	58,4	24,8	14	3	10
34OT0814	8	1/4	7,8	7,5	67	26,5	18	4	10
34OT1014	10	1/4	7,8	7,5	67	51,5	18	4	10

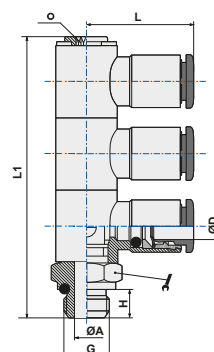

BREVE DESCRIZIONE

I raccordi automatici della nostra serie RAP sono realizzati in Italia, a garanzia di elevati standard di qualità secondo le normative ISO di riferimento e rispondono alle seguenti specifiche tecniche e applicative.

SHORT DESCRIPTION

The RAP series push-in fittings are produced in Italy according to the reference ISO norms as warranty of high quality level and answer to the followings technical specifications and applications.

SCHEMA TECNICA TECHNICAL SHEET

FLUIDI UTILIZZABILI <i>EMPLOYABLE FLUIDS</i>		Aria compressa (per altri fluidi contattare il nostro Ufficio Tecnico) <i>Compressed air (for different fluid pls contact our Technical Dept.)</i>
APPLICAZIONI <i>APPLICATIONS</i>		Pneumatica, idraulica a bassa pressione, secondo normativa DIN 3861-3870. Idonei al funzionamento con il vuoto. <i>Pneumatic circuits, low pressure hydraulic applications, according to DIN 3861-3870 norms. Suitable for vacuum applications.</i>
TUBI CONSIGLIATI <i>SUGGESTED TUBES</i>		TPU (Poliuretano), PA11/PA12 (Poliammide), TPE (Polietilene), TCO (Copoliestere) <i>TPU (Polyurethane), PA11/PA12 (Polyamide), TPE (Polyethylene), TCO (Copolyester)</i>
TOLLERANZE TUBI <i>TUBES TOLERANCES</i>		Diam. da 4 a 10 mm +/- 0,05 Diam. da 12 mm +/- 0,1 <i>Diam. between 4 and 10 mm +/- 0,05 Diam. from 12 mm +/- 0,1</i>
GRADO DI PROTEZIONE <i>INGRESS PROTECTION</i>		"" IP 68 ""
TEMPERATURE E PRESSIONI <i>TEMPERATURE AND PRESSURE</i>	VALORI LIMITE CONSIGLIATI <i>RECOMMENDED LIMIT VALUES</i>	Le temperature e le pressioni dipendono generalmente dalle caratteristiche del tubo impiegato, e comunque si suggerisce di non superare i 15 bar e temperature comprese fra -20°C e +70°C. <i>Temperatures and pressures usually depend by the technical features of the employed tubes, anyway it is suggested a limit working pressure of 15 bar and a temperature range between -20°C and +70°C</i>
	DATI TECNICI DI PROVA <i>TECHNICAL TESTING DATA</i>	A pag. 34 sono riportati i dati di resistenza a trazione e i valori limite di utilizzo (Pressione e Temperature) relativi ai principali tubi commerciali. <i>At page 34 are indicated the load traction resistance values and the main working and breaking limit (Pressure and Temperature) of the main commercial tubing.</i>
	NOTA <i>NOTE</i>	Per dati più puntuali consultare il catalogo tecnico del proprio fornitore di tubi. <i>For more complete informations pls read the technical catalogue of your tube supplier.</i>
FILETTATURE <i>THREAD TYPE</i>		BSP cilindrica UNI-ISO 228; BSP conica UNI-ISO 7; Metrica ISO/R 262. <i>BSP parallel UNI-ISO 228; BSP tapered UNI-ISO 7; Metric ISO/R 262</i>
MATERIALI <i>MATERIALS</i>	corpo, spintore "OT", astine e basi girevoli <i>body, "OT" sleeve, stems and swivel bases</i>	Ottone UNI EN 12164 CW614N <i>Brass UNI EN 12164 CW614N</i>
	spintore, distanziale, sottomolla <i>sleeve, collar and back ring</i>	POM copolimero ISO1043-1 <i>POM copolymer ISO1043-1</i>
	pinza <i>spring</i>	Acciaio Inox AISI 301 austenitico <i>Stainless steel AISI 301 austenitic</i>
	guarnizioni tenuta <i>seals</i>	NBR 70 DWGV-EN549 UL157 <i>NBR 70 DWGV-EN549 UL157</i>

INFORMAZIONI TECNICHE AGGIUNTIVE

Ogni lotto della serie RAP viene sottoposto a controlli cosiddetti "rompilotto" durante tutto il ciclo produttivo, che comprendono, oltre all'osservazione estetica, la verifica di funzionalità e di eventuali perdite, un test in pressione a 8 bar per verificarne la conformità anche in condizioni di utilizzo nominali. Successivamente viene eseguito un test a campione di rottura (simulazione scoppio a 50 bar di pressione) con una macchina dedicata che sollecita il raccordo a trazione. Di seguito viene indicata la forza minima di strappo (in Newton) ammessa per ogni diametro:

Diam. tubo <i>Tube diam.</i>	Forza di strappo <i>Breaking load</i>
Ø4	63 N
Ø6	141 N
Ø8	251 N
Ø10	393 N
Ø12	566 N
Ø14	750 N

Nota importante:

I valori indicati si riferiscono alla tenuta della pinza di aggraffaggio, "core part" sia del raccordo RAP in ottone, che del Tecno-RAP in tecnopolimero, per cui omogenei. I valori di rottura sperimentali misurati sono stati, in base al diametro, anche da 1,2 a 2,5 volte superiori.

Informazioni complementari sulle temperature di utilizzo:

Pressione di esercizio e pressione di scoppio (bar) alle diverse temperature Working pressure and breaking pressure (bar) at different temperatures						
Esempio Example	T-20°C	T-20°C	T+23°C	T+23°C	T+60°C	T+60°C
Tubo 6x4 colorato Tube 6x4 colored	P esercizio bar working P bar	P scoppio bar breaking P bar	P esercizio bar working P bar	P scoppio bar breaking P bar	P esercizio bar working P bar	P scoppio bar breaking P bar
TPU	18,7	74,8	10,0	40,0	5,2	20,8
PA11	37,4	149,6	20,0	80,0	10,4	41,6
PA12	48,6	168,3	26,0	90,0	10,4	36,0
PE	18,7	74,8	10,0	40,0	5,0	20,0

Tutte le necessarie valutazioni sull'utilizzo dei raccordi in condizioni di esercizio differenti da quelle suggerite nella scheda tecnica iniziale debbono anche tenere conto, con riferimento alle temperature, dei dati nominali relativi al tubo utilizzato e del limite imposto dal componente più critico.

SERIE TECNORAP: -20°+50° • SERIE RAP : -20° +70°
 SERIE OT: -20° + 80° • SERIE OV : -20° +150°
 SERIE SS:-20° +120°

ADDITIONAL TECHNICAL INFORMATION

Each RAP production batch is tested according to severe cyclics "lot breaker" controls along all the production period, which include shape observation, leakage verification, functionality, at the working pressure of 8 bar.

Then all samples taken from the lot are tested by a traction machine which simulate a breaking pressure of 50 bar.

Here below are indicated the traction loads (in Newton) for each size:

Important note:

The values refer to the resistance of the crimping gripper, "core part" of both fittings, the brass RAP and the technopolymer Tecno-RAP, whereby homogeneous. The breaking experimental values measured, according to the diameter, were from 1.2 to 2.5 times higher.

Additional information regarding the working temperatures:

Further to all the necessary assessments on the use of the fittings in operating conditions different from how suggested in the initial technical sheet must be considered, with reference to temperatures, the nominal data regarding the type of the used tube and the limit imposed by the most critical component.

SERIES TECNORAP: -20°+50° • SERIES RAP : -20° +70°
 SERIES OT: -20° + 80° • SERIES OV : -20° +150°
 SERIES SS:-20° +120°



1 ANELLO DI SOSTEGNO
LOCK RING

2 PINZA DI AGGRAFFAGGIO
CRIMPING GRIPPER

3 DISTANZIALE DI FERMO
LOCK RING

4 ANELLO SPINGITORE
THRUST SLEEVE

5 O-RING DI TENUTA
O-RING SEAL

6 BASE GIREVOLE
SWIVEL BASE

7 CORPO DEL RACCORDO
FITTING BODY

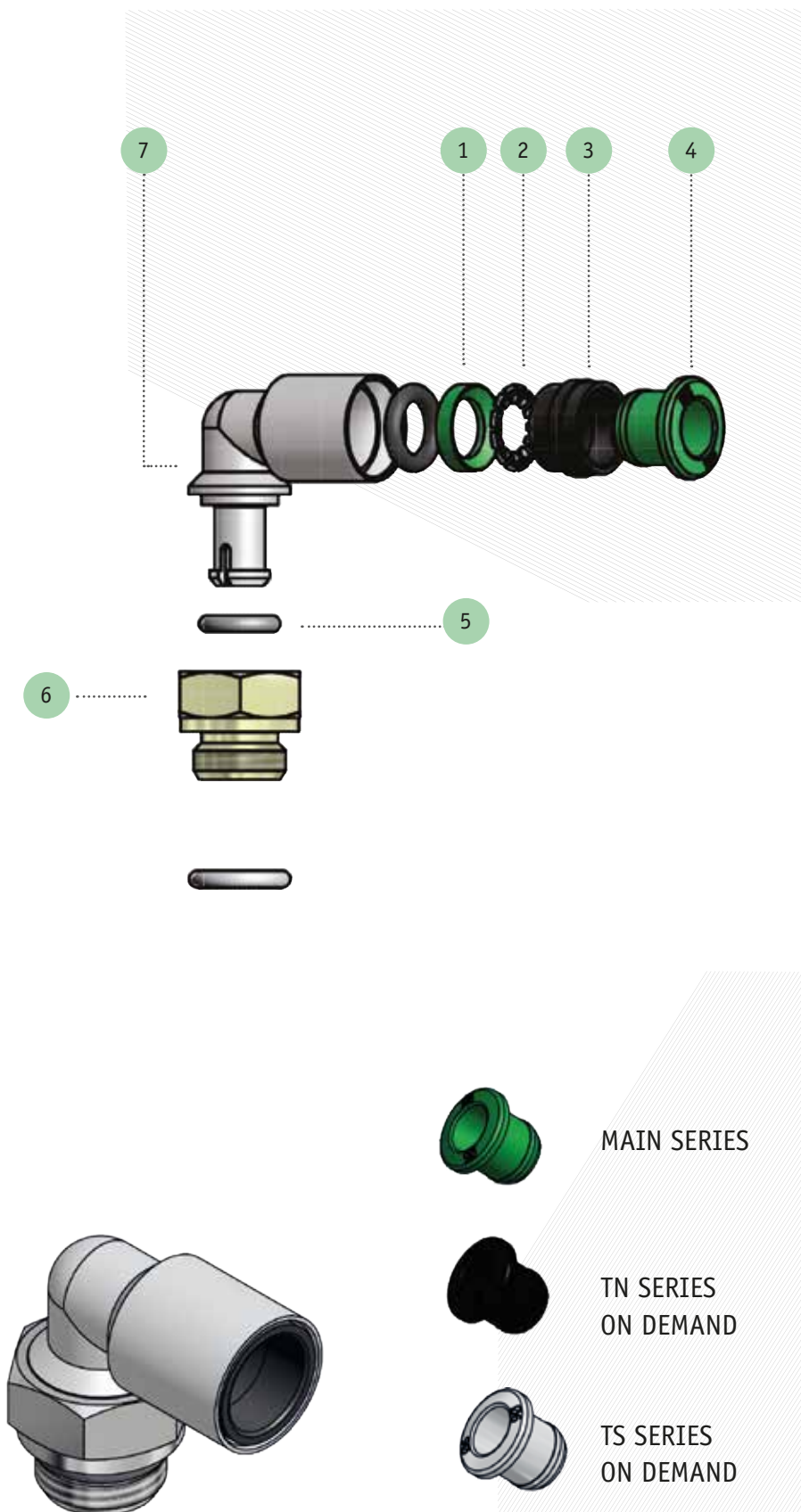

MAIN SERIES



TN SERIES
ON DEMAND



TS SERIES
ON DEMAND



TA SERIES
ON DEMAND

ART. T01

Diritto filetto cilindrico maschio con O-Ring
Straight male adaptor (parallel)

CODICE	ØD	G	ØC	ØB	H	L			
T0104M10	4	M10x1,5	2,5	14,0	7,5	21,3	10	2,5	50
T010418	4	1/8	2,5	14,0	5,5	19,0	10	2,5	50
T010414	4	1/4	2,5	17,5	6,5	20,8	10	2,5	50
T0106M10	6	M10x1,5	4,0	14,0	7,5	26,8	12	4,0	50
T010618	6	1/8	4,0	14,0	5,5	24,5	12	4,0	50
T010614	6	1/4	4,0	17,5	6,5	26,0	12	4,0	50
T0108M10	8	M10x1,5	6,0	14,0	7,5	28,1	14	5,0	50
T010818	8	1/8	5,0	14,0	5,5	25,7	14	5,0	50
T010814	8	1/4	6,0	17,5	6,5	27,2	14	6,0	50
T011014	10	1/4	7,0	17,5	6,5	28,7	18	7,0	50

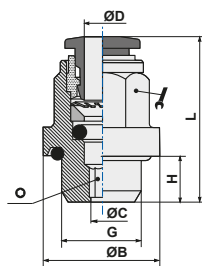

ART. T03

Diritto innestabile
Straight connector

CODICE	ØD	ØD1	ØC	ØB	ØB1	L	
T030400	4	4	3	9,5	9,5	32,0	50
T030406	4	6	3	9,5	11,5	32,5	50
T030600	6	6	5	11,5	11,5	35,6	50
T030608	6	8	5	11,5	13,5	36,0	50
T030800	8	8	7	13,5	13,5	38,0	50
T030810	8	10	7	13,5	17,0	32,5	50
T031000	10	10	9	17,0	17,0	42,3	50
T031012	10	12	9	17,0	20,0	44,0	50
T031200	12	12	10	20,0	20,0	46,2	25

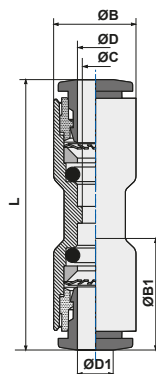

ART. T04

Gomito innestabile
L connector

CODICE	ØD	ØC	ØB	L	ØE	
T040400	4	3	9,5	17,2	3,2	50
T040600	6	5	11,5	20,8	3,2	50
T040800	8	7	13,5	23,0	3,2	50
T041000	10	9	17,0	26,4	4,3	50
T041200	12	10	20,0	28,9	4,2	25

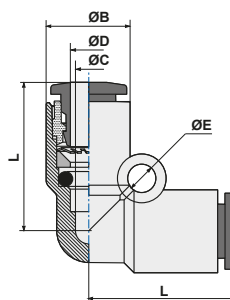

ART. T04LO

Gomito innestabile con codolo
Plug-in L connector

CODICE	ØD	ØC	ØB	L	L1	ØA	L2	
T0404L0	4	3	9,5	17,2	20,75	4	16,7	50
T0406L0	6	5	11,5	20,8	24,25	6	19,5	50
T0408L0	8	7	13,5	23,0	27,25	8	21,0	50
T0410L0	10	9	17,0	26,4	31,80	10	24,0	50
T0412L0	12	10	20,0	28,9	36,00	12	25,0	25

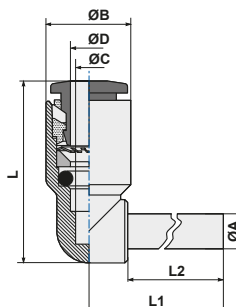

ART. T05

 T Innestabile
T connector

CODICE	ØD	ØD1	ØC	ØB	L		
T050400	4	4	3,0	9,5	17,2		50
T050604*	6	4	5,3	13,0	19,2		50
T050600	6	6	5,0	11,5	20,8		50
T050806*	8	6	7,1	14,4	22,7		25
T050800	8	8	7,0	13,5	23,0		50
T051008*	10	8	9,3	18,4	27,9		25
T051000	10	10	9,0	17,0	26,4		25
T051210*	12	10	10,0	21,0	29,9		10
T051200	12	12	10,0	20,0	28,9		10

* = di importazione - imported

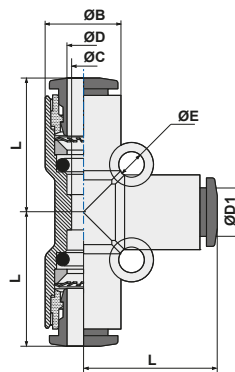
ART. T05LO

 T Innestabile con codolo centrale
Plug-in T connector (center)

CODICE	ØD	ØC	ØB	L	L1	ØA	L2	
T0504L0	4	3	9,5	17,2	20,75	4	16,7	50
T0506L0	6	5	11,5	20,8	24,25	6	19,5	50
T0508L0	8	7	13,5	23,0	27,25	8	21,0	50
T0510L0	10	9	17,0	26,4	31,80	10	24,0	25
T0512L0	12	10	20,0	28,9	36,00	12	25,0	10

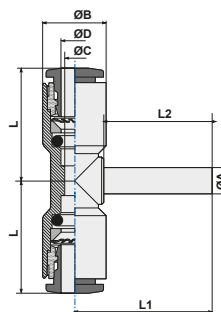
 Art. disponibile fino ad esaurimento scorte
 Item available while stocks last

ART. T05V0

 T Innestabile con codolo laterale
Plug-in T connector (lateral)

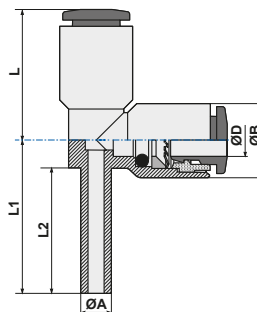
CODICE	ØD	ØB	L	L1	ØA	L2	
T0506V0	6	11,5	20,8	24,25	6	19,5	50
T0508V0	8	13,5	23,0	27,25	8	21,0	50
T0510V0	10	17,0	26,4	31,80	10	24,0	25
T0512V0	12	20,0	28,9	36,00	12	25,0	10

 Art. disponibile fino ad esaurimento scorte
 Item available while stocks last

ART. T08

Riduzione
Reducer

CODICE	ØD1	ØD	ØC	ØB	L	L1	
T080604	6	4	3	9,5	35,5	19,5	50
T080804	8	4	3	9,5	37,0	21,0	50
T081004	10	4	3	9,5	40,0	24,0	25
T081204	12	4	3	9,5	41,0	25,0	25
T080806	8	6	5	11,5	39,05	23,0	50
T081006	10	6	5	11,5	42,05	24,0	25
T081206	12	6	5	11,5	43,05	25,0	25
T081008	10	8	7	13,5	43,0	26,25	25
T081208	12	8	7	13,5	44,0	25,0	25
T081210	12	10	9	17,0	46,15	27,55	25

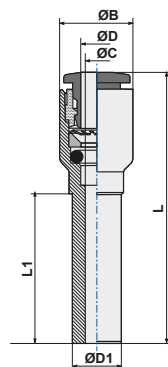

ART. T09

Tappo
Plug

CODICE	ØD	ØB	L	
T090400	4	7,0	25,0	100
T090600	6	9,5	27,5	100
T090800	8	12,0	30,0	100
T091000	10	14,0	32,5	100
T091200	12	16,0	35,0	100

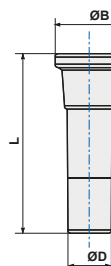

ART. T10

Passaparete
Bulkhead connector

CODICE	ØD	ØB	L	M	I _{max}		
T100400	4	9,5	32,0	11x1	8	14	50
T100600	6	11,5	36,1	14x1	8	17	50
T100800	8	13,5	38,0	16x1	10	18	50
T101000	10	17,5	42,3	20x1	12	24	25
T101200	12	20,0	46,2	22x1	17	26	25

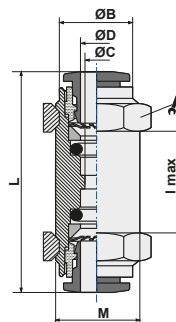

ART. T10L

Passaparete a "L"
L bulkhead

CODICE	ØD	M	B	E	H	L max	CH	
T10L0400	4	12x1	28,5	19,0	14	6	14	25
T10L0600	6	14x1	32,1	19,2	17	7	17	25
T10L0800	8	16x1	39,4	23,0	19	7,5	19	25
T10L1000	10	20x1	44,8	28,2	24	9,5	24	25
T10L1200	12	22x1	46,6	29,5	27	10	26	10

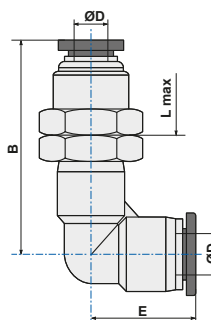

NOTA: articolo di importazione - NOTE: imported item

ART. T11

 Croce intermedio
Cross connector

CODICE	ØD		ØB	ØA	C		
T110400	4		9,5	17,2	3		25
T110600	6		11,5	20,8	3		25
T110800	8		13,5	23,0	3		25
T111000*	10		17,0	6,5	3		10
T111200*	12		20,0	28,8	3		10

* = di importazione - imported

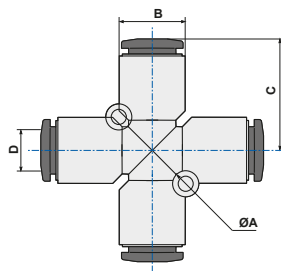

ART. T13

 Anello semplice
Single banjo body

CODICE	ØD	G*	ØC	ØB	ØA	H	L	ØF	
T1304M5	4	M5	3	9,5	5	10	19,5	8,0	50
T130418	4	1/8	3	9,5	9,9	15	21,1	14,0	50
T130618	6	1/8	5	11,5	9,9	15	24,3	14,0	50
T130614	6	1/4	5	11,5	13,3	17	25,5	18,0	50
T130818	8	1/8	7	13,5	9,9	15	24,8	14,0	50
T130814	8	1/4	7	13,5	13,3	17	26,5	18,0	50
T130838	8	3/8	7	13,5	16,75	20	28,0	21,3	50
T131014	10	1/4	9	17,0	13,3	17	28,4	18,0	50
T131038	10	3/8	9	17,0	16,75	20	29,9	21,3	25
T131012	10	1/2	9	17,0	13,3	24	30,0	26,0	25
T131238	12	3/8	10	20,0	16,75	20	31,4	21,3	25
T131212	12	1/2	10	20,0	21	24	34,9	26,0	25
T13R04M5	4	M5	3	9,5	6	10	19,5	8	50
T13R06M5	6	M5	5	11,5	6	10	23	8	50

(*) G = filetto vite/asta
 (*) G = steam thread

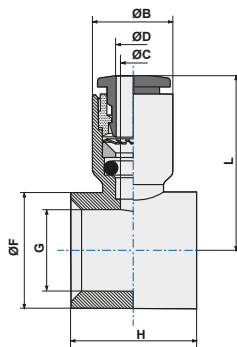
Vedi capitolo Astine pag. 39
 See page 39 of Stems section



ART. T13B

 Anello semplice due vie
Single branch body

CODICE	ØD	G*		H	L	L2	
T13B04M5	4	M5		10	19,5	19	50
T13B0618	6	1/8		15	24,3	23	50
T13B0814	8	1/4		17	26,5	27	50
T13B1038	10	3/8		20	29,9	34	25
T13B1212	12	1/2		24	34,9	40	10

(*) G = filetto vite/asta
 (*) G = steam thread
 H = altezza sede asta - H = stem site length

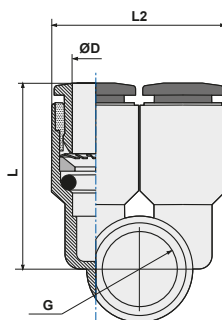
Vedi capitolo Astine pag. 39
 See page 39 of Stems section



ART. T14

Anello doppio
Double banjo body

CODICE	ØD	G*	ØC	ØB	H	ØF	L	
T1404M5	4	M5	3	9,5	10	8,0	19,5	50
T140418	4	1/8	3	9,5	15	14,0	21,1	50
T140814	8	1/4	7	13,5	17	18,0	26,5	50
T140838	8	3/8	7	13,5	20	21,3	28,0	25
T141014	10	1/4	9	17,0	17	18,0	28,4	50
T141038	10	3/8	9	17,0	20	21,3	29,9	25
T141012	10	1/2	9	17,0	24	26,0	30,0	10
T141238	12	3/8	10	20,0	20	21,3	31,4	25
T141212	12	1/2	10	20,0	24	26,0	34,9	10

(*) G = filetto vite/asta
(*) G = steam thread

Vedi capitolo Astine pag. 39
See page 39 of Stems section

Art. disponibile fino ad esaurimento scorte
Item available while stocks last

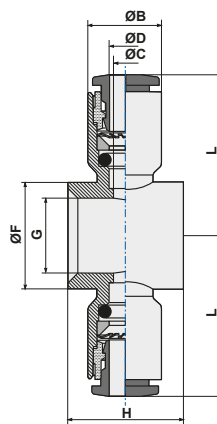

ART. T15

Anello semplice girevole con asta
Complete single banjo (rotating under pressure)

CODICE	ØD	G	ØA	H	L1	L	●	
T1504M5	4	M5	2,0	4,0	17,8	19,5	2,5	50
T1504M6	4	M6	2,0	5,0	18,9	19,5	2,5	50
T150418	4	1/8	5,5	5,5	24,5	21,1	3,0	50
T150618	6	1/8	5,5	5,5	24,5	24,3	3,0	50
T150614	6	1/4	7,8	6,5	28,0	25,5	4,0	50
T150818	8	1/8	5,5	5,5	24,5	24,8	3,0	50
T150814	8	1/4	7,8	6,5	28,0	26,5	4,0	50
T150838	8	3/8	10,0	7,5	32,5	28,0	5,0	25
T151014	10	1/4	7,8	6,5	28,0	28,4	4,0	25
T151038	10	3/8	10,0	7,5	32,5	29,9	5,0	25
T151012	10	1/2	12,0	9,0	38,8	30,0	8,0	10
T151238	12	3/8	10,0	7,5	32,5	31,4	5,0	10
T151212	12	1/2	12,0	9,0	38,8	34,9	8,0	10

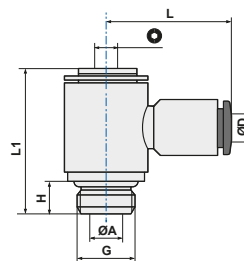

ART. T15C

Anello semplice girevole con asta conico
Complete single banjo tapered

CODICE	ØD	G	A	L	ØK	E		
T15C0418	4	1/8	7,5	23,0	14,4	23,5	12	50
T15C0618	6	1/8	7,5	23,0	14,4	24,0	12	50
T15C0614	6	1/4	9,5	26,5	18,3	25,4	14	50
T15C0638	6	3/8	10,5	32,0	22,0	29,5	19	25
T15C0818	8	1/8	7,5	23,0	14,4	28,9	14	50
T15C0814	8	1/4	9,5	26,5	18,3	29,1	14	50
T15C0838	8	3/8	10,5	32,0	22,0	30,0	19	25
T15C1014	10	1/4	9,5	26,5	18,3	33,0	14	25
T15C1038	10	3/8	10,5	32,0	22,0	33,5	19	25
T15C1012	10	1/2	13,5	38,5	28,0	36,5	24	10
T15C1238	12	3/8	10,5	32,0	22,0	35,8	19	10
T15C1212	12	1/2	13,5	38,5	28,0	36,8	24	10

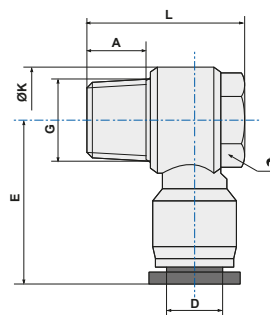

NOTA: articolo di importazione - NOTE: imported item

ART. T15FC

 Anello semplice girevole con asta femmina conico
Female complete single banjo tapered

CODICE	ØD	G/G1	L1	A1	B	ØK		
T15FC0418	4	1/8	23,5	7,5	29,0	14,4	14	50
T15FC0414	4	1/4	25,5	9,5	35,0	18,3	17	50
T15FC0618	6	1/8	24,0	7,5	29,0	14,4	14	50
T15FC0614	6	1/4	25,4	9,5	35,0	18,3	17	50
T15FC0818	8	1/8	26,5	7,5	29,0	14,4	14	50
T15FC0814	8	1/4	28,9	9,5	35,0	18,3	17	50
T15FC0838	8	3/8	30,0	10,5	40,0	22,0	21	25
T15FC1014	10	1/4	33,0	9,5	35,0	22,0	21	25
T15FC1038	10	3/8	33,5	10,5	40,0	28,0	24	25
T15FC1012	10	1/2	36,5	13,5	47,5	18,3	17	10
T15FC1238	12	3/8	35,5	10,5	40,0	22,0	21	10
T15FC1212	12	1/2	36,5	13,5	47,5	28,0	24	10

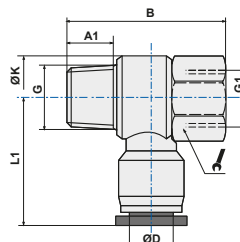
 NOTA: articolo di importazione
 NOTE: imported item

ART. T15B

 Anello due vie girevole con asta
Single branch universal male elbow

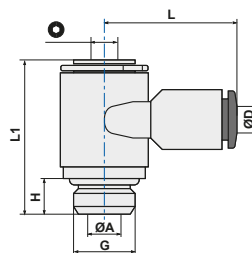
CODICE	ØD	G	ØA	H	L1	L		
T15B04M5	4	M5	2,0	4,0	17,8	19,5	2,5	50
T15B0618	6	1/8	5,5	5,5	24,5	24,3	3,0	50
T15B0814	8	1/4	7,8	6,5	28,0	26,5	4,0	50
T15B1038	10	3/8	10,0	7,5	32,5	29,9	5,0	25
T15B1212	12	1/2	12,0	9,0	38,8	34,9	8,0	10

ART. T16

 Anello doppio girevole con asta
Complete double banjo (rotating under pressure)

CODICE	ØD	G	ØA	H	L1	L		
T1604M5	4	M5	2,0	4,0	17,8	19,5	2,5	50
T160418	4	1/8	5,5	5,5	24,5	21,1	3,0	50
T160814	8	1/4	7,8	6,5	28,0	26,5	4,0	25
T160838	8	3/8	10,0	7,5	32,5	28,0	5,0	25
T161014	10	1/4	7,8	6,5	28,0	28,4	4,0	25
T161038	10	3/8	10,0	7,5	32,5	29,9	5,0	25
T161012	10	1/2	12,0	9,0	38,8	30,0	8,0	10
T161238	12	3/8	10,0	7,5	32,5	31,4	5,0	25
T161212	12	1/2	12,0	9,0	38,8	34,9	8,0	10

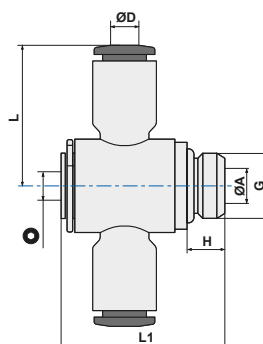

 Art. disponibile fino ad esaurimento scorte
 Item available while stocks last

ART. T18

Giunzione tripla intermedia
Triple branch union

CODICE	ØD	ØD1	J	B	Ød	F2		
T180604	6	4	22	58,0	3,2	36	25	
T180804	8	4	26	63,4	3,2	42	25	
T180806	8	6	26	63,4	3,2	42	25	
T181006	10	6	29	83,8	4,2	48	10	
T181008	10	8	29	83,6	4,2	48	10	

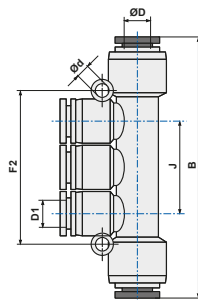
NOTA: articolo di importazione - NOTE: imported item



ART. T18G

Giunzione tripla filettata
Male triple branch

CODICE	ØD	D1	G	A	B	J		Ød	
T18G0418	4	4	1/8	5,5	68,0	26	14	3,2	25
T18G0414	4	4	1/4	7,5	70,0	26	17	3,2	25
T18G0438	4	4	3/8	7,5	70,0	26	20	3,2	10
T18G0618	6	6	1/8	5,5	68,0	26	14	3,2	25
T18G0614	6	6	1/4	7,5	70,0	26	17	3,2	25
T18G0638	6	6	3/8	7,5	70,5	26	20	3,2	10
T18G0612	6	6	1/2	9	73,0	26	24	3,2	10
T18G0818	8	8	1/8	5,5	87,0	29	14	3,2	10
T18G0814	8	8	1/4	7,5	89,0	29	17	3,2	10
T18G0838	8	8	3/8	7,5	89,5	29	20	3,2	10
T18G0812	8	8	1/2	9	92,5	29	24	3,2	10
T18G1018	10	10	1/8	5,5	95,5	37	14	4,2	10
T18G1014	10	10	1/4	7,5	98,0	37	17	4,2	10
T18G1038	10	10	3/8	7,5	98,5	37	20	4,2	10
T18G1012	10	10	1/2	9	101,5	37	24	4,2	10

NOTA: articolo di importazione - NOTE: imported item

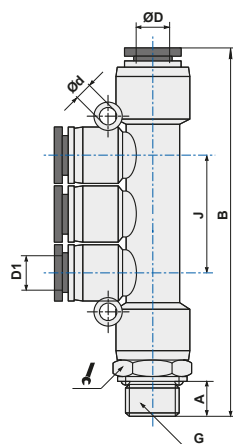

ART. T20

Raccordo a T centrale girevole
Swivel male stud T parallel

CODICE	ØD	G	ØB	H	L	L1		
T2004M3	4	M3	9,5	3,0	17,2	15,0	8	50
T2004M5	4	M5	9,5	4,0	17,2	17,0	8	50
T200418	4	1/8	9,5	5,5	17,2	18,5	13	50
T200414	4	1/4	9,5	7,5	17,2	20,4	16	50
T200438*	4	3/8	11,0	7,5	19,0	27,3	20	25
T2006M5	6	M5	9,5	4,0	20,8	17,0	8	50
T200618	6	1/8	11,5	5,5	20,8	18,5	13	50
T200614	6	1/4	11,5	7,5	20,8	20,4	16	50
T200638*	6	3/8	13,0	7,5	19,5	27,5	20	25
T200612*	6	1/2	13,0	9	19,5	30,0	24	10
T200818	8	1/8	13,5	5,5	23,0	20,0	13	50
T200814	8	1/4	13,5	6,5	23,0	20,4	16	50
T200838	8	3/8	13,5	7,5	23,0	24,8	18	25
T200812*	8	1/2	15,0	9	22,5	32,5	24	10
T201018*	10	1/8	19,0	5,5	28,5	32,3	17	25
T201014	10	1/4	17,0	7,5	26,4	23,2	16	25
T201038*	10	3/8	19,0	10,5	28,5	38,0	17	25
T201012*	10	1/2	17,0	9	26,4	31,1	21	10
T201218*	12	1/8	21,5	5,5	29,5	33,5	27	10
T201214*	12	1/4	21,5	7,5	29,5	38,5	21	10
T201238*	12	3/8	20,0	7,5	28,9	26,3	18	10
T201212*	12	20	20,0	9	28,9	29,3	21	10

* = di importazione - imported

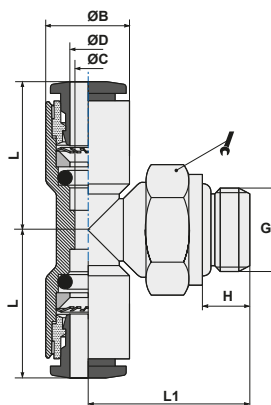

ART. T21

 Raccordo a T laterale girevole
Swivel male branch T parallel

CODICE	ØD	G	ØB	H	L	L1		
T2104M3	4	M3	9,5	3	12,2	15,0	8	50
T2104M5	4	M5	9,5	4	12,2	17,0	8	50
T210418	4	1/8	9,5	5,5	17,2	18,5	13	50
T210414	4	1/4	9,5	7,5	17,2	20,4	16	50
T210438*	4	3/8	11,0	7,5	19	27,3	20	25
T210618	6	1/8	11,5	5,5	20,8	18,5	13	50
T210614	6	1/4	11,5	7,5	20,8	20,4	16	50
T210638*	6	3/8	13,0	7,5	19,7	27,5	20	25
T210612*	6	1/2	13,0	9	19,7	30	24	10
T210818	8	1/8	13,5	5,5	23	20	13	50
T210814	8	1/4	13,5	7,5	23	20,4	16	50
T210838	8	3/8	13,5	9	23	24,8	18	25
T210812*	8	1/2	14,4	9	22,5	32,5	24	10
T211018*	10	1/8	19,0	5,5	27,8	32,5	17	25
T211014*	10	1/4	17,0	6,5	26,4	23,2	16	25
T211038*	10	3/8	19,0	7,5	28,5	38,5	17	25
T211012*	10	1/2	17,0	9	26,4	31,1	21	10
T211218*	12	1/8	21,0	5,5	29,5	33,5	21	25
T211214*	12	1/4	21,0	7,5	29,5	36	21	10
T211238*	12	3/8	20,0	7,5	28,9	26,3	18	10
T211212*	12	1/2	20,0	9	28,9	31,1	21	10

* = di importazione - imported

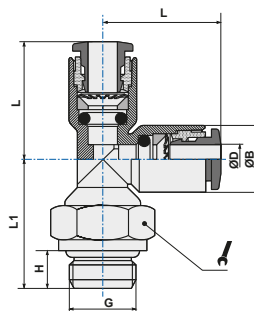
ART. T22

 Gomito girevole filetto cilindrico maschio con O-Ring
Swivel L male adaptor parallel

CODICE	ØD	G	ØB	H	L	L1		
T2204M3	4	M3	9,5	3	17,2	17	8	50
T2204M5	4	M5	9,5	4	17,2	17	8	100
T220418	4	1/8	9,5	5,5	17,2	18,5	13	100
T220414	4	1/4	9,5	6,5	17,2	20,4	16	100
T2206M5	6	M5	11,5	4	20,8	17	8	100
T220618	6	1/8	11,5	5,5	20,8	18,5	13	100
T220614	6	1/4	11,5	6,5	20,8	20,4	16	100
T220818	8	1/8	13,5	5,5	23	20	13	100
T220814	8	1/4	13,5	6,5	23	20,4	16	100
T220838	8	3/8	13,5	7,5	23	24,8	18	50
T221018*	10	1/8	19	5,5	27,8	26	14	50
T221014	10	1/4	17	6,5	26,4	23,2	16	50
T221038	10	3/8	17	7,5	26,4	24,8	18	50
T221012	10	1/2	17	9	26,4	31,1	21	25
T221214	12	1/4	20	6,5	28,9	24,2	16	25
T221238	12	3/8	20	7,5	28,9	26,3	18	25
T221212	12	1/2	20	9	28,9	31,1	21	25

* = di importazione - imported

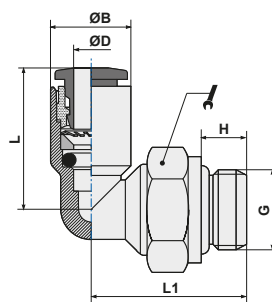

ART. T22C

Gomito girevole filetto conico
Swivel L male adaptor tapered

CODICE	ØD	G	ØB	H	L	L1		
T22C0418	4	1/8	11,5	7,5	17,2	20,5	13	100
T22C0414	4	1/4	11,5	9,5	19,0	20,0	14	100
T22C0438	4	3/8	11,5	10,5	19,0	21,0	17	25
T22C0618	6	1/8	13,5	7,5	19,2	21,5	13	100
T22C0614	6	1/4	13,5	9,5	19,2	21,0	14	100
T22C0638	6	3/8	13,5	10,5	19,2	22,0	17	25
T22C0612	6	1/2	13,5	13,5	19,2	25,5	21	10
T22C0818	8	1/8	15,0	7,5	22,5	22,2	13	100
T22C0814	8	1/4	15,0	9,5	22,5	21,7	14	100
T22C0838	8	3/8	15,0	10,5	23,0	22,7	17	50
T22C0812	8	1/2	15,0	13,5	22,5	26,2	21	10
T22C1018	10	1/8	19,0	7,5	27,8	26,9	13	50
T22C1014	10	1/4	19,0	9,5	27,8	28,4	14	50
T22C1038	10	3/8	19,0	10,5	27,8	24,7	17	50
T22C1012	10	1/2	19,0	13,5	27,8	28,2	21	25
T22C1218	12	1/8	21,5	7,5	29,5	28,2	15	25
T22C1214	12	1/4	21,5	9,5	29,5	29,7	15	25
T22C1238	12	3/8	21,5	10,5	29,5	26,0	21	50
T22C1212	12	1/2	21,5	13,5	29,5	29,5	21	25

NOTA: articolo di importazione - NOTE: imported item

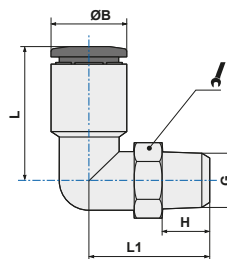

ART. T22F

Gomito girevole femmina
Female swivel L adaptor

CODICE	ØD	G	A	B	E		
T22F04M5	4	M5	5,5	20,5	19,0	10	50
T22F0418	4	1/8	8,5	24,0	19,0	14	50
T22F0414	4	1/4	11,0	27,0	19,0	17	50
T22F06M5	6	M5	6,0	20,7	19,2	12	50
T22F0618	6	1/8	8,5	24,2	19,2	14	50
T22F0614	6	1/4	11,0	27,2	19,2	17	50
T22F0638	6	3/8	12,0	28,7	19,2	21	25
T22F0818	8	1/8	8,0	27,0	23,0	14	50
T22F0814	8	1/4	11,0	30,5	23,0	17	50
T22F0838	8	3/8	12,0	32,0	23,0	21	25
T22F1014	10	1/4	11,0	34,3	28,2	17	25
T22F1038	10	3/8	12,0	35,8	28,2	21	25
T22F1012	10	1/2	14,0	38,8	28,2	24	10
T22F1214	12	1/4	11,0	37,0	29,5	21	25
T22F1238	12	3/8	12,0	38,0	29,5	21	25
T22F1212	12	1/2	14,0	40,5	29,5	24	10

NOTA: articolo di importazione - NOTE: imported item

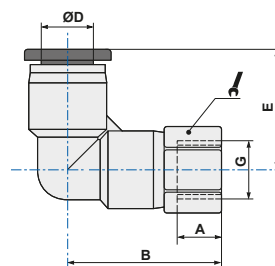

ART. T22L

 Gomito girevole cilindrico lungo
Swivel longer L male adaptor parallel

CODICE	ØD	G	ØB	H	L	L1		
T22L04M5*	4	M5	11,0	3,5	34,5	19,0	10	25
T22L0418	4	1/8	9,5	6,0	35,7	17,2	13	25
T22L06M5*	6	M5	13,0	3,5	36,4	19,2	12	25
T22L0618	6	1/8	11,5	6,0	35,7	20,8	13	25
T22L0818	8	1/8	13,5	6,0	38,0	23,0	13	25
T22L0814*	8	1/4	15,0	7,5	44,3	22,5	17	25

* = di importazione - imported

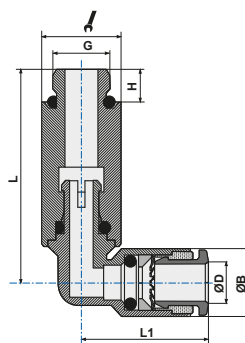
ART. T22LC

 Gomito girevole conico lungo
Swivel longer L male adaptor tapered

CODICE	ØD	G	A	B	ØC	E		
T22LC0418	4	1/8	7,5	37,0	11,0	19,0	10	25
T22LC0414	4	1/4	9,5	40,0	11,0	19,0	14	25
T22LC0618	6	1/8	7,5	39,7	13,0	19,2	12	25
T22LC0614	6	1/4	9,5	42,2	13,0	19,2	14	25
T22LC0638	6	3/8	10,5	43,7	13,0	19,2	17	25
T22LC0818	8	1/8	7,5	44,8	14,4	23,0	14	25
T22LC0814	8	1/4	9,5	46,8	14,4	23,0	17	25
T22LC0838	8	3/8	10,5	48,5	14,4	23,0	17	25
T22LC1018	10	1/8	7,5	54,3	18,5	28,2	17	25
T22LC1014	10	1/4	9,5	56,3	18,5	28,2	17	25
T22LC1038	10	3/8	10,5	57,3	18,5	28,2	17	25
T22LC1012	10	1/2	13,5	60,8	18,5	28,2	21	10
T22LC1214	12	1/4	9,5	61,5	21,0	29,5	21	10
T22LC1238	12	3/8	10,5	62,5	21,0	29,5	21	10
T22LC1212	12	1/2	13,5	65,5	21,0	29,5	21	10

NOTA: articolo di importazione - NOTE: imported item

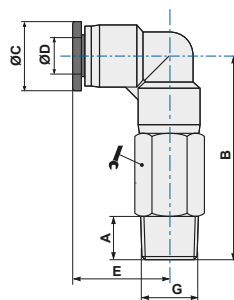
ART. T45

 Gomito girevole cilindrico a 45°
Swivel 45° L male adaptor parallel

CODICE	ØD	G	L1	L2	L3	L4	ØD1		
T4504M5	4	M5	3,5	22,5	19	39,5	11,3	10	1
T450418	4	G1/8	5,5	25,5	19	42,5	11,3	14	1
T450618	6	G1/8	5,5	25,5	19,2	43,5	13,3	14	1
T450614	6	G1/4	7,5	28	19,2	46	13,3	17	1
T450818	8	G1/8	5,5	29	22,5	49,5	14,8	14	1
T450814	8	G1/4	7,5	31,5	22,5	52	14,8	17	1
T451014	10	G1/4	7,5	36	27,8	62,5	18,7	17	1
T451038	10	G3/8	7,5	36	27,8	62,5	18,7	20	1

NOTA: articolo di importazione - NOTE: imported item

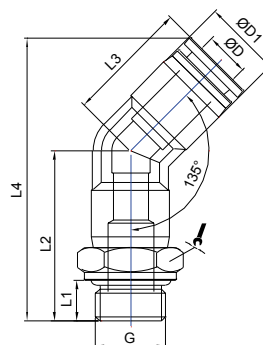

ART. T23

Y innestabile
Y connector

CODICE	ØD1	ØD2	ØE	ØB	A	L		
T230400	4	4	2,40	9,5	19	33,0		50
T230406	4	6	2,40	11,5	19	35,8		50
T230600	6	6	2,60	11,5	23	38,6		50
T230608	6	8	3,20	13,5	23	39,8		50
T230800	8	8	2,75	16,5	27	42,5		50
T230810	8	10	3,20	17,0	27	44,4		25
T231000	10	10	4,30	20,0	34	50,8		25
T231012*	10	12	4,30	20,0	34	50,8		10
T231200	12	12	4,20	20,0	40	53,2		10

* = di importazione - imported

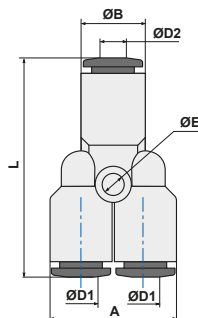

ART. T23L0

Y innestabile
Y connector

CODICE	ØD1	ØD2	ØB	A	ØE	L	L1	
T2304L0	4	4	9,5	19	2,40	50,0	16,7	50
T2306L0	6	6	11,5	23	2,60	58,1	19,5	50
T2308L0	8	8	13,5	27	2,75	63,5	21,0	50
T2310L0	10	10	17,0	34	4,30	74,8	24,0	25
T2312L0	12	12	20,0	40	4,20	78,2	25,0	10

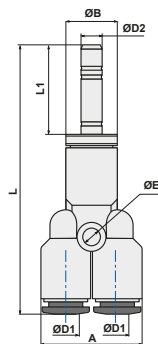

ART. T23G

Y innestabile filetto cilindrico con O-Ring
Y connector with swivel parallel male adapter

CODICE	ØD	G	ØA	ØB	H	A	L		
T23G04M5*	4	M5	2,0	9,5	4,0	19,0	39,1	10	50
T23G0418	4	1/8	3,0	9,5	5,5	19,0	20,5	13	50
T23G0414	4	1/4	3,0	11,0	7,5	22,0	45,5	17	50
T23G0438*	4	3/8	3,0	11,0	7,5	22,0	46,0	20	25
T23G0618	6	1/8	5,0	11,5	5,5	23,0	34,8	13	50
T23G0614	6	1/4	5,0	11,5	6,5	23,0	36,4	16	50
T23G0638*	6	3/8	5,0	13,0	7,5	26,0	47,2	20	25
T23G0818	8	1/8	7,0	13,5	5,5	27,0	37,5	13	50
T23G0814	8	1/4	7,0	13,5	6,5	27,0	38,6	16	50
T23G0838*	8	3/8	6,2	14,4	7,5	29,4	50,5	20	25
T23G1014*	10	1/4	8,2	18,4	7,5	36,4	58,9	17	25
T23G1038*	10	3/8	8,2	18,4	7,5	36,4	58,9	20	25
T23G1012*	10	1/2	8,2	18,4	10	36,4	62,4	24	10
T23G1214*	12	1/4	9,5	21,0	7,5	42,0	62,3	21	10
T23G1238*	12	3/8	9,5	21,0	7,5	42,0	62,3	21	10
T23G1212*	12	1/2	9,5	21,0	10	42,0	65,3	24	10

* = di importazione - imported

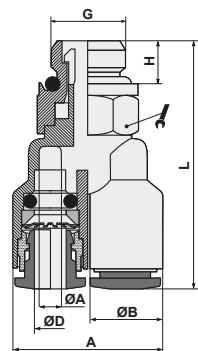

ART. T24

 Y doppio innestabile
Double Y connector

CODICE	ØD1	ØD2	ØE	ØB	A max	L		
T240400	4	4	3,2	9,5	20,2	34,5		25
T240406	4	6	3,2	13,0	20,8	35,5		25
T240408*	4	8	3,2	14,5	22,2	38,5		25
T240600	6	6	3,2	11,5	23,9	39,6		25
T240608*	6	8	3,2	13,5	26,15	41,8		25
T240800*	8	8	3,5	15,0	28,0	42,0		25
T240810	8	10	3,2	17,0	28,0	46,5		25

* = di importazione - imported

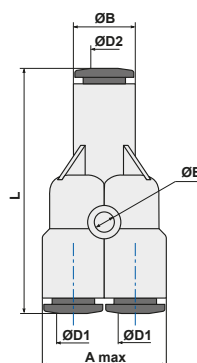
ART. T24LO

 Y doppio innestabile
Double Y connector

CODICE	ØD1	ØD2	ØE	ØB	A	L	L1	
T2404LO	4	4	2,40	9,5	19	51,2	16,7	25
T2406LO	6	6	2,60	11,5	23	59,1	19,5	25
T2408LO	8	8	2,75	13,5	27	67,5	21,0	25

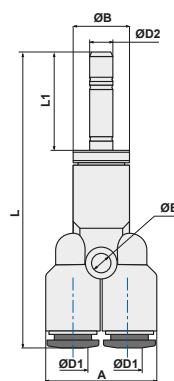
ART. T33

 Doppio anello semplice girevole con asta
Swivel double banjo stem

CODICE	ØD	G	ØA	H	L1	L	⊘	⌘	
T3304M5	4	M5	2,0	4,0	28,0	19,5	2,5	14	25
T330418	4	1/8	5,5	5,5	43,3	21,1	3	14	25
T330618	6	1/8	5,5	5,5	43,3	24,3	3	14	25
T330614	6	1/4	7,8	6,5	50,0	25,5	4	18	25
T330818	8	1/8	5,5	5,5	43,3	24,8	3	14	25
T330814	8	1/4	7,8	6,5	50,0	26,5	4	18	25
T331014	10	1/4	7,8	6,5	50,0	28,4	4	18	25

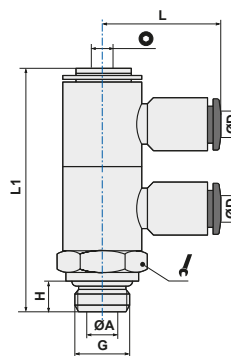
ART. T33B

 Doppio anello due vie girevole con asta
Double branch universal male L

CODICE	ØD	G	ØA	H	L1	L	⊘	⌘	
T33B04M5	4	M5	2,0	4,0	28,0	19,5	2,5	14	10
T33B0618	6	1/8	5,5	5,5	43,3	24,3	3	14	10
T33B0814	8	1/4	7,8	6,5	50,0	26,5	4	18	10

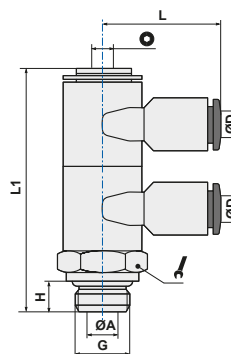

ART. T34

Triplo anello semplice girevole con asta
Swivel triple banjo stem

CODICE	ØD	G	ØA	H	L1	L	Ø	Icona	Icona
T340418	4	1/8	5,5	5,5	58,4	21,1	3	14	10
T340618	6	1/8	5,5	5,5	58,4	24,3	3	14	10
T340818	8	1/8	5,5	5,5	58,4	24,8	3	14	10
T340614	6	1/4	7,8	6,5	67	25,5	4	18	10
T340814	8	1/4	7,8	6,5	67	26,5	4	18	10
T341014	10	1/4	7,8	6,5	67	28,4	4	18	10

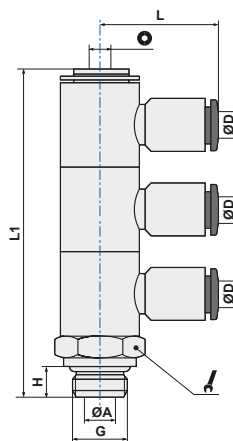

ART. T34B

Triplo anello due vie girevole con asta
Triple branch universal male L

CODICE	ØD	G	ØA	H	L1	L	Ø	Icona	Icona
T34B0618	6	1/8	5,5	5,5	58,4	24,3	3	14	10
T34B0814	8	1/4	7,8	6,5	67	26,5	4	18	10

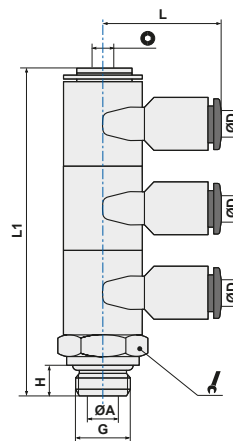

ART. T90

Tappo femmina
Tube Blanking Cap

CODICE	ØD	ØD1	L				Icona
T900400	4	11,5	17,5				100
T900600	6	13,5	17,7				100
T900800	8	15	21,3				100
T901000	10	19	25				50
T901200	12	21,5	26				50

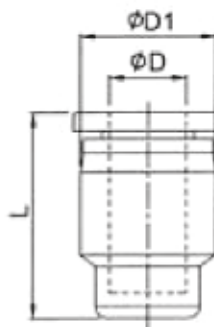

Adattabile a tutti i raccordi della serie Tecno-RAP
Suitable for all Tecno-RAP fitting series

Di importazione
Import

1 ANELLO DI SOSTEGNO
LOCK RING

2 PINZA DI AGGRAFFAGGIO
CRIMPING GRIPPER

3 DISTANZIALE DI FERMO
LOCK RING

4 ANELLO SPINGITORE
THRUST SLEEVE

5 O-RING DI TENUTA
O-RING SEAL

6 BASE GIREVOLE
SWIVEL BASE

7 CORPO DEL RACCORDO
FITTING BODY

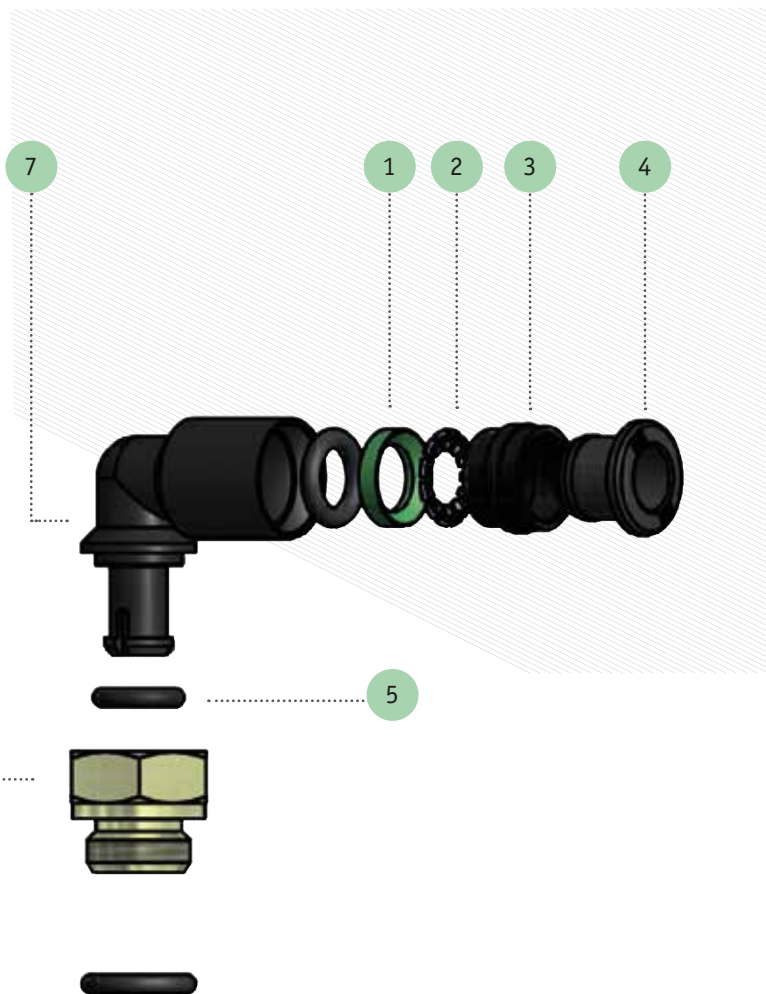

MAIN SERIES



TBV SERIES
ON DEMAND



TBS SERIES
ON DEMAND



TBA SERIES
ON DEMAND

ART. TB01

Diritto filetto cilindrico maschio con O-Ring
Straight male adaptor (parallel)

CODICE	ØD	G	ØC	ØB	H	L			
TB010418	4	1/8	2,5	14,0	5,5	19,0	10	2,5	50
TB010414	4	1/4	2,5	17,5	6,5	20,8	10	2,5	50
TB010618	6	1/8	4,0	14,0	5,5	24,5	12	4,0	50
TB010614	6	1/4	4,0	17,5	6,5	26,0	12	4,0	50
TB010818	8	1/8	5,0	14,0	5,5	25,7	14	5,0	50
TB010814	8	1/4	6,0	17,5	6,5	27,2	14	6,0	50
TB011014	10	1/4	7,0	17,5	6,5	28,7	18	7,0	50

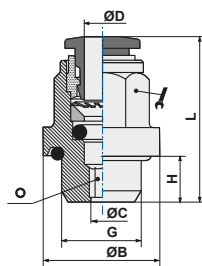

ART. TB03

Diritto innestabile
Straight connector

CODICE	ØD	ØD1	ØC	ØB	ØB1	L	
TB030400	4	4	3	9,5	9,5	32,0	50
TB030406	4	6	3	9,5	11,5	32,5	50
TB030600	6	6	5	11,5	11,5	35,6	50
TB030608	6	8	5	11,5	13,5	36,0	50
TB030800	8	8	7	13,5	13,5	38,0	25
TB030810	8	10	7	13,5	17,0	32,5	50
TB031000	10	10	9	17,0	17,0	42,3	50
TB031012	10	12	9	17,0	20,0	44,0	50
TB031200	12	12	10	20,0	20,0	46,2	25

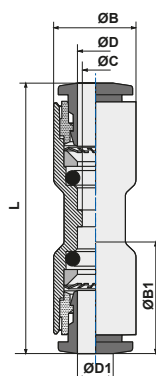

ART. TB04

Gomito innestabile
Elbow connector

CODICE	ØD	ØC	ØB	L	ØE	
TB040400	4	3	9,5	17,2	3,2	50
TB040600	6	5	11,5	20,8	3,2	50
TB040800	8	7	13,5	23,0	3,2	50
TB041000	10	9	17,0	26,4	4,3	50
TB041200	12	10	20,0	28,9	4,2	25

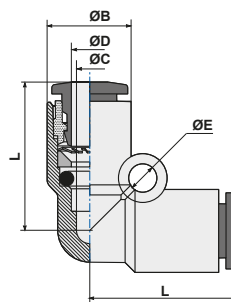

ART. TB04LO

Gomito innestabile con codolo
Plug-in elbow connector

CODICE	ØD	ØC	ØB	L	L1	ØA	L2	
TB0404LO	4	3	9,5	17,2	20,75	4	16,7	50
TB0406LO	6	5	11,5	20,8	24,25	6	19,5	50
TB0408LO	8	7	13,5	23,0	27,25	8	21,0	50
TB0410LO	10	9	17,0	26,4	31,80	10	24,0	50
TB0412LO	12	10	20,0	28,9	36,00	12	25,0	25

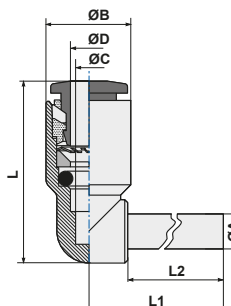

ART. TB05

 T innestabile
T connector

CODICE	ØD	ØD1	ØC	ØB	L		
TB050400	4	4	3,0	9,5	17,2		50
TB050604*	6	4	5,3	13,0	19,2		50
TB050600	6	6	5,0	11,5	20,8		50
TB050806*	8	6	7,1	14,4	22,7		25
TB050800	8	8	7,0	13,5	23,0		50
TB051008*	10	8	9,3	18,4	27,9		25
TB051000	10	10	9,0	17,0	26,4		25
TB051210*	12	10	10,0	21,0	29,9		10
TB051200	12	12	10,0	20,0	28,9		10

* = di importazione - imported

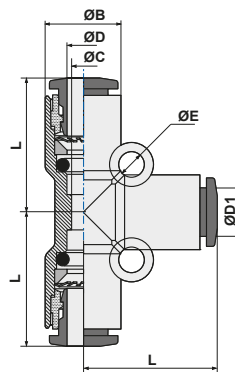
ART. TB05L0

 T Innestabile con codolo centrale
Plug-in T connector (center)

CODICE	ØD	ØC	ØB	L	L1	ØA	L2	
TB0504L0	4	3	9,5	17,2	20,75	4	16,7	50
TB0506L0	6	5	11,5	20,8	24,25	6	19,5	50
TB0508L0	8	7	13,5	23,0	27,25	8	21,0	50
TB0510L0	10	9	17,0	26,4	31,80	10	24,0	25
TB0512L0	12	10	20,0	28,9	36,00	12	25,0	10

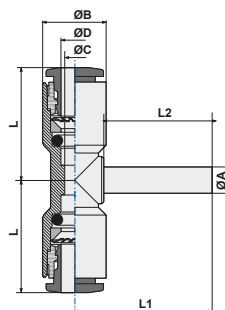
 Art. disponibile fino ad esaurimento scorte
 Item available while stocks last

ART. TB05V0

 T Innestabile con codolo laterale
Plug-in T connector (lateral)

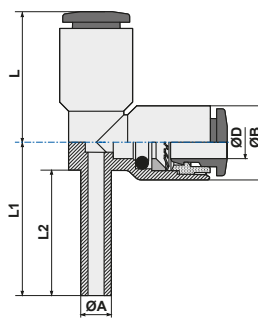
CODICE	ØD	ØB	L	L1	ØA	L2	
TB0506V0	6	11,5	20,8	24,25	6	19,5	50
TB0508V0	8	13,5	23,0	27,25	8	21,0	50
TB0510V0	10	17,0	26,4	31,80	10	24,0	25
TB0512V0	12	20,0	28,9	36,00	12	25,0	10

 Art. disponibile fino ad esaurimento scorte
 Item available while stocks last

ART. TB08

 Riduzione
Reducer

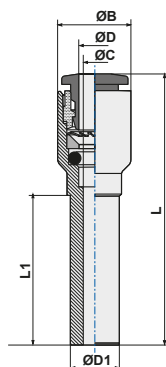
CODICE	ØD1	ØD	ØC	ØB	L	L1	
TB080604	6	4	3	9,5	35,5	19,5	50
TB080804	8	4	3	9,5	37,0	21,0	50
TB081004	10	4	3	9,5	40,0	24,0	25
TB081204	12	4	3	9,5	41,0	25,0	25
TB080806	8	6	5	11,5	39,05	23,0	50
TB081006	10	6	5	11,5	42,05	24,0	25
TB081206	12	6	5	11,5	43,05	25,0	25
TB081008	10	8	7	13,5	43,0	26,25	25
TB081208	12	8	7	13,5	44,0	25,0	25
TB081210	12	10	9	17,0	46,15	27,55	25



ART. TB10

Passaparete
Bulkhead connector

CODICE	ØD	ØB	L	M	Imax		
TB100400	4	9,5	32,0	11x1	8	14	50
TB100600	6	11,5	36,1	14x1	8	17	50
TB100800	8	13,5	38,0	16x1	10	18	50
TB101000	10	17,5	42,3	20x1	12	24	25
TB101200	12	20,0	46,2	22x1	17	26	25

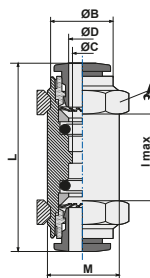

ART. TB10L

Passaparete a "L"
L bulkhead

CODICE	ØD	M	B	E	H	L max	
TB10L0400	4	12x1	28,5	19,0	14	6	25
TB10L0600	6	14x1	32,1	19,2	17	7	25
TB10L0800	8	16x1	39,4	23,0	19	7,5	25
TB10L1000	10	20x1	44,8	28,2	24	9,5	25
TB10L1200	12	22x1	46,6	29,5	27	10	50

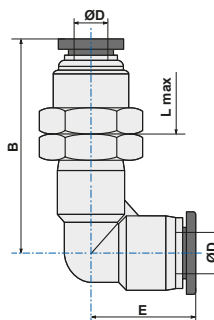

NOTA: articolo di importazione - NOTE: imported item

ART. TB11

Croce intermedio
Cross connector

CODICE	ØD	ØB	ØA	C	
TB110400	4	9,5	17,2	3	25
TB110600	6	11,5	20,8	3	25
TB110800	8	13,5	23,0	3	25
TB111000*	10	17,0	6,5	3	10
TB111200*	12	20,0	28,8	3	10

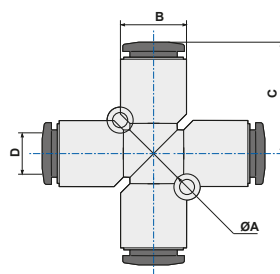

* = di importazione - imported

ART. TB13

Anello semplice
Single banjo body

CODICE	ØD	G*	ØC	ØB	H	L	ØF	
TB1304M5	4	M5	3	9,5	10	19,5	8,0	50
TB130418	4	1/8	3	9,5	15	21,1	14,0	50
TB130618	6	1/8	5	11,5	15	24,3	14,0	50
TB130614	6	1/4	5	11,5	17	25,5	18,0	50
TB130818	8	1/8	7	13,5	15	24,8	14,0	50
TB130814	8	1/4	7	13,5	17	26,5	18,0	50
TB130838	8	3/8	7	13,5	20	28,0	21,3	50
TB131014	10	1/4	9	17,0	17	28,4	18,0	50
TB131038	10	3/8	9	17,0	20	29,9	21,3	25
TB131012	10	1/2	9	17,0	24	30,0	26,0	25
TB131238	12	3/8	10	20,0	20	31,4	21,3	25
TB131212	12	1/2	10	20,0	24	34,9	26,0	25
TB13R04M5	4	M5	3	9,5	10	19,5	8	50
TB13R06M5	6	M5	5	11,5	10	23	8	50

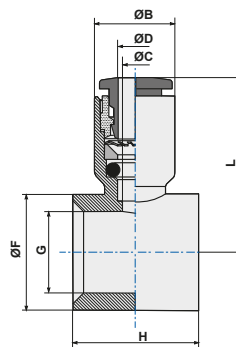

(*) G = filetto vite/asta
(*) G = steam thread

Vedi capitolo Astine pag. 39
See page 39 of Stems section

ART. TB13B

 Anello semplice due vie
Single branch body

CODICE	ØD	G*		H	L	L2		
TB13B04M5	4	M5		10	19,5	19		50
TB13B0618	6	1/8		15	24,3	23		50
TB13B0814	8	1/4		17	26,5	27		50
TB13B1038	10	3/8		20	29,9	34		25
TB13B1212	12	1/2		24	34,9	40		10

(*) G = filetto vite/asta

(*) G = steam thread

H = altezza sede asta - H = stem site lenght

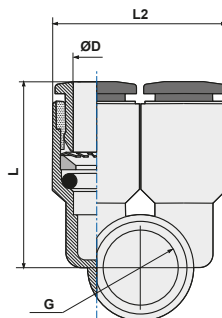
 Vedi capitolo Astine pag. 39
 See page 39 of Stems section

ART. TB14

 Anello doppio
Double banjo body

CODICE	ØD	G*	ØC	ØB	H	ØF	L	
TB1404M5	4	M5	3	9,5	10	8,0	19,5	50
TB140418	4	1/8	3	9,5	15	14,0	21,1	50
TB140618	6	1/8	5	11,5	15	14,0	24,3	50
TB140614	6	1/4	5	11,5	17	18,0	25,5	50
TB140818	8	1/8	7	13,5	15	14,0	24,8	50
TB140814	8	1/4	7	13,5	17	18,0	26,5	50
TB140838	8	3/8	7	13,5	20	21,3	28,0	25
TB141014	10	1/4	9	17,0	17	18,0	28,4	50
TB141038	10	3/8	9	17,0	20	21,3	29,9	25
TB141012	10	1/2	9	17,0	24	26,0	30,0	10
TB141238	12	3/8	10	20,0	20	21,3	31,4	25
TB141212	12	1/2	10	20,0	24	26,0	34,9	10

(*) G = filetto vite/asta

(*) G = steam thread

 Art. disponibile fino ad esaurimento scorte
 Item available while stocks last

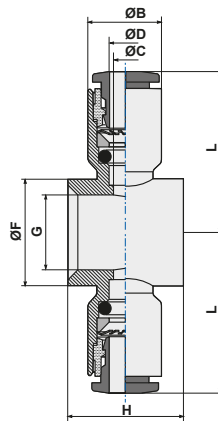
 Vedi capitolo Astine pag. 39
 See page 39 of Stems section

ART. TB15

 Anello semplice girevole con asta
Complete single banjo (rotating under pressure)

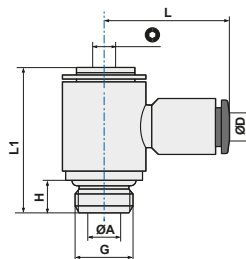
CODICE	ØD	G	ØA	H	L1	L	⊙	
TB1504M5	4	M5	2,0	4,0	17,8	19,5	2,5	50
TB1504M6	4	M6	2,0	5,0	18,9	19,5	2,5	50
TB150418	4	1/8	5,5	5,5	24,5	21,1	3,0	50
TB150618	6	1/8	5,5	5,5	24,5	24,3	3,0	50
TB150614	6	1/4	7,8	6,5	28,0	25,5	4,0	50
TB150818	8	1/8	5,5	5,5	24,5	24,8	3,0	50
TB150814	8	1/4	7,8	6,5	28,0	26,5	4,0	50
TB150838	8	3/8	10,0	7,5	32,5	28,0	5,0	25
TB151014	10	1/4	7,8	6,5	28,0	28,4	4,0	25
TB151038	10	3/8	10,0	7,5	32,5	29,9	5,0	25
TB151012	10	1/2	12,0	9,0	38,8	30,0	8,0	10
TB151238	12	3/8	10,0	7,5	32,5	31,4	5,0	10
TB151212	12	1/2	12,0	9,0	38,8	34,9	8,0	10



ART. TB15C

Anello semplice girevole con asta conico
Complete single banjo tapered

CODICE	ØD	G	A	L	ØK	E		
TB15C0418	4	1/8	7,5	23,0	14,4	23,5	12	50
TB15C0618	6	1/8	7,5	23,0	14,4	24,0	12	50
TB15C0614	6	1/4	9,5	26,5	18,3	25,4	14	50
TB15C0638	6	3/8	10,5	32,0	22,0	29,5	19	25
TB15C0818	8	1/8	7,5	23,0	14,4	28,9	14	50
TB15C0814	8	1/4	9,5	26,5	18,3	29,1	14	50
TB15C0838	8	3/8	10,5	32,0	22,0	30,0	19	25
TB15C1014	10	1/4	9,5	26,5	18,3	33,0	14	25
TB15C1038	10	3/8	10,5	32,0	22,0	33,5	19	25
TB15C1012	10	1/2	13,5	38,5	28,0	36,5	24	10
TB15C1238	12	3/8	10,5	32,0	22,0	35,8	19	10
TB15C1212	12	1/2	13,5	38,5	28,0	36,8	24	10

NOTA: articolo di importazione - NOTE: imported item

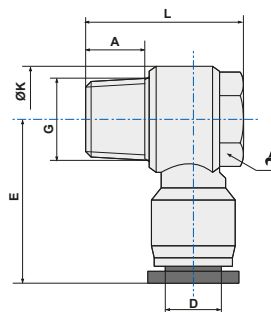

ART. TB15FC

Anello semplice girevole con asta femmina conico
Female complete single banjo tapered

CODICE	ØD	G/G1	L1	A1	B	ØK		
TB15FC0418	4	1/8	23,5	7,5	29,0	14,4	14	50
TB15FC0414	4	1/4	25,5	9,5	35,0	18,3	17	50
TB15FC0618	6	1/8	24,0	7,5	29,0	14,4	14	50
TB15FC0614	6	1/4	25,4	9,5	35,0	18,3	17	50
TB15FC0818	8	1/8	26,5	7,5	29,0	14,4	14	50
TB15FC0814	8	1/4	28,9	9,5	35,0	18,3	17	50
TB15FC0838	8	3/8	30,0	10,5	40,0	22,0	21	25
TB15FC1014	10	1/4	33,0	9,5	35,0	22,0	21	25
TB15FC1038	10	3/8	33,5	10,5	40,0	28,0	24	25
TB15FC1012	10	1/2	36,5	13,5	47,5	18,3	17	10
TB15FC1238	12	3/8	35,5	10,5	40,0	22,0	21	10
TB15FC1212	12	1/2	36,5	13,5	47,5	28,0	24	10

NOTA: articolo di importazione
NOTE: imported item

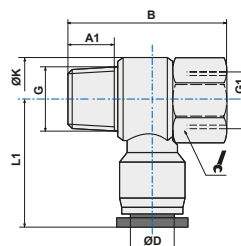

ART. TB15B

Anello due vie girevole con asta
Single branch universal male L

CODICE	ØD	G	ØA	H	L1	L	Ø	
TB15B04M5	4	M5	2,0	4,0	17,8	19,5	2,5	50
TB15B0618	6	1/8	5,5	5,5	24,5	24,3	3,0	50
TB15B0814	8	1/4	7,8	6,5	28,0	26,5	4,0	50
TB15B1038	10	3/8	10,0	7,5	32,5	29,9	5,0	25
TB15B1212	12	1/2	12,0	9,0	38,8	34,9	8,0	10

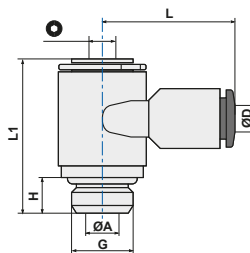

ART. TB16

 Anello doppio girevole con asta
Complete double banjo (rotating under pressure)

CODICE	ØD	G	ØA	H	L1	L	Ø	
TB1604M5	4	M5	2,0	4,0	17,8	19,5	2,5	50
TB160418	4	1/8	5,5	5,5	24,5	21,1	3,0	50
TB160618	6	1/8	5,5	5,5	24,5	24,3	3,0	50
TB160614	6	1/4	7,8	6,5	28,0	25,5	4,0	50
TB160818	8	1/8	5,5	5,5	24,5	24,8	3,0	50
TB160814	8	1/4	7,8	6,5	28,0	26,5	4,0	25
TB160838	8	3/8	10,0	7,5	32,5	28,0	5,0	25
TB161014	10	1/4	7,8	6,5	28,0	28,4	4,0	25
TB161038	10	3/8	10,0	7,5	32,5	29,9	5,0	25
TB161012	10	1/2	12,0	9,0	38,8	30,0	8,0	10
TB161238	12	3/8	10,0	7,5	32,5	31,4	5,0	25
TB161212	12	1/2	12,0	9,0	38,8	34,9	8,0	10

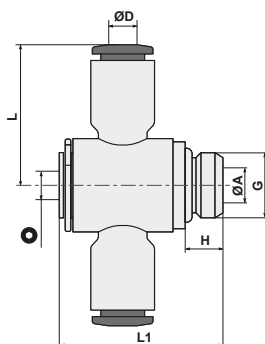
 Art. disponibile fino ad esaurimento scorte
 Item available while stocks last

ART. TB18

 Giunzione tripla intermedia
Triple branch union

CODICE	ØD	ØD1	J	B	Ød	F2	
TB180604	6	4	22	58,0	3,2	36	25
TB180804	8	4	26	63,4	3,2	42	25
TB180806	8	6	26	63,4	3,2	42	25
TB181006	10	6	29	83,8	4,2	48	10
TB181008	10	8	29	83,6	4,2	48	10

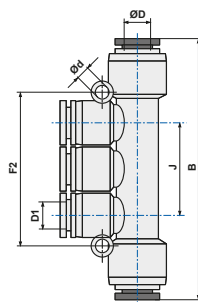
NOTA: articolo di importazione - NOTE: imported item

ART. TB18G

 Giunzione tripla filettata
Male triple branch

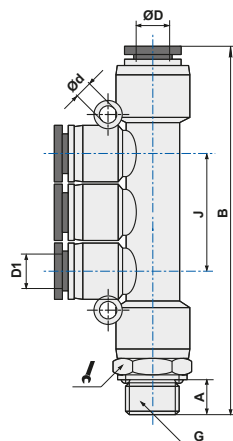

CODICE	ØD	D1	G	A	B	J		Ød	
TB18G0418	4	4	1/8	5,5	68,0	26	14	3,2	25
TB18G0414	4	4	1/4	7,5	70,0	26	17	3,2	25
TB18G0438	4	4	3/8	7,5	70,0	26	20	3,2	10
TB18G0618	6	6	1/8	5,5	68,0	26	14	3,2	25
TB18G0614	6	6	1/4	7,5	70,0	26	17	3,2	25
TB18G0638	6	6	3/8	7,5	70,5	26	20	3,2	10
TB18G0612	6	6	1/2	10	73,0	26	24	3,2	10
TB18G0818	8	8	1/8	5,5	87,0	29	14	3,2	10
TB18G0814	8	8	1/4	7,5	89,0	29	17	3,2	10
TB18G0838	8	8	3/8	7,5	89,5	29	20	3,2	10
TB18G0812	8	8	1/2	10	92,5	29	24	3,2	10
TB18G1018	10	10	1/8	5,5	95,5	37	14	4,2	10
TB18G1014	10	10	1/4	7,5	98,0	37	17	4,2	10
TB18G1038	10	10	3/8	7,5	98,5	37	20	4,2	10
TB18G1012	10	10	1/2	10	101,5	37	24	4,2	10

NOTA: articolo di importazione - NOTE: imported item



ART. TB20

Raccordo a T laterale girevole
Swivel male stud T parallel

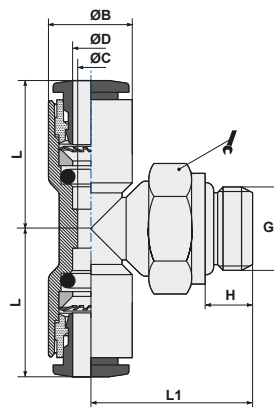

CODICE	ØD	G	ØB	H	L	L1		
TB2004M3	4	M3	9,5	3,0	17,2	15,0	8	50
TB2004M5	4	M5	9,5	4,0	17,2	17,0	8	50
TB200418	4	1/8	9,5	5,5	17,2	18,5	13	50
TB200414	4	1/4	9,5	7,5	17,2	20,4	16	50
TB200438*	4	3/8	11,0	7,5	19,0	27,3	20	25
TB2006M5	6	M5	9,5	4,0	20,8	17,0	8	50
TB200618	6	1/8	11,5	5,5	20,8	18,5	13	50
TB200614	6	1/4	11,5	7,5	20,8	20,4	16	50
TB200638*	6	3/8	13,0	7,5	19,5	27,5	20	25
TB200612*	6	1/2	13,0	10	19,5	30,0	24	10
TB200818	8	1/8	13,5	5,5	23,0	20,0	13	50
TB200814	8	1/4	13,5	6,5	23,0	20,4	16	50
TB200838	8	3/8	13,5	7,5	23,0	24,8	18	25
TB200812*	8	1/2	15,0	10	22,5	32,5	24	10
TB201018*	10	1/8	19,0	5,5	28,5	32,3	17	25
TB201014	10	1/4	17,0	7,5	26,4	23,2	16	25
TB201038*	10	3/8	19,0	10,5	28,5	38,0	17	25
TB201012*	10	1/2	17,0	9	26,4	31,1	21	10
TB201218*	12	1/8	21,5	5,5	29,5	33,5	27	10
TB201214*	12	1/4	21,5	7,5	29,5	38,5	21	10
TB201238*	12	3/8	20,0	7,5	28,9	26,3	18	10
TB201212*	12	20	20,0	11	28,9	29,3	21	10

* = di importazione - imported



ART. TB21

Raccordo a T laterale girevole
Swivel male branch T parallel

CODICE	ØD	G	ØB	H	L	L1		
TB2104M3	4	M3	9,5	3	12,2	15,0	8	50
TB2104M5	4	M5	9,5	4	12,2	17,0	8	50
TB210418	4	1/8	9,5	5,5	17,2	18,5	13	50
TB210414	4	1/4	9,5	7,5	17,2	20,4	16	50
TB210438*	4	3/8	11,0	7,5	19	27,3	20	25
TB2106M5	6	M5	9,5	4	20,8	17	8	50
TB210618	6	1/8	11,5	5,5	20,8	18,5	13	50
TB210614	6	1/4	11,5	7,5	20,8	20,4	16	50
TB210638*	6	3/8	13,0	7,5	19,7	27,5	20	25
TB210612*	6	1/2	13,0	10	19,7	30	24	10
TB210818	8	1/8	13,5	5,5	23	20	13	50
TB210814	8	1/4	13,5	7,5	23	20,4	16	50
TB210838	8	3/8	13,5	9	23	24,8	18	25
TB210812*	8	1/2	14,4	9	22,5	32,5	24	10
TB211018*	10	1/8	19,0	5,5	27,8	32,5	17	25
TB211014*	10	1/4	17,0	6,5	26,4	23,2	16	25
TB211038*	10	3/8	19,0	7,5	28,5	38,5	17	25
TB211012*	10	1/2	17,0	10	26,4	31,1	21	10
TB211218*	12	1/8	21,0	5,5	29,5	33,5	21	25
TB211214*	12	1/4	21,0	7,5	29,5	36	21	10
TB211238*	12	3/8	20,0	7,5	28,9	26,3	18	10
TB211212*	12	1/2	20,0	9	28,9	31,1	21	10

* = di importazione - imported

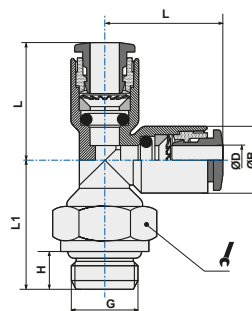

ART. TB22

 Gomito girevole filetto cilindrico maschio con O-Ring
Swivel L male adaptor parallel

CODICE	ØD	G	ØB	H	L	L1		
TB2204M3	4	M3	9,5	4	17,2	17	8	50
TB2204M5	4	M5	9,5	4	17,2	17	8	100
TB220418	4	1/8	9,5	5,5	17,2	18,5	13	100
TB220414	4	1/4	9,5	6,5	17,2	20,4	16	100
TB2206M5	6	M5	11,5	4	20,8	17	8	100
TB220618	6	1/8	11,5	5,5	20,8	18,5	13	100
TB220614	6	1/4	11,5	6,5	20,8	20,4	16	100
TB220818	8	1/8	13,5	5,5	23	20	13	100
TB220814	8	1/4	13,5	6,5	23	20,4	16	100
TB220838	8	3/8	13,5	7,5	23	24,8	18	50
TB221018*	10	1/8	19	5,5	27,8	26	14	50
TB221014	10	1/4	17	6,5	26,4	23,2	16	50
TB221038	10	3/8	17	7,5	26,4	24,8	18	50
TB221012	10	1/2	17	9	26,4	31,1	21	25
TB221214	12	1/4	20	6,5	28,9	24,2	16	50
TB221238	12	3/8	20	7,5	28,9	26,3	18	50
TB221212	12	1/2	20	9	28,9	31,1	21	25

* = di importazione - imported

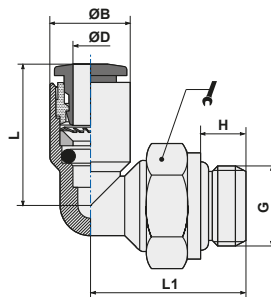
ART. TB22C

 Gomito girevole filetto conico
Swivel L male adaptor tapered

CODICE	ØD	G	ØB	H	L	L1		
TB22C0418	4	1/8	11,5	7,5	17,2	20,5	10	100
TB22C0414	4	1/4	11,5	9,5	19,0	20,0	14	100
TB22C0438	4	3/8	11,5	10,5	19,0	21,0	17	25
TB22C0618	6	1/8	13,5	7,5	19,2	21,5	10	100
TB22C0614	6	1/4	13,5	9,5	19,2	21,0	14	100
TB22C0638	6	3/8	13,5	10,5	19,2	22,0	17	25
TB22C0612	6	1/2	13,5	13,5	19,2	25,5	21	10
TB22C0818	8	1/8	15,0	7,5	22,5	22,2	12	100
TB22C0814	8	1/4	15,0	9,5	22,5	21,7	14	100
TB22C0838	8	3/8	15,0	10,5	23,0	22,7	17	50
TB22C0812	8	1/2	15,0	13,5	22,5	26,2	21	10
TB22C1018	10	1/8	19,0	7,5	27,8	26,9	14	50
TB22C1014	10	1/4	19,0	9,5	27,8	28,4	14	50
TB22C1038	10	3/8	19,0	10,5	27,8	24,7	17	50
TB22C1012	10	1/2	19,0	13,5	27,8	28,2	21	25
TB22C1218	12	1/8	21,5	7,5	29,5	28,2	15	25
TB22C1214	12	1/4	21,5	9,5	29,5	29,7	15	25
TB22C1238	12	3/8	21,5	10,5	29,5	26,0	21	50
TB22C1212	12	1/2	21,5	13,5	29,5	29,5	21	25

NOTA: articolo di importazione - NOTE: imported item

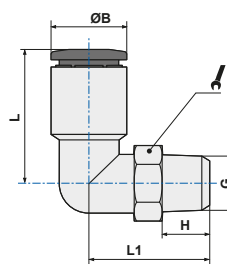

ART. TB22F

Gomito girevole femmina
Female swivel L adaptor

CODICE	ØD	G	A	B	E			
TB22F04M5	4	M5	5,5	20,5	19,0		10	50
TB22F0418	4	1/8	8,5	24,0	19,0		14	50
TB22F0414	4	1/4	11,0	27,0	19,0		17	50
TB22F06M5	6	M5	6,0	20,7	19,2		12	50
TB22F0618	6	1/8	8,5	24,2	19,2		14	50
TB22F0614	6	1/4	11,0	27,2	19,2		17	50
TB22F0638	6	3/8	12,0	28,7	19,2		21	25
TB22F0818	8	1/8	8,0	27,0	23,0		14	50
TB22F0814	8	1/4	11,0	30,5	23,0		17	50
TB22F0838	8	3/8	12,0	32,0	23,0		21	25
TB22F1014	10	1/4	11,0	34,3	28,2		17	25
TB22F1038	10	3/8	12,0	35,8	28,2		21	25
TB22F1012	10	1/2	14,0	38,8	28,2		24	10
TB22F1214	12	1/4	11,0	37,0	29,5		21	25
TB22F1238	12	3/8	12,0	38,0	29,5		21	25
TB22F1212	12	1/2	14,0	40,5	29,5		24	10

NOTA: articolo di importazione - NOTE: imported item

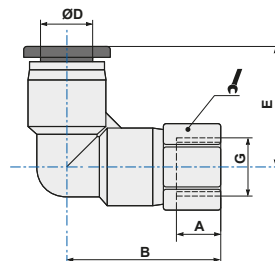

ART. TB22L

Gomito girevole cilindrico lungo
Swivel longer L male adaptor parallel

CODICE	ØD	G	ØB	H	L	L1		
TB22L04M5*	4	M5	11,0	3,5	34,5	19,0	10	25
TB22L0418	4	1/8	9,5	6,0	35,7	17,2	13	25
TB22L06M5*	6	M5	13,0	3,5	36,4	19,2	12	25
TB22L0618	6	1/8	11,5	6,0	35,7	20,8	13	25
TB22L0818	8	1/8	13,5	6,0	38,0	23,0	13	25
TB22L0814*	8	1/4	15,0	7,5	44,3	22,5	17	25

* = di importazione - imported

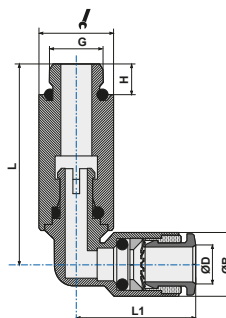

ART. TB22LC

Gomito girevole conico lungo
Swivel longer L male adaptor tapered

CODICE	ØD	G	A	B	ØC	E		
TB22LC0418	4	1/8	7,5	37,0	11,0	19,0	10	25
TB22LC0414	4	1/4	9,5	40,0	11,0	19,0	14	25
TB22LC0618	6	1/8	7,5	39,7	13,0	19,2	12	25
TB22LC0614	6	1/4	9,5	42,2	13,0	19,2	14	25
TB22LC0638	6	3/8	10,5	43,7	13,0	19,2	17	25
TB22LC0818	8	1/8	7,5	44,8	14,4	23,0	14	25
TB22LC0814	8	1/4	9,5	46,8	14,4	23,0	17	25
TB22LC0838	8	3/8	10,5	48,5	14,4	23,0	17	25
TB22LC1018	10	1/8	7,5	54,3	18,5	28,2	17	25
TB22LC1014	10	1/4	9,5	56,3	18,5	28,2	17	25
TB22LC1038	10	3/8	10,5	57,3	18,5	28,2	17	25
TB22LC1012	10	1/2	13,5	60,8	18,5	28,2	21	10
TB22LC1214	12	1/4	9,5	61,5	21,0	29,5	21	10
TB22LC1238	12	3/8	10,5	62,5	21,0	29,5	21	10
TB22LC1212	12	1/2	13,5	65,5	21,0	29,5	21	10

NOTA: articolo di importazione - NOTE: imported item

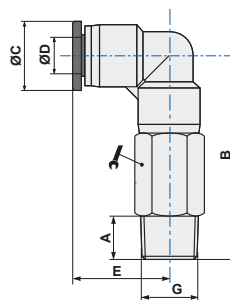

ART. TB23

 Y innestabile
Y connector

CODICE	ØD1	ØD2	ØE	ØB	A	L		
TB230400	4	4	2,40	9,5	19	33,0		50
TB230406	4	6	2,40	11,5	19	35,8		50
TB230600	6	6	2,60	11,5	23	38,6		50
TB230608	6	8	3,20	13,5	23	39,8		50
TB230800	8	8	2,75	16,5	27	42,5		50
TB230810	8	10	3,20	17,0	27	44,4		25
TB231000	10	10	4,30	20,0	34	50,8		25
TB231012*	10	12	4,30	20,0	34	50,8		10
TB231200	12	12	4,20	20,0	40	53,2		10

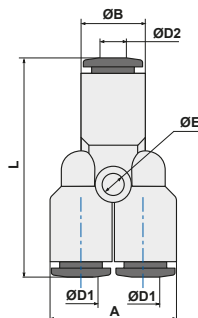
 * = di importazione - *imported*

ART. TB23L0

 Y innestabile
Y connector

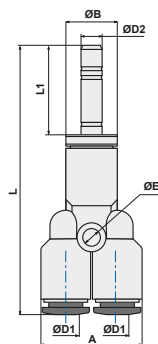
CODICE	ØD1	ØD2	ØB	A	ØE	L	L1	
TB2304L0	4	4	9,5	19	2,40	50,0	16,7	50
TB2306L0	6	6	11,5	23	2,60	58,1	19,5	50
TB2308L0	8	8	13,5	27	2,75	63,5	21,0	50
TB2310L0	10	10	17,0	34	4,30	74,8	24,0	25
TB2312L0	12	12	20,0	40	4,20	78,2	25,0	10

ART. TB23G

 Y innestabile filetto cilindrico con O-Ring
Y connector with swivel parallel male adapter

CODICE	ØD	G	ØA	ØB	H	A	L		
TB23G04M5*	4	M5	2,0	9,5	4,0	19,0	39,1	10	50
TB23G0418	4	1/8	3,0	9,5	5,5	19,0	20,5	13	50
TB23G0414	4	1/4	3,0	11,0	7,5	22,0	45,5	17	50
TB23G0438*	4	3/8	3,0	11,0	7,5	22,0	46,0	20	25
TB23G0618	6	1/8	5,0	11,5	5,5	23,0	34,8	13	50
TB23G0614	6	1/4	5,0	11,5	6,5	23,0	36,4	16	50
TB23G0638*	6	3/8	5,0	13,0	7,5	26,0	47,2	20	25
TB23G0818	8	1/8	7,0	13,5	5,5	27,0	37,5	13	50
TB23G0814	8	1/4	7,0	13,5	6,5	27,0	38,6	16	50
TB23G0838*	8	3/8	6,2	14,4	7,5	29,4	50,5	20	25
TB23G1014*	10	1/4	8,2	18,4	7,5	36,4	58,9	17	25
TB23G1038*	10	3/8	8,2	18,4	7,5	36,4	58,9	20	25
TB23G1012*	10	1/2	8,2	18,4	10	36,4	62,4	24	10
TB23G1214*	12	1/4	9,5	21,0	7,5	42,0	62,3	21	10
TB23G1238*	12	3/8	9,5	21,0	7,5	42,0	62,3	21	10
TB23G1212*	12	1/2	9,5	21,0	10	42,0	65,3	24	10

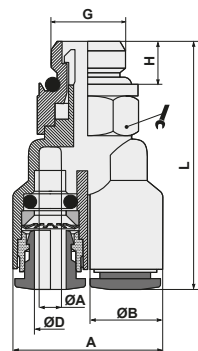
 * = di importazione - *imported*

ART. TB24

Y doppio innestabile
Double Y connector

CODICE	ØD1	ØD2	ØE	ØB	A max	L		
TB240400	4	4	3,2	9,5	20,2	34,5		25
TB240406	4	6	3,2	13,0	20,8	35,5		25
TB240408*	4	8	3,2	14,5	22,2	38,5		25
TB240600	6	6	3,2	11,5	23,9	39,6		25
TB240608*	6	8	3,2	13,5	26,15	41,8		25
TB240800*	8	8	3,5	15,0	28,0	42,0		25
TB240810	8	10	3,2	17,0	28,0	46,5		25

* = di importazione - imported

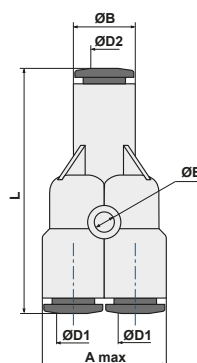

ART. TB24L0

Y doppio innestabile
Double Y connector

CODICE	ØD1	ØD2	ØE	ØB	A	L	L1	
TB2404L0	4	4	2,40	9,5	19	51,2	16,7	25
TB2406L0	6	6	2,60	11,5	23	59,1	19,5	25
TB2408L0	8	8	2,75	13,5	27	67,5	21,0	25

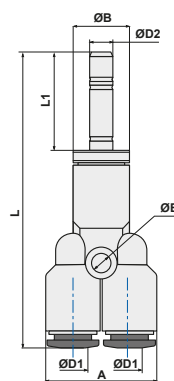

ART. TB33

Doppio anello semplice girevole con asta
Swivel double banjo stem

CODICE	ØD	G	ØA	H	L1	L	⊙	⌘	▮
TB3304M5	4	M5	2,0	4,0	28,0	19,5	2,5	14	22
TB330418	4	1/8	5,5	5,5	43,3	21,1	3	14	25
TB330618	6	1/8	5,5	5,5	43,3	24,3	3	14	25
TB330614	6	1/4	7,8	6,5	50,0	25,5	4	18	25
TB330818	8	1/8	5,5	5,5	43,3	24,8	3	14	25
TB330814	8	1/4	7,8	6,5	50,0	26,5	4	18	25
TB331014	10	1/4	7,8	6,5	50,0	28,4	4	18	25

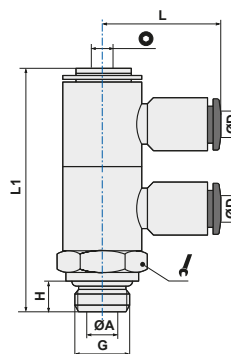

ART. TB33B

Doppio anello due vie girevole con asta
Double branch universal male L

CODICE	ØD	G	ØA	H	L1	L	⊙	⌘	▮
TB33B04M5	4	M5	2,0	4,0	28,0	19,5	2,5	14	10
TB33B0618	6	1/8	5,5	5,5	43,3	24,3	3	14	10
TB33B0814	8	1/4	7,8	6,5	50,0	26,5	4	18	10

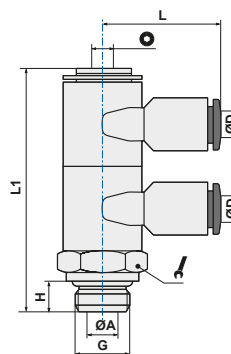

ART. TB34

 Triplo anello semplice girevole con asta
Swivel triple banjo stem

CODICE	ØD	G	ØA	H	L1	L	Ø	🔩	📏
TB340418	4	1/8	5,5	5,5	58,4	21,1	3	14	10
TB340618	6	1/8	5,5	5,5	58,4	24,3	3	14	10
TB340818	8	1/8	5,5	5,5	58,4	24,8	3	14	10
TB340614	6	1/4	7,8	6,5	67	25,5	4	18	10
TB340814	8	1/4	7,8	6,5	67	26,5	4	18	10
TB341014	10	1/4	7,8	6,5	67	28,4	4	18	10

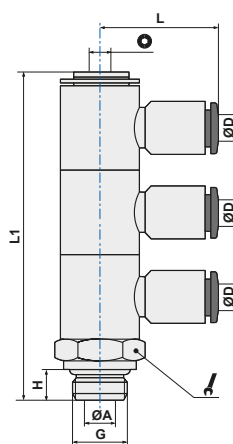
ART. TB34B

 Triplo anello due vie girevole con asta
Triple branch universal male L

CODICE	ØD	G	ØA	H	L1	L	Ø	🔩	📏
TB34B0618	6	1/8	5,5	5,5	58,4	24,3	3	14	10
TB34B0814	8	1/4	7,8	6,5	67	26,5	4	18	10

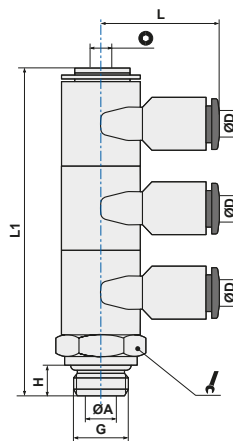
ART. TB90

 Tappo femmina
Tube Blanking Cap

CODICE	ØD	ØD1	L				📏
TB900400	4	11,5	17,5				100
TB900600	6	13,5	17,7				100
TB900800	8	15	21,3				100
TB901000	10	19	25				50
TB901200	12	21,5	26				50

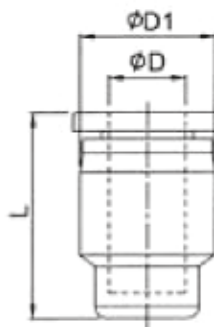
 Adattabile a tutti i raccordi della serie Tecno-RAP
Suitable for all Tecno-RAP fitting series

 Di importazione
Import

BREVE DESCRIZIONE

I raccordi automatici della nostra serie TECNORAP sono realizzati in Italia, a garanzia di elevati standard di qualità secondo le normative ISO di riferimento, e rispondono alle seguenti specifiche tecniche e applicative.

SHORT DESCRIPTION

The TECNORAP series push-in fittings are produced in Italy according to the reference ISO norms as warranty of high quality level and answer to the followings technical specifications and applications.

SCHEDA TECNICA TECHNICAL SHEET

FLUIDI UTILIZZABILI <i>EMPLOYABLE FLUIDS</i>		Aria compressa (per altri fluidi contattare il nostro Ufficio Tecnico) <i>Compressed air (for different fluid pls contact our Technical Dept.)</i>
APPLICAZIONI <i>APPLICATIONS</i>		Pneumatica, idraulica a bassa pressione, secondo normativa DIN 3861-3870. Idonei al funzionamento con il vuoto. <i>Pneumatic circuits, low pressure hydraulic applications, according to DIN 3861-3870 norms. Suitable for vacuum applications.</i>
TUBI CONSIGLIATI <i>SUGGESTED TUBES</i>		TPU (Poliuretano), PA11/PA12 (Poliammide), TPE (Polietilene), TCO (Copoliestere) <i>TPU (Polyurethane), PA11/PA12 (Polyamide), TPE (Polyethylene), TCO (Copolyester)</i>
TOLLERANZE TUBI <i>TUBES TOLERANCES</i>		Diam. da 4 a 10 mm +/- 0,05 Diam. da 12 mm +/- 0,1 <i>Diam. between 4 and 10 mm +/- 0,05 Diam. from 12 mm +/- 0,1</i>
GRADO DI PROTEZIONE <i>INGRESS PROTECTION</i>		"IP 68"
TEMPERATURE E PRESSIONI <i>TEMPERATURE AND PRESSURE</i>	VALORI LIMITE CONSIGLIATI <i>RECOMMENDED LIMIT VALUES</i>	Le temperature e le pressioni dipendono generalmente dalle caratteristiche del tubo impiegato, e comunque si suggerisce di non superare i 12 bar e temperature comprese fra -20°C e +50°C. <i>Temperatures and pressures usually depend by the technical features of the employed tubes, anyway it is suggested a limit working pressure of 12 bar and a temperature range between -20°C and +50°C</i>
	DATI TECNICI DI PROVA <i>TECHNICAL TESTING DATA</i>	A pag. 64 sono riportati i dati di resistenza a trazione e i valori limite di utilizzo (Pressione e Temperature) relativi ai principali tubi commerciali. <i>At page 64 are indicated the load traction resistance values and the main working and breaking limit (Pressure and Temperature) of the main commercial tubing.</i>
	NOTA <i>NOTE</i>	Per dati più puntuali consultare il catalogo tecnico del proprio fornitore di tubi. <i>For more complete informations pls read the technical catalogue of your tube supplier.</i>
FILETTATURE <i>THREAD TYPE</i>		BSP cilindrica UNI-ISO 228; BSP conica UNI-ISO 7; Metrica ISO/R 262. <i>BSP parallel UNI-ISO 228; BSP tapered UNI-ISO 7; Metric ISO/R 262</i>
MATERIALI <i>MATERIALS</i>	corpo, spintore, distanziale, sottomolla <i>body, sleeve, collar and back ring</i>	POM copolimero ISO1043-1 <i>POM copolymer ISO1043-1</i>
	corpi raccordi T01 e basi girevoli serie T22T <i>fittings body T01 and swivel bases T22T series</i>	IXEF tecnopolimero caricato in vetro <i>IXEF technopolymer glass-fiber reinforced</i>
	astine e basi girevoli <i>swivel stems and bases</i>	Ottone UNI EN 12164 CW614N <i>Brass UNI EN 12164 CW614N</i>
	pinza <i>spring</i>	Acciaio Inox AISI 301 austenitico <i>Stainless steel AISI 301 austenitic</i>
	guarnizioni tenuta <i>seals</i>	NBR 70 DWGV-EN549 UL157 <i>NBR 70 DWGV-EN549 UL157</i>

INFORMAZIONI TECNICHE AGGIUNTIVE

Ogni lotto della serie Tecno-RAP viene sottoposto a controlli cosiddetti "rompilotto" durante tutto il ciclo produttivo, che comprendono, oltre all'osservazione estetica, la verifica di funzionalità e di eventuali perdite, un test in pressione a 8 bar per verificarne la conformità anche in condizioni di utilizzo nominali. Successivamente viene eseguito un test a campione di rottura (simulazione scoppio a 50 bar di pressione) con una macchina dedicata che sollecita il raccordo a trazione. Di seguito viene indicata la forza minima di strappo (in Newton) ammessa per ogni diametro:

Diam. tubo <i>Tube diam.</i>	Forza di strappo <i>Breaking load</i>
Ø4	63 N
Ø6	141 N
Ø8	251 N
Ø10	393 N
Ø12	566 N

Nota importante:

I valori indicati si riferiscono alla tenuta della pinza di aggraffaggio, "core part" sia del raccordo Tecno-RAP in tecnopolimero, che del RAP in ottone, per cui omogenei. I valori di rottura sperimentali misurati sono stati, in base al diametro, anche da 1,2 a 2,5 volte superiori.

Informazioni complementari sulle temperature di utilizzo:

Pressione di esercizio e pressione di scoppio (bar) alle diverse temperature Working pressure and breaking pressure (bar) at different temperatures						
Esempio Example	T-20°C	T-20°C	T+23°C	T+23°C	T+60°C	T+60°C
Tube 6x4 colored	P esercizio bar working P bar	P scoppio bar breaking P bar	P esercizio bar working P bar	P scoppio bar breaking P bar	P esercizio bar working P bar	P scoppio bar breaking P bar
TPU	18,7	74,8	10,0	40,0	5,2	20,8
PA11	37,4	149,6	20,0	80,0	10,4	41,6
PA12	48,6	168,3	26,0	90,0	10,4	36,0
PE	18,7	74,8	10,0	40,0	5,0	20,0

Tutte le necessarie valutazioni sull'utilizzo dei raccordi in condizioni di esercizio differenti da quelle suggerite nella scheda tecnica iniziale debbono anche tenere conto, con riferimento alle temperature, dei dati nominali relativi al tubo utilizzato e del limite imposto dal componente più critico.

SERIE TECNORAP: -20°+50° • SERIE RAP : -20° +70°
 SERIE OT: -20° + 80° • SERIE OV : -20° +150°
 SERIE SS:-20° +120°

ADDITIONAL TECHNICAL INFORMATION

Each Tecno-RAP production batch is tested according to severe cyclics "lot breaker" controls along all the production period, which include shape observation, leakage verification, functionality, at the working pressure of 8 bar.

Then all samples taken from the lot are tested by a traction machine which simulate a breaking pressure of 50 bar.

Here below are indicated the traction loads (in Newton) for each size:

Important note:

The values refer to the resistance of the crimping gripper, "core part" of both fittings, the technopolymer Tecno-RAP and the brass RAP, whereby homogeneous. The breaking experimental values measured, according to the diameter, were from 1.2 to 2.5 times higher.

Additional information regarding the working temperatures:

Further to all the necessary assessments on the use of the fittings in operating conditions different from how suggested in the initial technical sheet must be considered, with reference to temperatures, the nominal data regarding the type of the used tube and the limit imposed by the most critical component.

SERIES TECNORAP: -20°+50° • SERIES RAP : -20° +70°
 SERIES OT: -20° + 80° • SERIES OV : -20° +150°
 SERIES SS:-20° +120°





Una nuova missione

In un settore esigente come quello del “Food & Beverage” per soddisfare le richieste dei clienti è necessario realizzare prodotti che, oltre ad assicurare grande affidabilità, siano conformi alle normative internazionali di riferimento.

In quest’ottica nasce la nuova serie di raccordi FCM (Food Contact Material), idonea per il contatto con gli alimenti, e il passaggio di fluidi alimentari, secondo le Normative Europee (Regolamenti) CE 1935/2004, CE 2023/2006, CE 11/2011 e il contatto con acqua potabile secondo il Decreto Ministeriale DM 174/2004.

Requisiti necessari grazie ai quali si vuole offrire ad un mercato in forte evoluzione, una alternativa nuova, con la consapevolezza di aderire ad un cammino che muove i propri passi secondo precisi intendimenti dettati dal nuovo Regolamento Europeo UE 831/2018, conosciuto ormai da tutti gli addetti ai lavori come **MOCA (Fcm)**.

La serie FCM è realizzata da Titan Engineering Spa e si inserisce in un percorso già avviato basato sulla convinzione che sia sempre più necessario orientare le strategie aziendali verso lo sviluppo sostenibile, prestando maggiore attenzione alla salute delle persone e al rispetto dell’ambiente, temi fondamentali nei confronti dei quali l’azienda si presenta già accreditata delle certificazioni ISO14001 e ISO45001, integrate al sistema di gestione qualità ISO9001.

A new mission

In a demanding sector such as “Food & Beverage”, in order to satisfy customers’ requests, products must ensure high reliability and compliance with relevant international standards.

In this perspective born the new series of Fcm (Food Contact Material) fittings, suitable for food contact, and drinkable liquid passage, according to the European regulations 1935/2004, 2023/2006, 11/2011 and for contact with drinking according to the Ministerial Decree 174/2004.

*According to those requirements this new series of fittings offers to an ever-changing market an efficient alternative to adhere to the new European Regulation 831/2018 - otherwise known as **FCM (Moca)**.*

The FCM series, manufactured by Titan Engineering Spa, is part of a route based on the conviction that it is increasingly necessary to direct business strategies towards sustainable development, paying the greatest attention to people’s health and respect for the environment; these are fundamental beliefs for which the company already acquired the ISO14001 and ISO45001 certifications, which are integrated into the quality management system ISO9001.

1 ANELLO DI SOSTEGNO
SUPPORTING RING

2 PINZA DI AGGRAFFAGGIO
CRIMPING GRIPPER

3 DISTANZIALE DI FERMO
LOCK RING

4 ANELLO SPINGITORE
THRUST SLEEVE

5 O-RING DI TENUTA
O-RING SEAL

6 BASE GIREVOLE
SWIVEL BASE

7 CORPO DEL RACCORDO
FITTING BODY

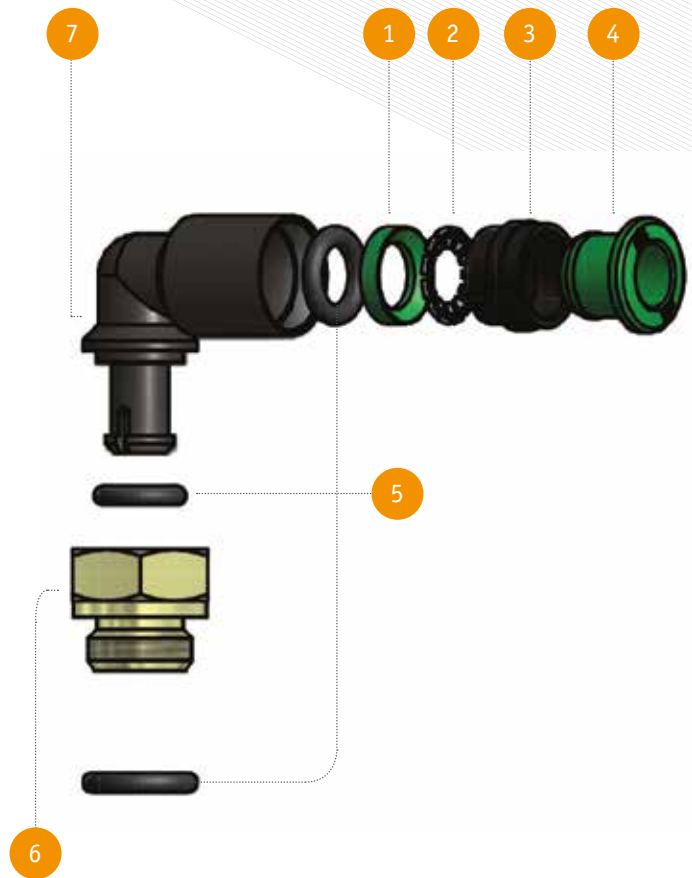

ART. F01

 Dritto cilindrico maschio con O-Ring
Straight male adaptor (parallel)

CODICE	ØD	G	ØC	ØB	H	L			
F0104M5	4	M5	2,6	9	4	20,5	9	2,5	5
F010418	4	1/8	2,6	13,5	5,5	20	9	2,5	5
F010414	4	1/4	2,6	17	6,5	21	9	2,5	5
F0106M5	6	M5	2,6	11	4	22,8	11	2,5	5
F010618	6	1/8	4,2	13,5	5,5	25,3	11	4	5
F010614	6	1/4	4,2	17	6,5	24,3	11	4	5
F010818	8	1/8	5,2	12,8	5,5	27	13	5	5
F010814	8	1/4	6,2	17	6,5	25,5	13	6	5
F011014	10	1/4	7,3	16	6,5	30,4	16	7	5

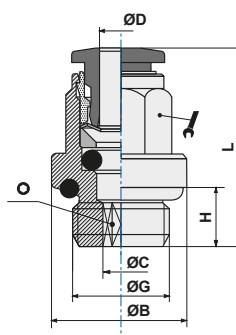
ART. F01T

 Dritto filetto cilindrico maschio con O-Ring
Straight male adaptor (parallel)

CODICE	ØD	G	ØC	ØB	H	L			
F01T0418	4	1/8	2,5	14,0	5,5	19,0	10	2,5	5
F01T0414	4	1/4	2,5	17,5	6,5	20,8	10	2,5	5
F01T0618	6	1/8	4,0	14,0	5,5	24,5	12	4,0	5
F01T0614	6	1/4	4,0	17,5	6,5	26,0	12	4,0	5
F01T0818	8	1/8	5,0	14,0	5,5	25,7	14	5,0	5
F01T0814	8	1/4	6,0	17,5	6,5	27,2	14	6,0	5
F01T1014	10	1/4	7,0	17,5	6,5	28,7	18	7,0	5

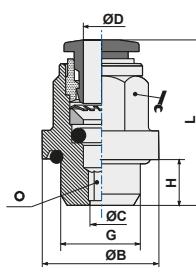
ART. F02

 Dritto femmina
Straight female adaptor

CODICE	ØD	G	ØC	ØB	H	L		
F020418	4	1/8	3	12	6,5	26,5	9	5
F020618	6	1/8	5	12	6,5	28,3	11	5
F020614	6	1/4	5	17	10	31,3	11	5
F020818	8	1/8	7	12	6,5	28,5	13	5
F020814	8	1/4	7	17	10	32,5	13	5

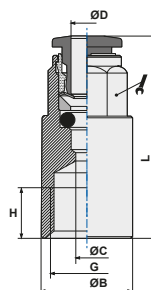
ART. F03

 Dritto innestabile
Straight connector

CODICE	ØD	ØD1	ØC	ØB	ØB1	L	
F030400	4	4	3	9,5	9,5	32,0	5
F030406	4	6	3	9,5	11,5	32,5	5
F030600	6	6	5	11,5	11,5	35,6	5
F030608	6	8	5	11,5	13,5	36,0	5
F030800	8	8	7	13,5	13,5	38,0	5
F030810	8	10	7	13,5	17,0	32,5	5
F031000	10	10	9	17,0	17,0	42,3	5

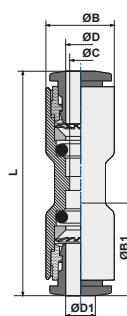
ART. F04

 Gomito innestabile
L connector

CODICE	ØD	ØC	ØB	L	ØE	
F040400	4	3	9,5	17,2	3,2	5
F040600	6	5	11,5	20,8	3,2	5
F040800	8	7	13,5	23,0	3,2	5
F041000	10	9	17,0	26,4	4,3	5

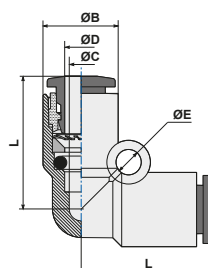

ART. F04LO

 Gomito innestabile con codolo
Plug-in L connector

CODICE	ØD	ØC	ØB	L	L1	ØA	L2	
F0404LO	4	3	9,5	17,2	20,75	4	16,7	5
F0406LO	6	5	11,5	20,8	24,25	6	19,5	5
F0408LO	8	7	13,5	23,0	27,25	8	21,0	5
F0410LO	10	9	17,0	26,4	31,80	10	24,0	5

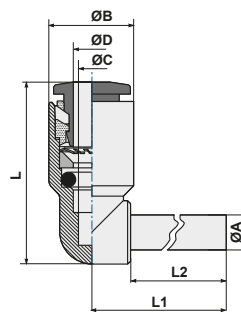
ART. F05

 T innestabile
T connector

CODICE	ØD	ØD1	ØC	ØB	L	
F050400	4	4	3,0	9,5	17,2	5
F050600	6	6	5,0	11,5	20,8	5
F050800	8	8	7,0	13,5	23,0	5
F051000	10	10	9,0	17,0	26,4	5

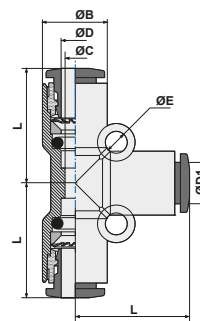
ART. F06

 Innesto filetto cilindrico con O-Ring
Adaptor parallel (short)

CODICE	ØB	F	ØA	ØC	ØD	H	L		
F060418	4	1/8	13	5,5	2	5,5	27,7	13	5
F060618	6	1/8	13	5,5	4	5,5	30,5	13	5
F060614	6	1/4	16	7,5	4	6,5	32,0	13	5
F060818	8	1/8	13	6	6	5,5	32,0	13	5
F060814	8	1/4	16	7,5	6	6,5	33,5	13	5
F061014	10	1/4	16	8	8	6,5	36,5	13	5

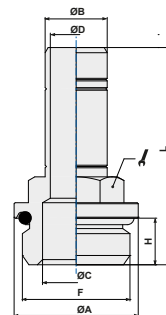
ART. F08

 Riduzione
Reducer

CODICE	ØD1	ØD	ØC	ØB	L	L1	
F080604	6	4	3	9,5	35,5	19,5	5
F080804	8	4	3	9,5	37,0	21,0	5
F081004	10	4	3	9,5	40,0	24,0	5
F081204	12	4	3	9,5	41,0	25,0	5
F080806	8	6	5	11,5	39,05	23,0	5
F081006	10	6	5	11,5	42,05	24,0	5
F081206	12	6	5	11,5	43,05	25,0	5
F081008	10	8	7	13,5	43,0	26,25	5
F081208	12	8	7	13,5	44,0	25,0	5
F081210	12	10	9	17,0	46,15	27,55	5

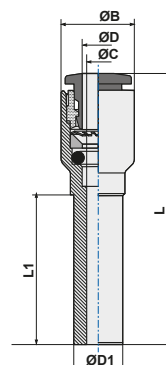

ART. F20

 Raccordo a T centrale girevole
Swivel male stud T parallel

CODICE	ØD	G	ØB	H	L	L1		
F200418	4	1/8	9,5	5,5	17,2	18,5	13	5
F200618	6	1/8	11,5	5,5	20,8	18,5	13	5
F200614	6	1/4	11,5	7,5	20,8	20,4	16	5
F200818	8	1/8	13,5	5,5	23,0	20,0	13	5
F200814	8	1/4	13,5	6,5	23,0	20,4	16	5
F201014	10	1/4	17,0	7,5	26,4	23,2	16	5

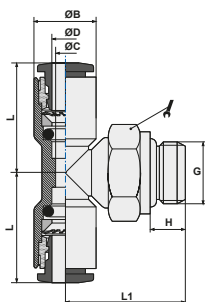
ART. F22

 Gomito girevole maschio in tecnopolimero con O-Ring
Swivel T technopolymer male adaptor

CODICE	ØD	G	ØB	H	L	L1		
F2204M5	4	M5	9,5	4	17,2	17	8	10
F220418	4	1/8	9,5	5,5	17,2	18,5	14	10
F220414	4	1/4	9,5	6,5	17,2	20,4	16	10
F2206M5	6	M5	11,5	4	20,8	17	8	10
F220618	6	1/8	11,5	5,5	20,8	18,5	14	10
F220614	6	1/4	11,5	6,5	20,8	20,4	16	10
F220818	8	1/8	13,5	5,5	23,0	20,0	14	10
F220814	8	1/4	13,5	6,5	23,0	20,4	16	5
F221014	10	1/4	17,0	6,5	26,4	23,2	16	5

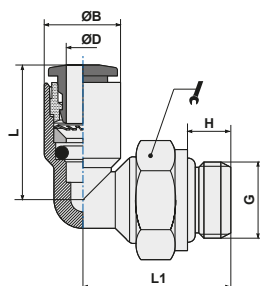
ART. F22T

 Gomito girevole maschio in tecnopolimero con O-Ring
Swivel T technopolymer male adaptor

CODICE	ØD1	G	ØB	H	L	L1		
F22T0418	4	1/8	9,5	5,5	17,2	18,5	14	10
F22T0414	4	1/4	9,5	6,5	17,2	20,4	16	10
F22T0618	6	1/8	11,5	5,5	20,8	18,5	14	10
F22T0614	6	1/4	11,5	6,5	20,8	20,4	16	10
F22T0818	8	1/8	13,5	5,5	23,0	20,0	14	10
F22T0814	8	1/4	13,5	6,5	23,0	20,4	16	10
F22T1014	10	1/4	17,0	6,5	26,4	23,2	16	10

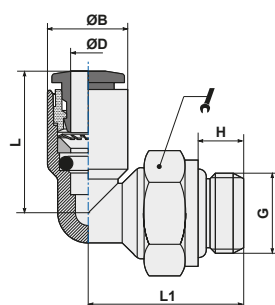
ART. F23

 Y innestabile
Y connector

CODICE	ØD1	ØD2	ØE	ØB	A	L	
F230400	4	4	2,40	9,5	19	33,0	5
F230406	4	6	2,40	11,5	19	35,8	5
F230600	6	6	2,60	11,5	23	38,6	5
F230608	6	8	3,20	13,5	23	39,8	5
F230800	8	8	2,75	16,5	27	42,5	5
F230810	8	10	3,20	17,0	27	44,4	5
F231000	10	10	4,30	20,0	34	50,8	5

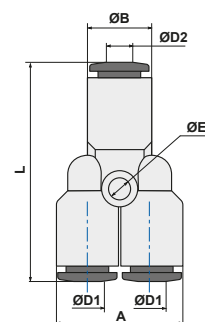
ART. PELD

 Tubo in Polietilene per alimenti (bassa densità)
Polyethilene tube for food applications (low density)

CODICE	Dxd	P	P1	R	
	mm	bar	bar	mm	
PE0402	4x2	18,5	75	20	100
PE0425	4x2,5	15	60	25	100
PE0604	6x4	10	40	40	100
PE0806	8x6	7,5	30	50	100
PE1008	10x8	6	25	120	100

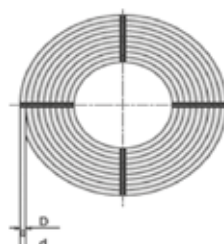

PRESENTAZIONE

Titan Engineering Spa, motivata dall'obiettivo di innovare e progredire e a seguito dei propri studi e ricerche in ambito "food contact", si è impegnata nel progettare e realizzare, in un percorso di crescita sinergico con i principali partners, sia clienti che fornitori, una macchina di prova in grado di soddisfare le richieste di compatibilità e utilizzo dei propri prodotti in campo alimentare, con la possibilità di impiego dei più svariati liquidi.

SCOPO DELLA MACCHINA E DELLE PROVE

Con questi presupposti è nata la macchina denominata: "APC060519TE", vero e proprio strumento di test sviluppato in collaborazione con società esperte e specializzate da tempo nel settore "food contact", grazie alla cui esperienza applicativa sono state assicurate tutte le peculiarità necessarie per garantire il rispetto dei requisiti normativi richiesti, basti pensare che la macchina, in ogni sua parte, è stata costruita utilizzando solo componenti adatti al contatto con gli alimenti e i liquidi potabili. Le prove che si possono eseguire hanno la finalità di validare l'idoneità dei raccordi della nuova serie FCM di Titan Engineering Spa dunque **non solo al contatto, ma anche al passaggio di un determinato fluido alimentare**. Inoltre, i parametri generali di prova (pressione, durata, tipo di fluido, ecc.) possono variare in base alla richiesta del cliente finale, ed in funzione del tipo di applicazione, con il fine di offrire un riscontro quanto più possibile fedele alle reali condizioni di utilizzo.

INTRODUCTION

Titan Engineering Spa, motivated by the target to innovate and progress and following its studies and research in the field of "food contact", has committed itself to designing and implementing, in a path of synergic growth with the main partners, both customers and suppliers, a test machine capable of satisfying the requests for compatibility and use of its products in the food sector, with the possibility of using the most varied liquids.

PURPOSE OF THE MACHINE AND TESTS

With these assumptions the machine named: "APC060519TE" was born, a real test tool developed in collaboration with expert and specialized longtime companies in the "food contact" field, thanks to whose application experience all necessary peculiarities in compliance with the expected regulatory requirements have been ensured, just think that the machine, in all its parts, was built using only components suitable for contact with food and drinking liquids.

*The tests that can be performed have the purpose of validating the suitability of the new FCM fittings series made by Titan Engineering Spa, **so not only on contact, but also on the passage of a specific food fluid**. Furthermore, the general test parameters (pressure, duration, type of fluid, etc.) may change according to the end customer's request and to the type of application, with the aim of offering a response as close as possible to the real use conditions.*



RISULTATI DELLE PROVE E REPORT

I risultati ottenuti dalle prove eseguite, corredati di relativa documentazione fotografica, serviranno per accompagnare, ove richiesto e grazie ad apposita modulistica, la fornitura, costituendone certificazione di idoneità appropriata.

In questa ottica Titan Engineering Spa, in modo preventivo, stà inoltre portando avanti un programma di prove che riguardano i fluidi tra quelli più utilizzati in ambito alimentare, quali: acqua potabile, vino, birra e bevande gassate in genere, in modo da creare una base documentale da mettere a disposizione della Clientela, lasciando a quest'ultima la facoltà di richiedere prove mirate, anche personalizzate, solo quando le proprie esigenze applicative lo dovessero richiedere (a tal proposito è stato previsto un apposito modulo di accesso che dovrà contenere tutte le specifiche necessarie al fine di poter correttamente procedere alle prove di validazione).



CARATTERISTICHE TECNICHE GENERALI

Dimensioni: 74 x 130 x 100.5 cm
 Peso: 160 kg
 Intervallo di pressione testabile: 0-16 Bar
 Intervallo tubazioni testabili: Ø4-Ø14
 Tipi di fluidi testabili: Acqua potabile e qualsiasi fluido ad uso alimentare a richiesta del cliente
 Temperatura di prova: ambiente
 Tipo pompa: Alimentare omologata NFS 169
 Capacità pompa: 100 L/H
 Descrizione tecnica impianto: Tubazioni, raccorderia, macchina, interamente in acciaio inox AISI 316L, omologati per utilizzo con acqua potabile e contatto alimentare

TEST RESULTS AND REPORTS

The results obtained from the carried out tests, supported by proper photographic documentation, will be used, where required and thanks to appropriate forms, to accompany the supply, constituting adequate certification of suitability.

With this in mind, Titan Engineering Spa, in a preventive way, is also carrying out a program of tests concerning the fluids among those most used in the food applications, such as: drinking water, wine, beer and carbonated drinks in general, in order to create a documentary base to be made available to customers, leaving them the chance to request targeted tests, even personalized ones, just when their application needs should require it (in this regard, a special access form, which must contain all specifications necessary in order to correctly proceed to the validation tests, has been prepared).

CERTIFICAZIONI DELLA MACCHINA

Macchina conforme alle norme CE N. 2014/35/UE
 Prove conformi alle norme UNI EN ISO 13846:2001 e superiori
 Documentazione a disposizione:

- Dichiarazione di conformità CE
- Manuale di uso e manutenzione
- Analisi non applicabilità PED
- Scheda analisi e rischi macchina

MACHINE CERTIFICATIONS

*Machine compliant with CE standards 2014/35 / UE
 Tests compliant with UNI EN ISO 13846: 2001 and above
 Available documentation:*

- CE declaration of conformity
- Use and maintenance manual
- PED non-applicability analysis
- Analysis and machine risks sheet

GENERAL TECHNICAL CHARACTERISTICS

*Dimensions: 74 x 130 x 100.5 cm
 Weight: 160 kg
 Testable pressure range: 0-16 Bar
 Testable piping sizes: from Ø4 to Ø14
 Types of testable fluids: Drinking water and any fluid for food use at the customer's request
 Test temperature: environment
 Pump type: NFS 169 food approved
 Pump capacity: 100 L / H
 Plant technical description: Pipes, fittings, machine, entirely in AISI 316L stainless steel, approved for use with drinking water and food contact*

Test funzionali eseguiti con macchina APC060519TE
Functional tests performed with machine APC060519TE

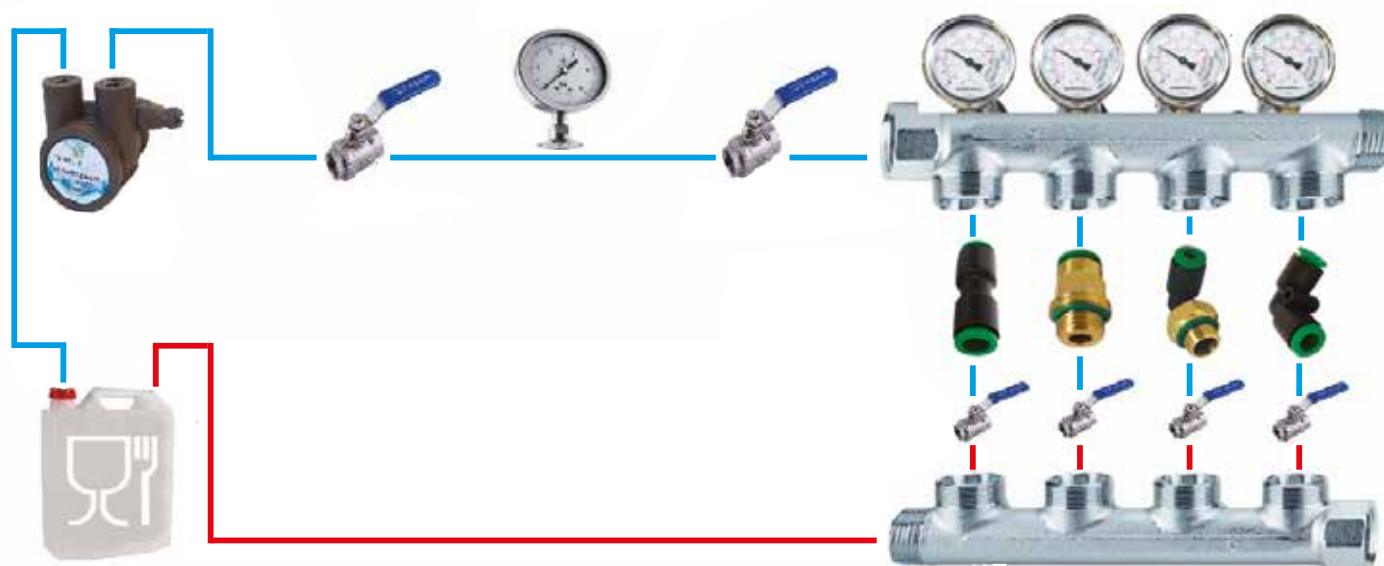

CONDIZIONI DI PROVA <i>TEST CONDITION</i>	Pressione <i>Pressure</i>	8 bar costante / <i>Constant 8 bar</i>			
	Circuito <i>Circuit</i>	Chiuso / <i>Closed</i>			
	Temperatura <i>Temperature</i>	Ambiente / <i>Environment 22°C-30°C</i>			
	Durata <i>Duration</i>	2400 h in continuo / <i>continuously</i>			
	Tipo di fluido / <i>type of fluid</i>				
		Acqua potabile/ <i>Drinking water</i>	Vino / <i>wine</i>	Birra / <i>beer</i>	Bevanda gassata/ <i>Sparkling soft drink</i>
RISULTATI DI PROVA <i>TEST RESULTS</i>	Perdita di liquido <i>Liquid leakage</i>	Nessuna/ <i>None</i>	Nessuna/ <i>None</i>	Nessuna/ <i>None</i>	Nessuna/ <i>None</i>
	Perdita di pressione <i>Pressure loss</i>	Nessuna/ <i>None</i>	Nessuna/ <i>None</i>	Nessuna/ <i>None</i>	Nessuna/ <i>None</i>
	Esito <i>Outcome</i>	Positivo/ <i>Passed</i>	Positivo/ <i>Passed</i>	Positivo/ <i>Passed</i>	Positivo/ <i>Passed</i>

TEST DI MIGRAZIONE

I test di migrazione globale e specifica descritti in tabella servono a determinare i quantitativi migrati e il successivo controllo di rientro nei limiti imposti dalle normative, vengono eseguiti per controllare i fenomeni di migrazione dei materiali a contatto con alimenti.

MIGRATION TEST

The global and specific migration tests shown in the table are used to determine the quantities migrated and the subsequent control of re-entry within the limits imposed by the regulations, are carried out to check the migration phenomena of materials in contact with food.

TIPO DI TEST ESEGUITO	COMPONENTI	ESITO PROVA
Migrazione globale, migrazione specifica coloranti, migrazione specifica metalli. Simulanti: A,B,D2 + prova di migrazione mine aromatiche primarie simulante B.	Tappo spintore	Positivo
	Corpi raccordo (POM)	Positivo
	Corpi e basi girevoli raccordo (Ixef1022 FC)	Positivo
Migrazione globale + Simulante acido citrico	Corpi e basi girevoli raccordo (CW510L-OT57)	Positivo
Prova di migrazione specifica Cr, Ni, Mn simulante B	Pinza stringitubo	Positivo
Prova di migrazione globale gomma simulante A + prova di migrazione specifica simulante B	Guarnizioni di tenuta	Positivo
A: Etanolo 10%; B: Acido acetico 3%; C: Etanolo 20%; D1: Etanolo 50%; D2: Olio vegetale; E: Poli (ossido di 2,6-difenil-p-fenilene) (Tenax).		

TYPE OF TEST PERFORMED	COMPONENTS	TEST RESULT
Global migration, specific migration of dyes, specific migration of metals. Simulants: A, B, D2 + primary aromatic mine migration test simulant B	Thrus sleeve	Passed
	Fitting body (POM)	Passed
	Fitting body and swivel base (Ixef1022 FC)	Passed
Global migration + Citric acid simulant	Fitting body and swivel base (CW510L-OT57)	Passed
Specific migration test Cr, Ni, Mn simulant B	Crimping Gripper	Passed
Global migration test simulant rubber A + specific migration test simulant B	O-ring seal	Passed
A: 10% ethanol; B: 3% acetic acid; C: 20% ethanol; D1: 50% ethanol; D2: Vegetable oil; E: Poly (2,6-diphenyl-p-phenylene oxide) (Tenax).		

I limiti di migrazione specifica, sono rispettati nelle condizioni d'uso sopra menzionate.

The specific migration limits are respected in the conditions of use mentioned above.

BREVE DESCRIZIONE

I raccordi automatici della serie “Food Contact Material” sono realizzati in Italia, a garanzia di elevati standard di qualità secondo le normative ISO di riferimento, e rispondono alle seguenti specifiche tecniche e applicative.

SHORT DESCRIPTION

The “Food Contact Material” push-in fittings series are produced in Italy according to the reference ISO norms as warranty of high quality level and answer to the following technical specifications and applications.

SCHEDA TECNICA TECHNICAL SHEET

FLUIDI UTILIZZABILI <i>EMPLOYABLE FLUIDS</i>		Aria compressa e principali fluidi alimentari <i>Compressed air and main food fluids</i>
APPLICAZIONI <i>APPLICATIONS</i>		Pneumatica applicata alle macchine destinate al settore alimentare (packaging, insacchettatrici, sottovuoto, enologia, ecc.) e macchine per passaggio fluidi alimentari a basse temperature (filling, imbottigliamento, spillatura, ecc.) <i>Compressed air applied to machines intended for the food and beverage field (boxing, bagging machines, vacuum packaging, oenology, etc.) and machines for the passage of low temperature drinkable fluids (filling, bottling, tapping, etc.)</i>
TUBI CONSIGLIATI <i>SUGGESTED TUBES</i>		TPU, PA11/PA12, TPE, TCO per aria compressa. PE, PVC, PELD per fluidi alimentari. <i>TPU, PA11 / PA12, TPE, TCO for compressed air. PE, PVC, PELD for food fluids.</i>
TOLLERANZE TUBI <i>TUBES TOLERANCES</i>		Diam. da 4 a 10 mm +/- 0,05 <i>Diam. between 4 and 10 mm +/- 0,05</i>
GRADO DI PROTEZIONE <i>INGRESS PROTECTION</i>		“” IP 68 “”
TEMPERATURE E PRESSIONI <i>TEMPERATURE AND PRESSURE</i>	VALORI LIMITE CONSIGLIATI <i>RECOMMENDED LIMIT VALUES</i>	Le temperature e le pressioni dipendono generalmente dalle caratteristiche del tubo impiegato, e comunque si suggerisce di non superare i 15 bar e temperature comprese fra -20°C e +70°C. <i>Temperatures and pressures usually depend by the technical features of the employed tubes, anyway it is suggested a limit working pressure of 15 bar and a temperature range between -20°C and +70°C</i>
	DATI TECNICI DI PROVA <i>TECHNICAL TESTING DATA</i>	A pag. 76 sono riportati i dati di resistenza a trazione e i valori limite di utilizzo (Pressione e Temperature) relativi ai principali tubi commerciali. <i>At page 76 are indicated the load traction resistance values and the main working and breaking limit (Pressure and Temperature) of the main commercial tubing.</i>
	NOTA <i>NOTE</i>	Per dati più puntuali consultare il catalogo tecnico del proprio fornitore di tubi. <i>For more complete informations pls read the technical catalogue of your tube supplier.</i>
FILETTATURE <i>THREAD TYPE</i>		BSP cilindrica UNI-ISO 228; Metrica ISO/R 262. <i>BSP parallel UNI-ISO 228; Metric ISO/R 262</i>
MATERIALI <i>MATERIALS</i>	corpo e basi girevoli <i>body and swivel bases</i>	Ottone UNI EN 12164 CW510L (NSF372) <i>Brass UNI EN 12164 CW510L (NSF372)</i>
	spintore, distanziale, sottomolla / <i>sleeve, collar and back ring</i>	POM copolimero ISO1043-1 (REG. UE 10/2011) <i>POM copolymer ISO1043-1 (REG. UE 10/2011)</i>
	pinza <i>spring</i>	Acciaio Inox AISI 301 austenitico <i>Stainless steel AISI 301 austenitic</i>
	guarnizioni tenuta <i>seals</i>	NBR 70 DWGV-EN549 UL157 <i>NBR 70 DWGV-EN549 UL157</i>

INFORMAZIONI TECNICHE AGGIUNTIVE

Ogni lotto della serie FCM viene sottoposto a controlli cosiddetti "rompilotto" durante tutto il ciclo produttivo, che comprendono, oltre all'osservazione estetica, la verifica di funzionalità e di eventuali perdite, un test in pressione a 8 bar per verificarne la conformità anche in condizioni di utilizzo nominali. Successivamente viene eseguito un test a campione di rottura (simulazione scoppio a 50 bar di pressione) con una macchina dedicata che sollecita il raccordo a trazione. Di seguito viene indicata la forza minima di strappo (in Newton) ammessa per ogni diametro:

Diam. tubo <i>Tube diam.</i>	Forza di strappo <i>Breaking load</i>
Ø4	63 N
Ø6	141 N
Ø8	251 N
Ø10	393 N

Nota importante:

I valori indicati si riferiscono alla tenuta della pinza di aggraffaggio, "core part" sia del raccordo RAP in ottone, che del Tecno-RAP in tecnopolimero, per cui omogenei. I valori di rottura sperimentali misurati sono stati, in base al diametro, anche da 1,2 a 2,5 volte superiori.

Informazioni complementari sulle temperature di utilizzo:

Pressione di esercizio e pressione di scoppio (bar) alle diverse temperature <i>Working pressute and breaking pressutre (bar) at different temperatures</i>						
Esempio <i>Example</i>	T-20°C	T-20°C	T+23°C	T+23°C	T+60°C	T+60°C
Tubo 6x4 colorato <i>Tube 6x4 colored</i>	P esercizio bar <i>working P bar</i>	P scoppio bar <i>breaking P bar</i>	P esercizio bar <i>working P bar</i>	P scoppio bar <i>breaking P bar</i>	P esercizio bar <i>working P bar</i>	P scoppio bar <i>breaking P bar</i>
TPU	18,7	74,8	10,0	40,0	5,2	20,8
PA11	37,4	149,6	20,0	80,0	10,4	41,6
PA12	48,6	168,3	26,0	90,0	10,4	36,0
PE	18,7	74,8	10,0	40,0	5,0	20,0

Tutte le necessarie valutazioni sull'utilizzo dei raccordi in condizioni di esercizio differenti da quelle suggerite nella scheda tecnica iniziale debbono anche tenere conto, con riferimento alle temperature, dei dati nominali relativi al tubo utilizzato e del limite imposto dal componente più critico.

ADDITIONAL TECHNICAL INFORMATIONS

Each FCM production batch is tested according to severe cyclics "lot breaker" controls along all the production period, which include shape observation, leakage verification, functionality, at the working pressure of 8 bar.

Then all samples taken from the lot are tested by a traction machine which simulate a breaking pressure of 50 bar.

Here below are indicated the traction loads (in Newton) for each size:

Important note:

The values refer to the resistance of the crimping gripper, "core part" of both fittings, the brass RAP and the technopolymer Tecno-RAP, whereby homogeneous. The breaking experimental values measured, according to the diameter, were from 1.2 to 2.5 times higher.

Additional information regarding the working temperatures:

Further to all the necessary assessments on the use of the fittings in operating conditions different from how suggested in the initial technical sheet must be considered, with reference to temperatures, the nominal data regarding the type of the used tube and the limit imposed by the most critical component.

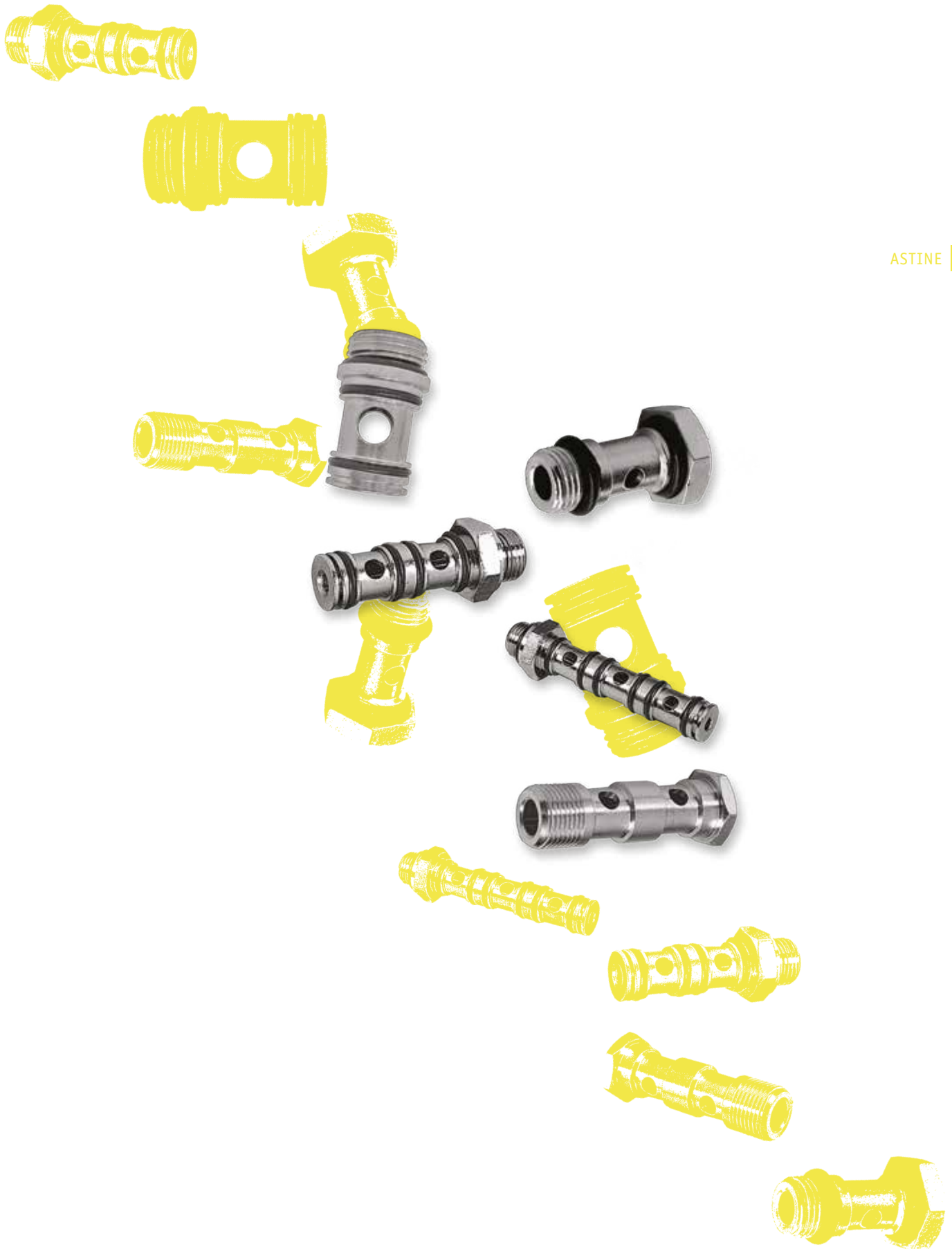

ASTINE

- 1 O-RING ESTERNO
EXTERNAL O-RING
- 2 ASTINA GIREVOLE MODELLO 15A
SWIVEL STEM 15A TYPE
- 3 ASTINA FISSA MODELLO 407
FIX STEM 407 TYPE
- 4 O-RING INTERNO
INTERNAL O-RING
- 5 ANELLO GIREVOLE MODELLO T13
SWIVEL BANJO T13 TYPE
- 6 ANELLO ELASTICO
ELASTIC RING

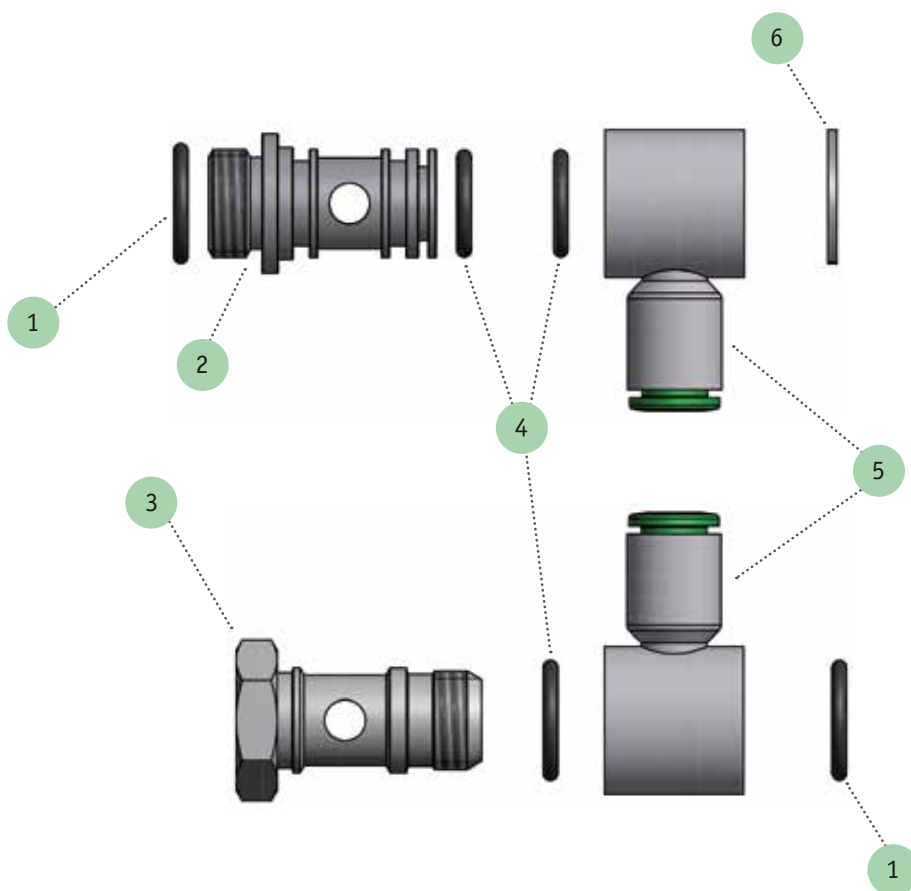

ART. 407

Vite cava semplice con O-Ring
Banjo stem single with O-Ring

CODICE	A	B	C	L		
40718	G1/8	4,5	13,75	25	14	100
40714	G1/4	9,9	16,7	30	17	50
40738	G3/8	6	18	34	22	25

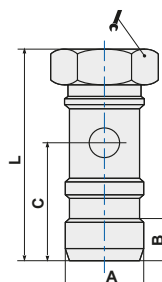

ART. 407V

Vite cava semplice
Banjo stem single

CODICE	A	B	C	L		
407M5	M5	5,8	9,6	18	8	100
40718V	G1/8	9	15	28	14	100
40714V	G1/4	11	18	33	17	50
40738V	G3/8	12	21,5	37	22	50

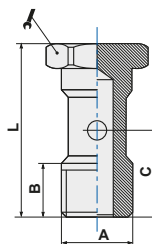

ART. 408

Vite cava doppia con O-Ring
Banjo stem double with O-Ring

CODICE	A	B	C	D	L		
40818	G1/8	4,5	13	29	40	14	50
40814	G1/4	6	16,5	33,5	47	17	50
40838	G3/8	8,5	18	37,6	52,5	22	25
40812	G1/2	7,4	21,5	45	63	27	10

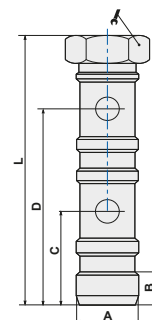

ART. 408V

Vite cava doppia
Banjo stem double

CODICE	A	B	C	D	L		
40818V	G1/8	9	15	31	44,5	14	50
40814V	G1/4	11	17	36	51,5	17	50
40838V	G3/8	12	20,5	42	58,6	22	25
40812V	G1/2	14	24	50	68	24	10

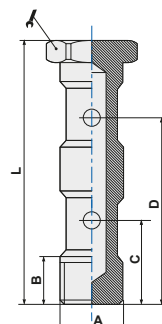

ART. 15A

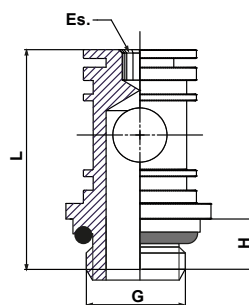

Asta singola per anello girevole
Single stem for swivel banjo

CODICE	G	L	ES.	H	
15AM5	M5	17	2,5	4,0	10
15AM5L	M5	18	2,5	4,0	10
15AM6L	M6	19	2,5	5,0	10
15A18	1/8	24,5	3	5,5	10
15A14	1/4	28	4	6,5	10
15A38	3/8	32,5	5	7,5	10
15A12	1/2	39	8	10,0	10



ART. 33A

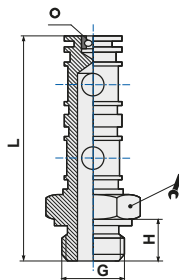

Asta doppia per anello girevole
Double stem for swivel banjo

CODICE	G	H	L				
33AM5L	M5	4,0	28,0		N.C.	2,5	50
33A18	1/8	5,5	43,3		14	3	50
33A14	1/4	6,5	50,0		18	4	50



ART. 34A

Asta tripla per anello girevole
Triple stem for swivel banjo

CODICE	G	H	L				
34A18	1/8	5,5	58,4		14	3	50
34A14	1/4	6,5	67,1		18	4	25

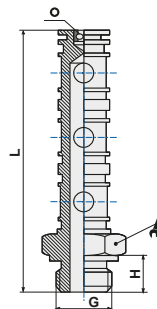

ART. 411

Rondella distanziatrice
Spacer washer

CODICE	A	ØB	ØD	H	
411PM5	M5	9	5,1	1,5	100
411P18	G1/8	14	9,8	1,5	100
411P14	G1/4	18	13,5	1,5	100
411P38	G3/8	21	16,7	1,5	100
411P12	G1/2	26	21,1	2	100
411M5	M5	8,8	5,2	1	100
41118	G1/8	13,8	9,8	1,5	100
41114	G1/4	18	13,2	1,5	100
41138	G3/8	21	16,8	1,5	100
41112	G1/2	26	20,8	1,5	100
41134	G3/4	32,8	26,8	1,5	100

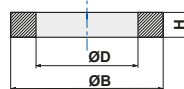

P = versione in nylon
P = nylon material
A = taglia - A = size

BREVE DESCRIZIONE

Le astine, serie 407 e superiori e 15A e superiori, per l'impiego con i nostri raccordi tipo anelli girevoli, automatici e non, sono realizzati in Italia, a garanzia di elevati standard di qualità, secondo le normative ISO di riferimento.

SHORT DESCRIPTION

Stems, 407 series and higher, and 15A series, employed with our banjo fittings (push-in type, quick type, etc.) are produced in Italy according to the reference ISO norms as warranty of high quality level.

SCHEDA TECNICA TECHNICAL SHEET

FLUIDI UTILIZZABILI <i>EMPLOYABLE FLUIDS</i>		Aria compressa, acqua fino 100 °C (per altri fluidi contattare il nostro UT) <i>Compressed air, water up to 100 °C (for different fluid pls contact our Technical Dept.)</i>
APPLICAZIONI <i>APPLICATIONS</i>		Pneumatica, idraulica a bassa pressione, secondo normativa DIN 3861-3870 <i>Pneumatic circuits, low pressure hydraulic applications, according to DIN 3861-3870 norms</i>
TEMPERATURE E PRESSIONI <i>TEMPERATURES AND PRESSURES</i>		Le temperature e le pressioni dipendono generalmente dalle caratteristiche del tubo impiegato <i>Temperatures and pressures usually depend by the technical features of the employed tubes</i>
FILETTATURE <i>THREAD TYPE</i>		BSP cilindrica UNI-ISO 228 BSP conica UNI-ISO 7 Metrica ISO/R 262 <i>BSP parallell UNI-ISO 228 BSP tapered UNI-ISO 7 Metric ISO/R 262</i>
MATERIALI <i>MATERIALS</i>	corpo <i>body</i>	Ottone UNI EN 12164 CW614N <i>Brass UNI EN 12164 CW614N</i>
	guarnizioni tenuta <i>seals</i>	NBR 70 DWGV-EN549 UL157 <i>NBR 70 DWGV-EN549 UL157</i>
	rondelle <i>washers</i>	Nylon/Alluminio <i>Nylon/Aluminium</i>



1

ISTRUZIONI DI MONTAGGIO - *FITTING INSTRUCTIONS*

Prima dell'inserimento - *Before the insertion*

- Il tipo di tubo utilizzato deve essere dichiarato dal costruttore idoneo all'utilizzo con raccordi automatici
The type of employed pipe must be declared as suitable by the manufacturer to be used with push-in fittings
- Il taglio del tubo deve essere effettuato a 90° mediante apposita pinza taglia tubo (Vedi nostro catalogo bluline)
The cutting of the pipe must be at a right angle using a dedicated tube cutter (See our bluline catalogue)
- Non effettuare il taglio del tubo con forbici, tenaglie o altri utensili che possano conferire all'estremità del tubo estremità non lineari
Do not cut the hose with scissors, pincers or other tools that may cause non-linear surface to the end of the tube



2

INSERIMENTO CORRETTO DEL TUBO SUL RACCORDO

CORRECT INSERTION OF THE HOSE IN THE FITTING



3

FOTO 1 - *PICTURE 1*

Tubo prima dell'inserimento - *Hose before insertion*

FOTO 2 - *PICTURE 2*

Tubo inserito - *Inserted hose*

FOTO 3 - *PICTURE 3*

Tubo tagliato a 90° con pinza in plastica - *Tubo tagliato a 90° con pinza*



4

FOTO 4 - *PICTURE 4*

Tubo tagliato in modo corretto con pinza in metallo - *Correct hose cut with metal tube cutter*

Durante l'inserimento - *During the insertion*

- Effettuare una leggera rotazione del tubo in modo da agevolarne l'ingresso, assicurarsi di arrivare con il tubo fino a quota di battuta interna.
Turn the hose slightly so to make it easier to get in, make sure the pipe reach the inside stop.

Sgancio del tubo - *Hose extraction*

- Per effettuare lo sgancio del tubo, o disinnesto, premere il tappo spintore fino a battuta, mantenendo la pressione su quest'ultimo estrarre il tubo dal corpo (l'operazione può essere facilitata con l'utilizzo di apposita forchettina).
To extract the hose, or realising it, press the sleeve until it stops and keeping it pressed remove the tube from the fitting (the operation can be done easier using an appropriate fork).
- Assicurarsi che il tubo inserito non sia soggetto a trazione e che il tappo spintore non venga a contatto con nessun tipo di oggetto in modo da non generare sganci o sfilamenti involontari.
Make sure that the inserted hose is not under traction and that the sleeve does not run the risk of accidental contacts which may cause unintentional extraction or releasing.



5

FOTO 5 - *PICTURE 5*

Raccordo con tubo inserito e in trazione - *Fitting with inserted hose, in tension*

FOTO 6 - *PICTURE 6*

Raccordo con tubo inserito avente raggio di curvatura stretto - *Fitting with hose inserted, having a tight bending radius*



6

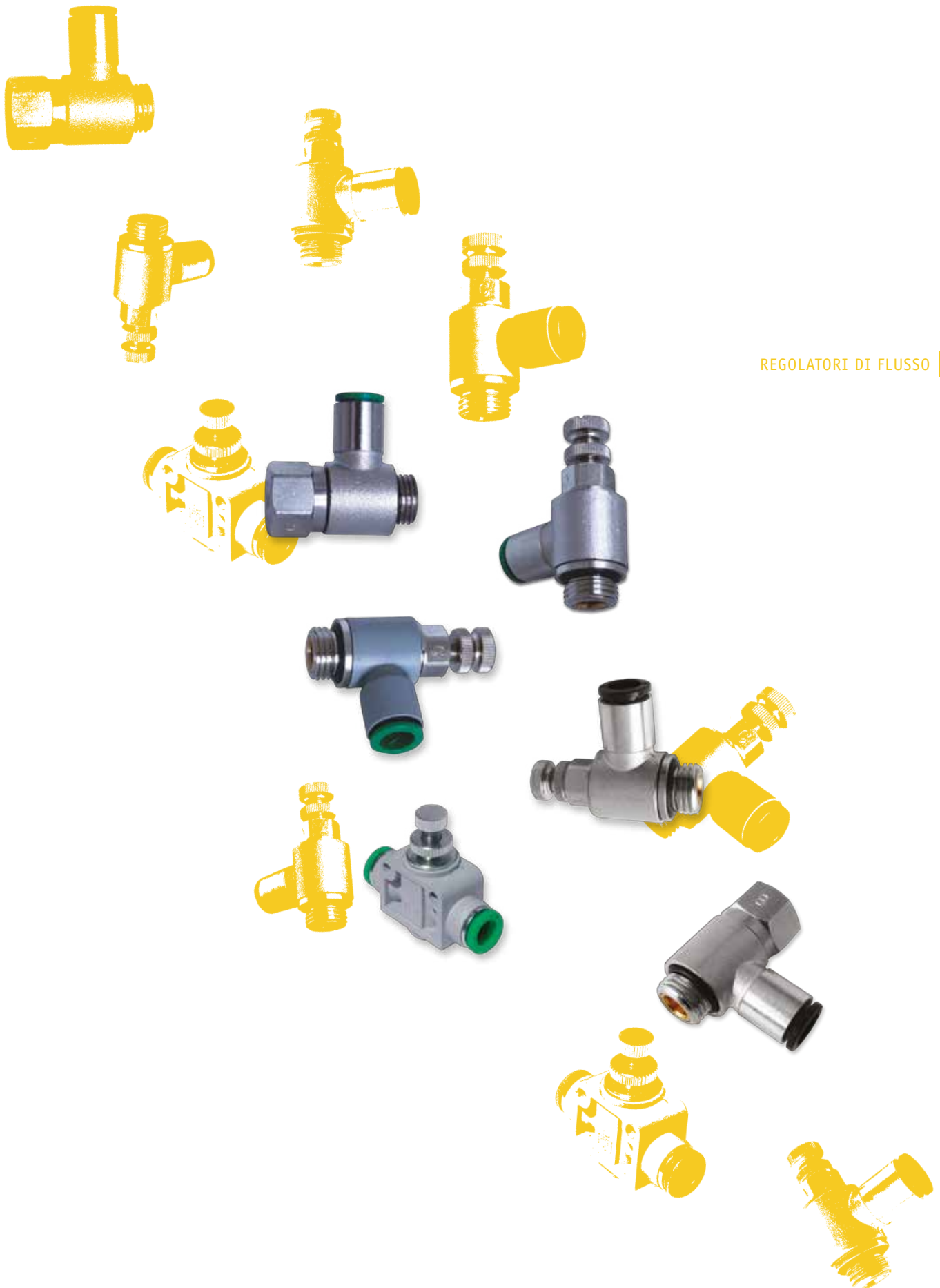

REGOLATORI DI FLUSSO

- 1 **RAP**
Anello girevole - Swivel banjo "13" "13 R/*"
- 2 **TECNO-RAP**
Anello girevole - Swivel banjo "T13" "T13 R/*"
- 3 **Asta di regolazione con pomolo**
Adjusting stem with knob
28A (per valvola - for valve)
29A (per cilindro - for cylinder)
30A (bidirezionale - bidirectional)
- 4 **Asta di regolazione con taglio a cacciavite**
Adjusting stem with screwdriver cut
28A (per valvola - for valve)
29A (per cilindro - for cylinder)
30A (bidirezionale - bidirectional)

(*) Per asta M5
For M5 stem



CODIFICA DEI REGOLATORI DI FLUSSO

A	B	C	D	E
	28	04	18	
T	29	06	18	P

ESEMPI DI ORDINAZIONE

CODING OF FLOW REGULATORS

A	B	C	D	E
	28	04	18	
T	29	06	18	P

ORDERING EXAMPLES

A =		VERSIONE CON CORPO IN OTTONE
	T	VERSIONE CON CORPO IN TECNOPOLIMERO

A =		BRASS BODY VERSION
	T	TECHNOPOLYMER VERSION

B =	28	PER VALVOLA
	29	PER CILINDRO
	30	BIDIREZIONALE

B =	28	FOR VALVE
	29	FOR CYLINDER
	30	BIDIRECTIONAL

C =	04	PER TUBO DIAM. 4 MM
	06	PER TUBO DIAM. 6 MM
	08	PER TUBO DIAM. 8 MM
	10	PER TUBO DIAM. 10 MM
	12	PER TUBO DIAM. 12 MM

C =	04	FOR TUBE DIAM. 4 MM
	06	FOR TUBE DIAM. 6 MM
	08	FOR TUBE DIAM. 8 MM
	10	FOR TUBE DIAM. 10 MM
	12	FOR TUBE DIAM. 12 MM

D =	M5	FILETTATURA M5
	18	FILETTATURA 1/8
	14	FILETTATURA 1/4
	38	FILETTATURA 3/8
	12	FILETTATURA 1/2

D =	M5	THREAD M5
	18	THREAD 1/8
	14	THREAD 1/4
	38	THREAD 3/8
	12	THREAD 1/2

E =		ORIENTABILE CON TAGLIO A CACCIAVITE
	P	GIREVOLE CON POMELLO DI REGOLAZIONE

E =		ORIENTABLE TYPE WITH SCREWDRIVER CUT
	P	SWIVEL TYPE WITH ADJUSTING KNOB

ART. 28

Regolatore di flusso orientabile per valvola
Orientable flow regulator for valve

CODICE	ØD	G	ØA	H	L1	L		
2804M5	4	M5	1,9	4,0	19,5	24,0	8	25
280418	4	1/8	5,5	5,5	21,1	34,0	14	25
2806M5	6	M5	1,9	4,0	21,0	24,0	8	25
280618	6	1/8	5,5	5,5	24,3	34,0	14	25
280614	6	1/4	6,0	6,5	25,5	42,0	17	25
280818	8	1/8	5,5	5,5	24,8	34,0	14	25
280814	8	1/4	6,0	6,5	26,5	42,0	17	25
280838	8	3/8	8,0	7,5	28,0	52,0	20	10
281014	10	1/4	6,0	6,5	28,4	42,0	17	25
281038	10	3/8	8,0	7,5	29,9	52,0	20	10
281238	12	3/8	8,0	7,5	31,4	52,0	20	10

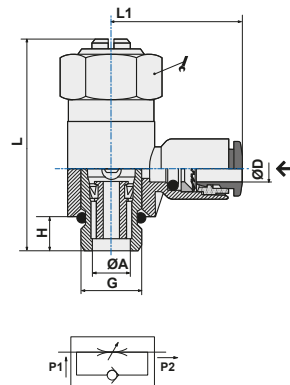

ART. 29

Regolatore di flusso orientabile per cilindro
Orientable flow regulator for cylinder

CODICE	ØD	G	ØA	H	L1	L		
2904M5	4	M5	1,9	4,0	19,5	24,0	8	25
290418	4	1/8	5,0	5,5	21,1	34,0	14	25
2906M5	6	M5	1,9	4,0	21,0	24,0	8	25
290618	6	1/8	5,0	5,5	24,3	34,0	14	25
290614	6	1/4	6,0	6,5	25,5	42,0	17	25
290818	8	1/8	5,0	5,5	24,8	34,0	14	25
290814	8	1/4	6,0	6,5	26,5	42,0	17	25
290838	8	3/8	6,5	7,5	28,0	52,0	20	10
291014	10	1/4	6,0	6,5	28,4	42,0	17	25
291038	10	3/8	6,5	7,5	29,9	52,0	20	10
291238	12	3/8	6,5	7,5	31,4	52,0	20	10
291212	12	1/2	10,0	9	34,9	61,0	26	10

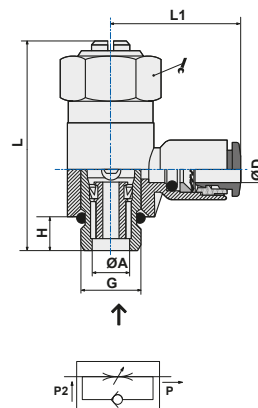

ART. 30

Regolatore di flusso orientabile bidirezionale
Orientable bidirectional flow regulator

CODICE	ØD	G	H	L1	L		
3004M5	4	M5	4,0	19,5	24	8	25
300418	4	1/8	5,5	21,1	34	14	25
3006M5	6	M5	4,0	21,0	24	8	25
300618	6	1/8	5,5	24,3	34	14	25
300614	6	1/4	6,5	25,5	42	17	25
300818	8	1/8	5,5	24,8	34	14	25
300814	8	1/4	6,5	26,5	42	17	25
300838	8	3/8	7,5	28,0	52	20	10
301014	10	1/4	6,5	28,4	42	17	25
301038	10	3/8	7,5	29,9	52	20	10
301238	12	3/8	7,5	31,4	52	20	10
301212	12	1/2	9	34,9	61	26	10

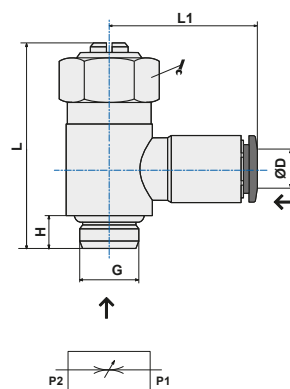

ART. 28P

 Regolatore di flusso girevole per valvola
Swivel flow regulator for valve

CODICE	ØD	G	H	L1	L		
2804M5P	4	M5	4	19,5	35,0	8	25
280418P	4	1/8	5,5	43,0	21,1	9	25
2806M5P	6	M5	4	21,0	35,0	8	25
280618P	6	1/8	5,5	43,0	24,3	9	25
280818P	8	1/8	5,5	43,0	24,8	9	25
280614P	6	1/4	6,5	50,0	25,5	12	25
280814P	8	1/4	6,5	50,0	26,5	12	25
281014P	10	1/4	6,5	50,0	28,4	12	25

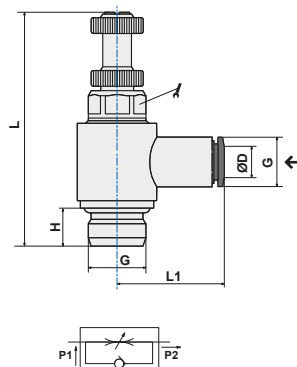
ART. 29P

 Regolatore di flusso girevole per cilindro
Swivel flow regulator for cylinder

CODICE	ØD	G	H	L1	L		
2904M5P	4	M5	4	19,5	35,0	8	25
290418P	4	1/8	5,5	43,0	21,1	9	25
2906M5P	6	M5	4	21,0	35,0	8	25
290618P	6	1/8	5,5	43,0	24,3	9	25
290818P	8	1/8	5,5	43,0	24,8	9	25
290614P	6	1/4	6,5	50,0	25,5	12	25
290814P	8	1/4	6,5	50,0	26,5	12	25
291014P	10	1/4	6,5	50,0	28,4	12	25

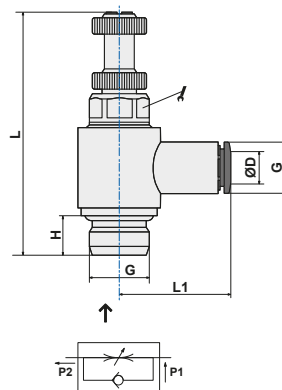
ART. 30P

 Regolatore di flusso girevole bidirezionale
Swivel bidirectional flow regulator

CODICE	ØD	G	H	L1	L		
3004M5P	4	M5	4	19,5	35,0	8	25
300418P	4	1/8	5,5	43	21,1	9	25
3006M5P	6	M5	4	21	35,0	8	25
300618P	6	1/8	5,5	43	24,3	9	25
300818P	8	1/8	5,5	43	24,8	9	25
300614P	6	1/4	6,5	50	25,5	12	25
300814P	8	1/4	6,5	50	26,5	12	25
301014P	10	1/4	6,5	50	28,4	12	25

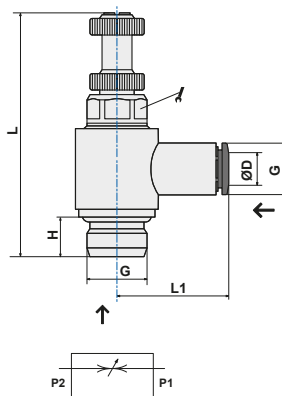

ART. B28

Regolatore di flusso unidirezionale per valvola
Unidirectional flow regulator for valve

CODICE	ØD	G	ØA	H	L1	L		
B2804M5	4	M5	1,9	4,0	19,5	24,0	8	25
B280418	4	1/8	5,5	5,5	21,1	34,0	14	25
B2806M5	6	M5	1,9	4,0	21,0	24,0	8	25
B280618	6	1/8	5,5	5,5	24,3	34,0	14	25
B280614	6	1/4	6,0	6,5	25,5	42,0	17	25
B280818	8	1/8	5,5	5,5	24,8	34,0	14	25
B280814	8	1/4	6,0	6,5	26,5	42,0	17	25
B280838	8	3/8	8,0	7,5	28,0	52,0	20	10
B281014	10	1/4	6,0	6,5	28,4	42,0	17	25
B281038	10	3/8	8,0	7,5	29,9	52,0	20	10
B281238	12	3/8	8,0	7,5	31,4	52,0	20	10

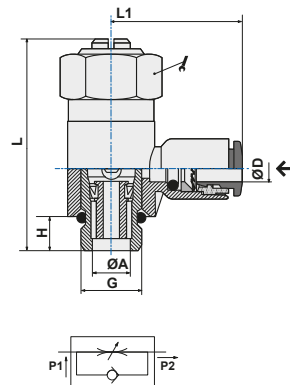

ART. B29

Regolatore di flusso unidirezionale per cilindro
Unidirectional flow regulator for cylinder

CODICE	ØD	G	ØA	H	L1	L		
B2904M5	4	M5	1,9	4,0	19,5	24,0	8	25
B290418	4	1/8	5,0	5,5	21,1	34,0	14	25
B2906M5	6	M5	1,9	4,0	21,0	24,0	8	25
B290618	6	1/8	5,0	5,5	24,3	34,0	14	25
B290614	6	1/4	6,0	6,5	25,5	42,0	17	25
B290818	8	1/8	5,0	5,5	24,8	34,0	14	25
B290814	8	1/4	6,0	6,5	26,5	42,0	17	25
B290838	8	3/8	6,5	7,5	28,0	52,0	20	10
B291014	10	1/4	6,0	6,5	28,4	42,0	17	25
B291038	10	3/8	6,5	7,5	29,9	52,0	20	10
B291238	12	3/8	6,5	7,5	31,4	52,0	20	10
B291212	12	1/2	10,0	9	34,9	61,0	26	10

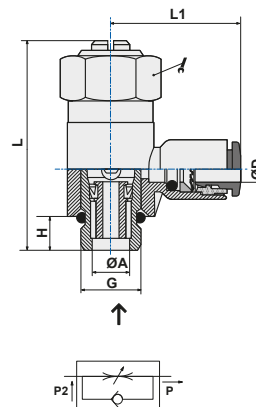

ART. B30

Regolatore di flusso bidirezionale
Bidirectional flow regulator

CODICE	ØD	G	H	L1	L		
B3004M5	4	M5	4,0	19,5	24	8	25
B300418	4	1/8	5,5	21,1	34	14	25
B3006M5	6	M5	4,0	21,0	24	8	25
B300618	6	1/8	5,5	24,3	34	14	25
B300614	6	1/4	6,5	25,5	42	17	25
B300818	8	1/8	5,5	24,8	34	14	25
B300814	8	1/4	6,5	26,5	42	17	25
B300838	8	3/8	7,5	28,0	52	20	10
B301014	10	1/4	6,5	28,4	42	17	25
B301038	10	3/8	7,5	29,9	52	20	10
B301238	12	3/8	7,5	31,4	52	20	10
B301212	12	1/2	9	34,9	61	26	10

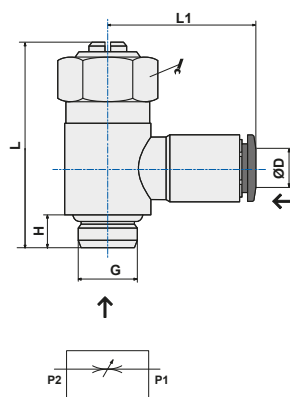

ART. B28P

 Regolatore di flusso per valvola girevole
Swivel flow regulator for valve

CODICE	ØD	G	H	L	L1		
B2804M5P	4	M5	4	19,5	35,0	8	25
B280418P	4	1/8	5,5	43,0	21,1	9	25
B2806M5P	6	M5	4	21,0	35,0	8	25
B280618P	6	1/8	5,5	43,0	24,3	9	25
B280818P	8	1/8	5,5	43,0	24,8	9	25
B280614P	6	1/4	6,5	50,0	25,5	12	25
B280814P	8	1/4	6,5	50,0	26,5	12	25
B281014P	10	1/4	6,5	50,0	28,0	12	25

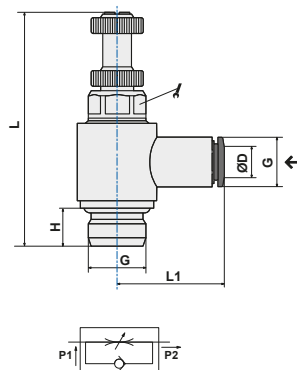
ART. B29P

 Regolatore di flusso per cilindro girevole
Swivel flow regulator for cylinder

CODICE	ØD	G	H	L	L1		
B204M5P	4	M5	4	19,5	35,0	8	25
B290418P	4	1/8	5,5	43,0	21,1	9	25
B2906M5P	6	M5	4	21,0	35,0	8	25
B290618P	6	1/8	5,5	43,0	24,3	9	25
B290818P	8	1/8	5,5	43,0	24,8	9	25
B290614P	6	1/4	6,5	50,0	25,5	12	25
B290814P	8	1/4	6,5	50,0	26,5	12	25
B291014P	10	1/4	6,5	50,0	28,4	12	25

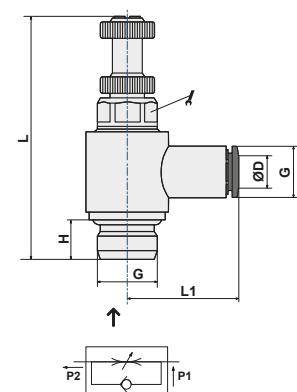
ART. B30P

 Regolatore di flusso bidirezionale
Bidirectional flow regulator

CODICE	ØD	G	H	L	L1		
B3004M5P	4	M5	4	19,5	35,0	8	25
B300418P	4	1/8	5,5	43	21,1	9	25
B3006M5P	6	M5	4	21	35,0	8	25
B300618P	6	1/8	5,5	43	24,3	9	25
B300818P	8	1/8	5,5	43	24,8	9	25
B300614P	6	1/4	6,5	50	25,5	12	25
B300814P	8	1/4	6,5	50	26,5	12	25
B301014P	10	1/4	6,5	50	28,4	12	25

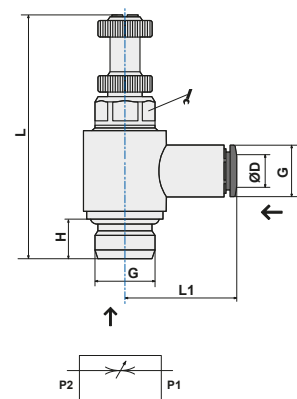

ART. 280T

Regolatore di flusso orientabile per valvola
Orientable flow regulator for valve

CODICE	ØD	G	ØA	H	L1	L		
280T04M5	4	M5	1,9	4,0	19,5	24,0	8	25
280T0418	4	1/8	5,5	5,5	21,1	34,0	14	25
280T06M5	6	M5	1,9	4,0	21,0	24,0	8	25
280T0618	6	1/8	5,5	5,5	24,3	34,0	14	25
280T0614	6	1/4	6,0	6,5	25,5	42,0	17	25
280T0818	8	1/8	5,5	5,5	24,8	34,0	14	25
280T0814	8	1/4	6,0	6,5	26,5	42,0	17	25
280T0838	8	3/8	8,0	7,5	28,0	52,0	20	10
280T1014	10	1/4	6,0	6,5	28,4	42,0	17	25
280T1038	10	3/8	8,0	7,5	29,9	52,0	20	10
280T1238	12	3/8	8,0	7,5	31,4	52,0	20	10

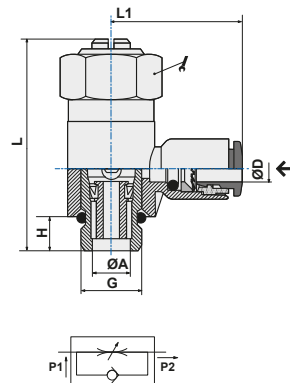

ART. 290T

Regolatore di flusso orientabile per cilindro
Orientable flow regulator for cylinder

CODICE	ØD	G	ØA	H	L1	L		
290T04M5	4	M5	1,9	4,0	19,5	24,0	8	25
290T0418	4	1/8	5,0	5,5	21,1	34,0	14	25
290T06M5	6	M5	1,9	4,0	21,0	24,0	8	25
290T0618	6	1/8	5,0	5,5	24,3	34,0	14	25
290T0614	6	1/4	6,0	6,5	25,5	42,0	17	25
290T0818	8	1/8	5,0	5,5	24,8	34,0	14	25
290T0814	8	1/4	6,0	6,5	26,5	42,0	17	25
290T0838	8	3/8	6,5	7,5	28,0	52,0	20	10
290T1014	10	1/4	6,0	6,5	28,4	42,0	17	25
290T1038	10	3/8	6,5	7,5	29,9	52,0	20	10
290T1238	12	3/8	6,5	7,5	31,4	52,0	20	10
290T1212	12	1/2	10,0	9	34,9	61,0	26	10

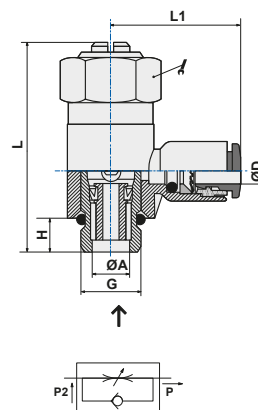

ART. 300T

Regolatore di flusso orientabile bidirezionale
Orientable bidirectional flow regulator

CODICE	ØD	G	H	L1	L		
300T04M5	4	M5	4,0	19,5	24	8	25
300T0418	4	1/8	5,5	21,1	34	14	25
300T06M5	6	M5	4,0	21,0	24	8	25
300T0618	6	1/8	5,5	24,3	34	14	25
300T0614	6	1/4	6,5	25,5	42	17	25
300T0818	8	1/8	5,5	24,8	34	14	25
300T0814	8	1/4	6,5	26,5	42	17	25
300T0838	8	3/8	7,5	28,0	52	20	10
300T1014	10	1/4	6,5	28,4	42	17	25
300T1038	10	3/8	7,5	29,9	52	20	10
300T1238	12	3/8	7,5	31,4	52	20	10
300T1212	12	1/2	9	34,9	61	26	10

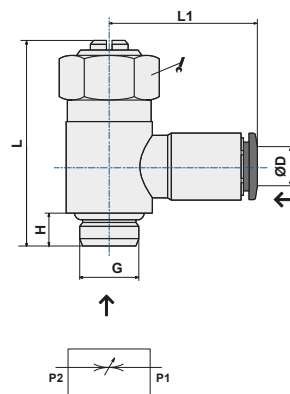

ART. 280P

 Regolatore di flusso girevole per valvola
Swivel flow regulator for valve

CODICE	ØD	G	H	L	L1		
28OT04M5P	4	M5	4	19,5	35,0	8	25
28OT0418P	4	1/8	5,5	43,0	21,1	9	25
28OT06M5P	6	M5	4	21,0	35,0	8	25
28OT0618P	6	1/8	5,5	43,0	24,3	9	25
28OT0818P	8	1/8	5,5	43,0	24,8	9	25
28OT0614P	6	1/4	6,5	50,0	25,5	12	25
28OT0814P	8	1/4	6,5	50,0	26,5	12	25
28OT1014P	10	1/4	6,5	50,0	28,4	12	25

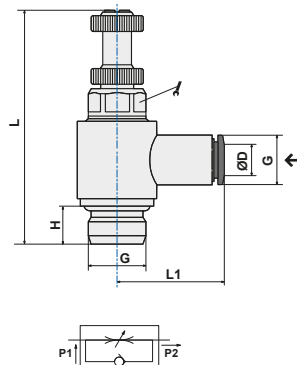
ART. 290P

 Regolatore di flusso girevole per cilindro
Swivel flow regulator for cylinder

CODICE	ØD	G	H	L	L1		
29OT04M5P	4	M5	4	19,5	35,0	8	25
29OT0418P	4	1/8	5,5	43,0	21,1	9	25
29OT06M5P	6	M5	4	21,0	35,0	8	25
29OT0618P	6	1/8	5,5	43,0	24,3	9	25
29OT0818P	8	1/8	5,5	43,0	24,8	9	25
29OT0614P	6	1/4	6,5	50,0	25,5	12	25
29OT0814P	8	1/4	6,5	50,0	26,5	12	25
29OT1014P	10	1/4	6,5	50,0	28,4	12	25

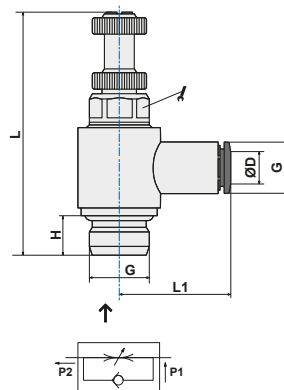
ART. 300P

 Regolatore di flusso girevole bidirezionale
Swivel bidirectional flow regulator

CODICE	ØD	G	H	L	L1		
30OT04M5P	4	M5	4	19,5	35,0	8	25
30OT0418P	4	1/8	5,5	43	21,1	9	25
30OT06M5P	6	M5	4	21	35,0	8	25
30OT0618P	6	1/8	5,5	43	24,3	9	25
30OT0818P	8	1/8	5,5	43	24,8	9	25
30OT0614P	6	1/4	6,5	50	25,5	12	25
30OT0814P	8	1/4	6,5	50	26,5	12	25
30OT1014P	10	1/4	6,5	50	28,4	12	25

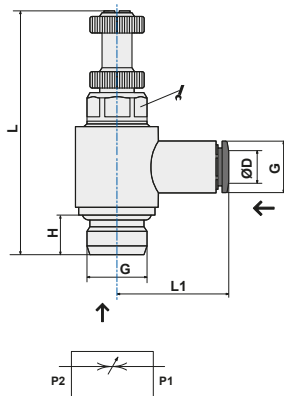

ART. T28

Regolatore di flusso orientabile per valvola
Orientable flow regulator for valve

CODICE	ØD	G	ØA	H	L1	L		
T2804M5	4	M5	2,0	4	19,0	22,5	8	25
T280418	4	1/8	5,0	5,5	21,1	34,0	14	25
T2806M5	6	M5	2,0	4	22,0	22,5	8	25
T280618	6	1/8	5,0	5,5	24,3	34,0	14	25
T280614	6	1/4	6,0	6,5	25,5	42,0	17	25
T280818	8	1/8	5,0	5,5	24,8	34,0	14	25
T280814	8	1/4	6,0	6,5	26,5	42,0	17	25
T280838	8	3/8	6,5	7,5	28,0	52,0	20	10
T281014	10	1/4	6,0	6,5	28,4	42,0	17	25
T281038	10	3/8	6,5	7,5	29,9	52,0	20	10
T281238	12	3/8	6,5	7,5	31,4	52,0	20	10

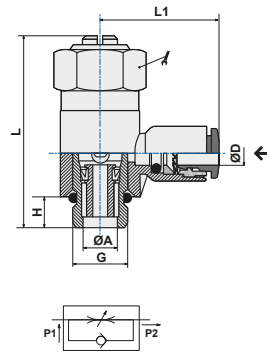

ART. T29

Regolatore di flusso orientabile per cilindro
Orientable flow regulator for cylinder

CODICE	ØD	G	ØA	H	L1	L		
T2904M5	4	M5	2,0	4	19,0	22,5	8	25
T290418	4	1/8	5,0	4	21,1	34,0	14	25
T2906M5	6	M5	2,0	4	22,0	22,5	8	25
T290618	6	1/8	5,0	5,5	24,3	34,0	14	25
T290614	6	1/4	6,0	6,5	25,5	42,0	17	25
T290818	8	1/8	5,0	5,5	24,8	34,0	14	25
T290814	8	1/4	6,0	6,5	26,5	42,0	17	25
T290838	8	3/8	6,5	7,5	28,0	52,0	20	10
T291014	10	1/4	6,0	6,5	28,4	42,0	17	25
T291038	10	3/8	6,5	7,5	29,9	52,0	20	10
T291012	10	1/2	10,0	9	30,0	61,0	26	10
T291238	12	3/8	6,5	7,5	31,4	52,0	20	10
T291212	12	1/2	10,0	9	34,9	61,0	26	10

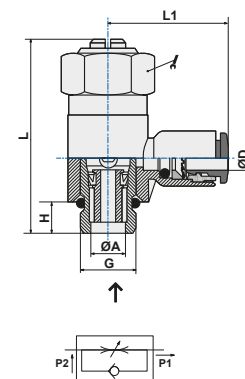

ART. T30

Regolatore di flusso orientabile bidirezionale
Orientable bidirectional flow regulator

CODICE	ØD	G	ØA	H	L1	L		
T3004M5	4	M5	2,0	4	19,0	22,5	8	25
T300418	4	1/8	5,0	4	21,1	34,0	14	25
T3006M5	6	M5	2,0	4	22,0	22,5	8	5
T300618	6	1/8	5,0	5,5	24,3	34,0	14	25
T300614	6	1/4	6,0	6,5	25,5	42,0	17	25
T300818	8	1/8	5,0	5,5	24,8	34,0	14	25
T300814	8	1/4	6,0	6,5	26,5	42,0	17	25
T300838	8	3/8	6,5	7,5	28,0	52,0	20	10
T301014	10	1/4	6,0	6,5	28,4	42,0	17	25
T301038	10	3/8	6,5	7,5	29,9	52,0	20	10
T301238	12	3/8	6,5	7,5	31,4	52,0	20	10
T301212	12	1/2	10,0	9	34,9	61,0	26	10

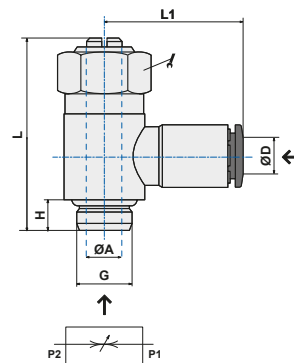

ART. T28P

 Regolatore di flusso girevole per valvola
Swivel flow regulator for valve

CODICE	ØD	G	B	L	L1			
T2804M5P	4	M5	4	34	19,0			
T280418P	4	1/8	5,5	43	21,1			
T2806M5P	6	M5	4	34	22,0			
T280618P	6	1/8	5,5	43	24,3			
T280614P	6	1/4	6,5	50	25,5			
T280638P*	6	3/8	9,5	53	29,5			
T280612P	6	1/2	12,0	61	30,2			
T280818P	8	1/8	5,5	43	24,8			
T280814P	8	1/4	6,5	50	26,5			
T280838P*	8	3/8	9,5	53	30,0			
T280812P*	8	1/2	1,2	61	35,8			
T281018P*	10	1/8	6,5	42	30,7			
T281014P	10	1/4	6,5	50	28,4			
T281038P*	10	3/8	9,5	53	33,5			
T281012P*	10	1/2	12,0	61	36,5			
T281214P*	12	1/4	8,5	48	33,7			
T281238P*	12	3/8	9,5	53	35,5			
T281212P*	12	1/2	12,0	61	36,5			

* = di importazione - imported

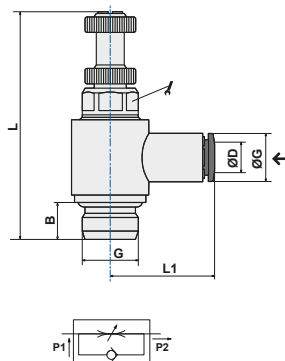
ART. T29P

 Regolatore di flusso girevole per cilindro
Swivel flow regulator for cylinder

CODICE	ØD	G	B	L	L1			
T2904M5P	4	M5	4	34	15,0			
T290418P	4	1/8	5,5	43	21,1			
T290414P*	4	1/4	6,5	50	25,5			
T2906M5P	6	M5	4	34	22,0			
T290618P	6	1/8	5,5	43	24,3			
T290614P	6	1/4	6,5	50	25,5			
T290638P*	6	3/8	9,5	53	29,5			
T290612P*	6	1/2	12,0	61	30,2			
T290818P	8	1/8	5,5	43	24,8			
T290814P	8	1/4	6,5	50	26,5			
T290838P*	8	3/8	9,5	53	30,0			
T290812P*	8	1/2	1,2	61	35,8			
T291018P*	10	1/8	6,5	42	30,7			
T291014P	10	1/4	6,5	50	28,4			
T291038P*	10	3/8	9,5	53	33,5			
T291012P*	10	1/2	12,0	61	36,5			
T291214P*	12	1/4	8,5	48	33,7			
T291238P*	12	3/8	9,5	53	35,5			
T291212P*	12	1/2	12,0	61	36,5			

* = di importazione - imported

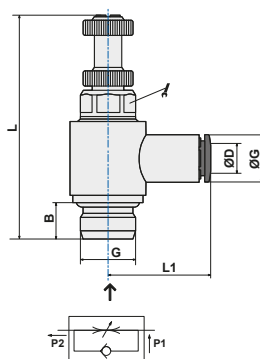

ART. T30P

Regolatore di flusso girevole bidirezionale
Swivel bidirectional flow regulator

CODICE	ØD	G	B	L	L1		
T3004M5P	4	M5	4	34	19,0	8	25
T300418P	4	1/8	5,5	43	21,1	9	25
T3006M5P	6	M5	4	34	22,0	8	25
T300618P	6	1/8	5,5	43	24,3	9	25
T300614P	6	1/4	6,5	50	25,5	12	25
T300818P	8	1/8	5,5	43	24,8	9	25
T300814P	8	1/4	6,5	50	26,5	12	25
T301014P	10	1/4	6,5	50	28,4	12	25

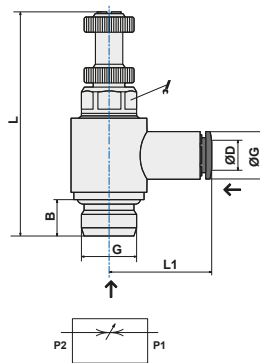

ART. T31

Regolatore di flusso in linea
Flat flow regulator

CODICE	ØD	B	G	F	S	Ød	J
T310400	4	40,5	14,4	6,5	6,5	3,2	14
T310600	6	48,7	25,3	8,5	11,0	4,3	20
T310800	8	54,4	25,1	9,5	12,0	4,3	22
T311000	10	64,3	28,8	10,5	12,5	4,3	26
T311200	12	74,6	26,1	13,0	16,0	4,3	32

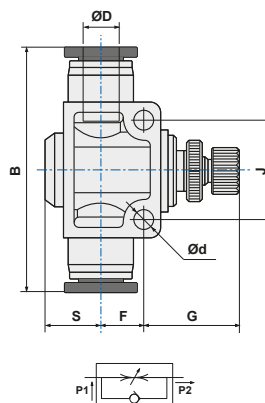

NOTA: articolo di importazione - NOTE: imported item

ART. TB28

 Regolatore di flusso orientabile per valvola
Orientable flow regulator for valve

CODICE	ØD	G	ØA	H	L1	L		
TB2804M5	4	M5	2,0	4	19,0	22,5	8	25
TB280418	4	1/8	5,0	5,5	21,1	34,0	14	25
TB2806M5	6	M5	2,0	4	22,0	22,5	8	25
TB280618	6	1/8	5,0	5,5	24,3	34,0	14	25
TB280614	6	1/4	6,0	6,5	25,5	42,0	17	25
TB280818	8	1/8	5,0	5,5	24,8	34,0	14	25
TB280814	8	1/4	6,0	6,5	26,5	42,0	17	25
TB280838	8	3/8	6,5	7,5	28,0	52,0	20	10
TB281014	10	1/4	6,0	6,5	28,4	42,0	17	25
TB281038	10	3/8	6,5	7,5	29,9	52,0	20	10
TB281238	12	3/8	6,5	7,5	31,4	52,0	20	10

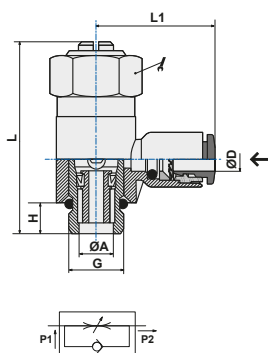
ART. TB29

 Regolatore di flusso orientabile per cilindro
Orientable flow regulator for cylinder

CODICE	ØD	G	ØA	H	L1	L		
TB2904M5	4	M5	2,0	4	19,0	22,5	8	25
TB290418	4	1/8	5,0	4	21,1	34,0	14	25
TB2906M5	6	M5	2,0	4	22,0	22,5	8	25
TB290618	6	1/8	5,0	5,5	24,3	34,0	14	25
TB290614	6	1/4	6,0	6,5	25,5	42,0	17	25
TB290818	8	1/8	5,0	5,5	24,8	34,0	14	25
TB290814	8	1/4	6,0	6,5	26,5	42,0	17	25
TB290838	8	3/8	6,5	7,5	28,0	52,0	20	10
TB291014	10	1/4	6,0	6,5	28,4	42,0	17	25
TB291038	10	3/8	6,5	7,5	29,9	52,0	20	10
TB291012	10	1/2	10,0	9	30,0	61,0	26	10
TB291238	12	3/8	6,5	7,5	31,4	52,0	20	10
TB291212	12	1/2	10,0	9	34,9	61,0	26	10

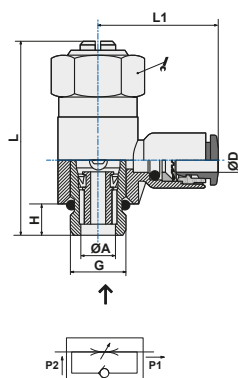
ART. TB30

 Regolatore di flusso orientabile bidirezionale
Orientable bidirectional flow regulator

CODICE	ØD	G	ØA	H	L1	L		
TB3004M5	4	M5	2,0	4	19,0	22,5	8	25
TB300418	4	1/8	5,0	4	21,1	34,0	14	25
TB3006M5	6	M5	2,0	4	22,0	22,5	8	5
TB300618	6	1/8	5,0	5,5	24,3	34,0	14	25
TB300614	6	1/4	6,0	6,5	25,5	42,0	17	25
TB300818	8	1/8	5,0	5,5	24,8	34,0	14	25
TB300814	8	1/4	6,0	6,5	26,5	42,0	17	25
TB300838	8	3/8	6,5	7,5	28,0	52,0	20	10
TB301014	10	1/4	6,0	6,5	28,4	42,0	17	25
TB301038	10	3/8	6,5	7,5	29,9	52,0	20	10
TB301238	12	3/8	6,5	7,5	31,4	52,0	20	10
TB301212	12	1/2	10,0	9	34,9	61,0	26	10

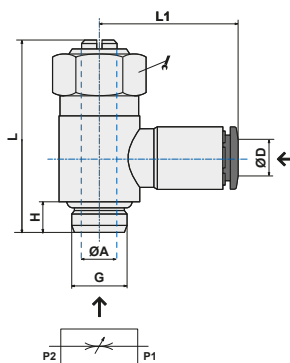

ART. TB28P

Regolatore di flusso girevole per valvola
Swivel flow regulator for valve

CODICE	ØD	G	B	L	L1			
TB2804M5P	4	M5	4	34	19,0		8,0	25
TB280418P	4	1/8	5,5	43	21,1		9,0	25
TB2806M5P	6	M5	4	34	22,0		8,0	25
TB280618P	6	1/8	5,5	43	24,3		9,0	25
TB280614P	6	1/4	6,5	50	25,5		12,0	25
TB280638P*	6	3/8	9,5	53	29,5		13,0	10
TB280612P	6	1/2	12,0	61	30,2		13,0	10
TB280818P	8	1/8	5,5	43	24,8		9,0	25
TB280814P	8	1/4	6,5	50	26,5		12,0	25
TB280838P*	8	3/8	9,5	53	30,0		14,4	10
TB280812P*	8	1/2	1,2	61	35,8		14,4	10
TB281018P*	10	1/8	6,5	42	30,7		18,4	10
TB281014P	10	1/4	6,5	50	28,4		12,0	25
TB281038P*	10	3/8	9,5	53	33,5		18,4	10
TB281012P*	10	1/2	12,0	61	36,5		18,4	10
TB281214P*	12	1/4	8,5	48	33,7		21,0	10
TB281238P*	12	3/8	9,5	53	35,5		19,0	10
TB281212P*	12	1/2	12,0	61	36,5		21,0	10

* = di importazione - imported

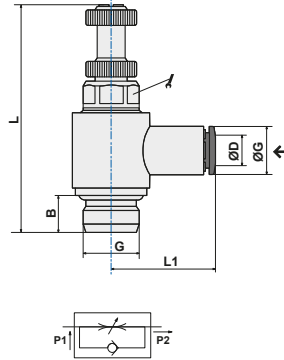

ART. TB29P

Regolatore di flusso girevole per cilindro
Swivel flow regulator for cylinder

CODICE	ØD	G	B	L	L1			
TB2904M5P	4	M5	4	34	15,0		8,0	25
TB290418P	4	1/8	5,5	43	21,1		9,0	25
TB290414P*	4	1/4	6,5	50	25,5		12,0	25
TB2906M5P	6	M5	4	34	22,0		8,0	25
TB290618P	6	1/8	5,5	43	24,3		9,0	25
TB290614P	6	1/4	6,5	50	25,5		12,0	25
TB290638P*	6	3/8	9,5	53	29,5		13,0	10
TB290612P*	6	1/2	12,0	61	30,2		13,0	10
TB290818P	8	1/8	5,5	43	24,8		9,0	25
TB290814P	8	1/4	6,5	50	26,5		12,0	25
TB290838P*	8	3/8	9,5	53	30,0		14,4	10
TB290812P*	8	1/2	1,2	61	35,8		14,4	10
TB291018P*	10	1/8	6,5	42	30,7		18,4	10
TB291014P	10	1/4	6,5	50	28,4		12,0	25
TB291038P*	10	3/8	9,5	53	33,5		18,4	10
TB291012P*	10	1/2	12,0	61	36,5		18,4	10
T2B91214P*	12	1/4	8,5	48	33,7		21,0	10
TB291238P*	12	3/8	9,5	53	35,5		19,0	10
TB291212P*	12	1/2	12,0	61	36,5		21,0	10

* = di importazione - imported

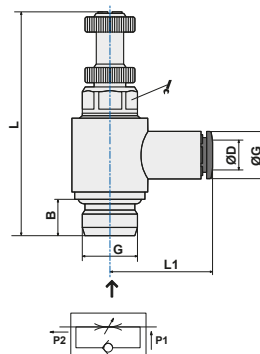

ART. TB30P

Regolatore di flusso girevole bidirezionale
Swivel bidirectional flow regulator

CODICE	ØD	G	B	L	L1			
TB3004M5P	4	M5	4	34	19,0		8	25
TB300418P	4	1/8	5,5	43	21,1		9	25
TB3006M5P	6	M5	4	34	22,0		8	25
TB300618P	6	1/8	5,5	43	24,3		9	25
TB300614P	6	1/4	6,5	50	25,5		12	25
TB300818P	8	1/8	5,5	43	24,8		9	25
TB300814P	8	1/4	6,5	50	26,5		12	25
TB301014P	10	1/4	6,5	50	28,4		12	25

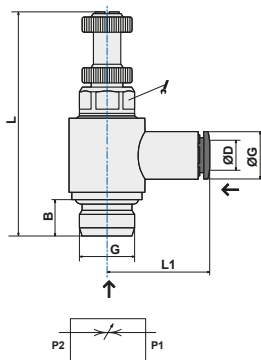

ART. TB31

Regolatore di flusso in linea
Flat flow regulator

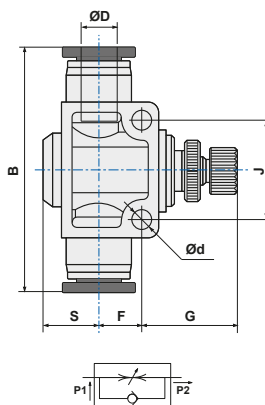

CODICE	ØD	B	G	F	S	Ød	J	
TB310400	4	40,5	14,4	6,5	6,5	3,2	14	25
TB310600	6	48,7	25,3	8,5	11,0	4,3	20	25
TB310800	8	54,4	25,1	9,5	12,0	4,3	22	25
TB311000	10	64,3	28,8	10,5	12,5	4,3	26	10
TB311200	12	74,6	26,1	13,0	16,0	4,3	32	10



NOTA: articolo di importazione - NOTE: imported item

ART. 28/29/30A

Asta regolatore orientabile
Positioned flow regulator stem

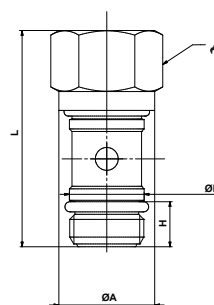

CODICE	L	ØB	H	G	ØA		
28/29/30AM5 (*)	24,0	6,0	4,0	M5	5,0	8,0	10
28/29/30A18	31,5	9,8	7,0	1/8	13,5	14,0	10
28/29/30A14	38,0	13,0	8,0	1/4	17,0	17,0	10
28/29/30A38	46,5	16,5	9,0	3/8	21,0	21,0	10
29A12 / 30A12	53,0	20,5	10	1/2	26	26	5

(*) Nota: 13R/T13R



ART. 28/29/30AP

Asta regolatore girevole
Swivel flow regulator stem

CODICE	L max	ØB	H	G	ØA		
28/29/30AM5P (*)	35,0	6,0	4,2	M5	5,0	8,0	10
28/29/30A18P	37,5	9,8	5,9	1/8	13,5	9,0	10
28/29/30A14P	44,0	13,0	7,0	1/4	17,0	12,0	10

(*) Nota: 13R/T13R

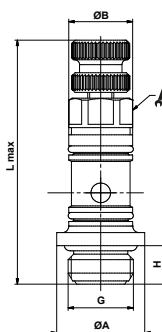

28 = per valvola (IN type) 29 = per cilindro (OUT type) 30 = bidirezionale (bi-directional)

ART. T29GS

Regolatore di flusso per cilindro con ghiera di blocco
Speed controller for cylinders with lock cap

CODICE	ØD	G	L1	L2	L3	L4	ØD1	
T29GS04M5	4	M5	3,5	18,0	28,0	18,0	9,5	9
T29GS0418	4	G1/8	5,5	21,5	33,5	24,0	13,0	13
T29GS06M5	6	M5	3,5	17,6	28,0	19,0	11,5	9
T29GS0618	6	G1/8	5,5	21,5	33,5	22,3	13,0	13
T29GS0614	6	G1/4	7,5	24,5	38,7	24,0	13,0	17
T29GS0818	8	G1/8	5,5	21,5	33,5	25,5	14,5	13
T29GS0814	8	G1/4	7,5	24,5	38,7	27,0	14,5	17

Di importazione
Imported

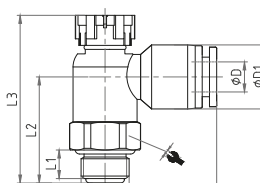

INFORMAZIONI TECNICHE AGGIUNTIVE

Prove di portata

Prova effettuata presso il laboratorio Pneumax su alcuni campioni di regolatori di flusso alle seguenti condizioni:

Fluido	aria filtrata
Temperatura	20°C
Pressione	6 bar

ADDITIONAL TECHNICAL INFORMATION

Flow tests

Test carried out at the Pneumax laboratory on a flow regulators sample under the following conditions:

Fluid	filtered air
Temperature	20°C
Pressure	6 bar

Risultati della prova • Tests results

N° giri spillo Needle turns	Portata • Flow (ltr/min)						
	T290618	T290618P	T290614	T290614P	T290838	T290838P	T291012P
0,0	0	0	0	0	0	0	0
0,5	5	5	38	2	40	21	30
1,0	10	10	48	23	92	40	63
1,5	20	16	55	41	139	59	94
2,0	23	22	65	50	185	78	123
2,5	27	25	72	58	230	96	156
3,0	30	28	80	64	272	115	186
3,5	34	33	88	73	318	135	220
4,0	37	43	100	81	361	153	251
4,5	40	55	121	97	405	171	282
5,0	44	68	145	118	447	190	312
5,5	52	80	170	142	489	207	343
6,0	64	93	196	169	530	224	375
6,5	75	105	220	193	580	240	404
7,0	88	118	241	217	664	251	437
7,5	101	127	260	238	811	276	466
8,0	113	172	277	255	963	392	480
8,5	126	240	294	273	1075	530	485
9,0	136	283	325	300	1154	635	543
9,5	158	300	355	334	1200	700	635
10,0	191		383	364	1228	750	845
10,5	195		408	379	1235	778	1083
11,0			421	400		802	1288
11,5			427	407		814	1454
12,0			432	414		824	1588
12,5			434	417		833	1685
13,0			436	418		835	1754
13,5							1795
14,0							1820
14,5							
15,0							

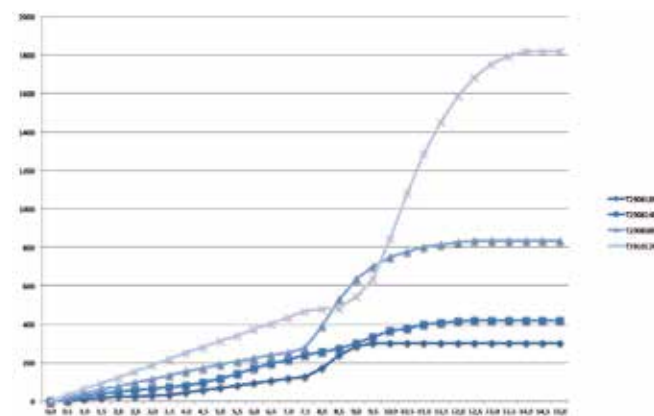
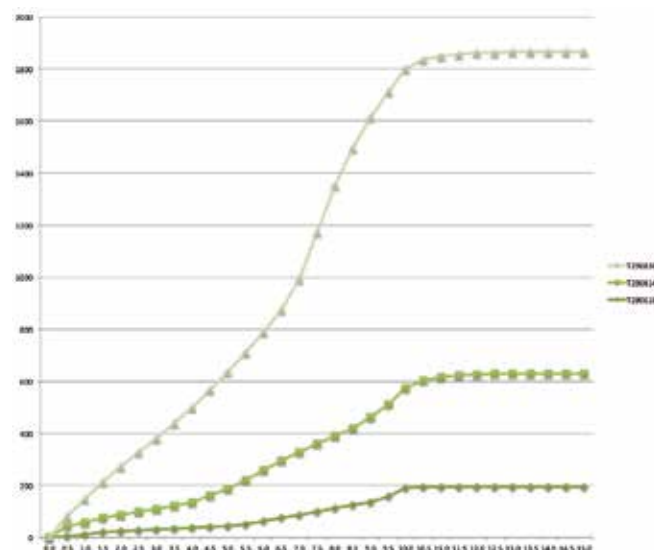

Risultati della prova • Tests results

N° giri spillo Needle turns	Portata • Flow (ltr/min)							
	T280618	T280618P	T280614	T280838P	T281212P	T290838-V	T290838-B	T290838-C
0,0	0	0	0	0	0	0	0	0
0,5	0	0	20	22	35	42	39	88
1,0	6	10	24	40	70	82	79	185
1,5	12	13	34	59	100	124	122	280
2,0	14	16	43	78	138	159	163	375
2,5	17	20	48	100	171	200	205	480
3,0	20	22	57	120	207	236	244	582
3,5	22	25	65	141	240	272	282	680
4,0	24	32	80	160	274	307	320	780
4,5	27	44	98	184	306	342	357	880
5,0	34	55	115	207	338	377	392	1110
5,5	44	69	142	226	370	411	425	1428
6,0	53	81	162	255	402	445	460	1628
6,5	64	94	182	360	433	478	496	1720
7,0	74	106	202	498	464	529	546	1767
7,5	84	120	221	614	494	640	642	1798
8,0	95	155	247	712	525	800	793	1820
8,5	125	207	294	778	560	970	983	1825
9,0	184	250	365	808	678	1088	1129	
9,5	185	269	442	823	877	1145	1222	
10,0		275	495	830	1079	1185		
10,5			528	835	1280	1187		
11,0			541	838	1340			
11,5			549	843	1623			
12,0			552		1760			
12,5			553		1880			
13,0					1970			
13,5					2055			
14,0					2060			
14,5								
15,0								

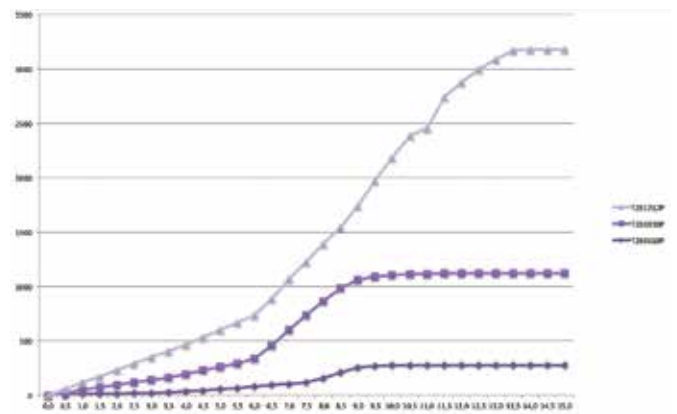
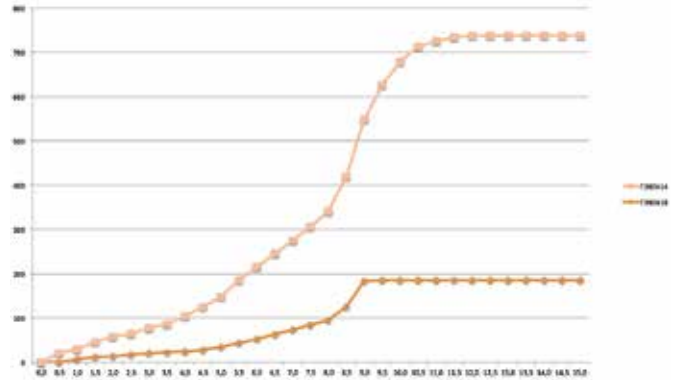

Codice regolatore Regulator code	Portata • Flow (ltr/min)	
	6 bar Δp=1 Nominale 6 bar Δp=1 Nominal	6 bar max Scarico libero 6 bar max Free exhaust
T280618	120	185
T280618P	170	280
T280614	320	550
T280838P	505	840
T281212P	1230	2060
T290618	120	195
T290618P	175	300
T290614	260	435
T290614P	245	420
T290838	790	1235
T290838P	525	835
T291012P	1120	1820
T300618	200	330
T301014	365	655
T290838-V	705	1185
T290838-B	775	1070
T291212-C	1160	1825

Aste G1/8" anello tubo 4 Stems G1/8" banjo diam. 4	1	2	3	4	5	m/a	um
Serraggio OK • Clamping OK	2,5	2,5	2,5	2,5		2,5	Nm
Anello schiacciato • Ring crushed	3,5	3,5	3,0	3,3		3,5	Nm
Anello deformato • Deformed ring	5,0	5,5	4,5	5,0		5,0	Nm
Rottura asta • Stem breakage	16,4	16,4	15,3	14,5		16,0	Nm
Aste G1/4" anello tubo 6 Stems G1/4" banjo diam. 6	1	2	3	4	5	m/a	um
Serraggio OK • Clamping OK	2,5	3,0	2,5	2,5	3,0	3,0	Nm
Anello schiacciato • Ring crushed	4,0	5,0	5,5	6,0	6,0	5,5	Nm
Anello deformato • Deformed ring	7,0	7,5	8,0	8,5	9,0	8,0	Nm
Rottura asta • Stem breakage	33,0	32,1	30,1	32,4	33,4	32,0	Nm
Aste G3/8" anello tubo 8 Stems G3/8" banjo diam. 8	1	2	3	4	5	m/a	um
Serraggio OK • Clamping OK	4,0	5,0				4,5	Nm
Anello schiacciato • Ring crushed	8,0	8,5				8,0	Nm
Anello deformato • Deformed ring	15,0	16,0				16,0	Nm
Rottura asta • Stem breakage	41,9	44,3				43,0	Nm

BREVE DESCRIZIONE

I Regolatori di flusso della nostra serie RAP e TRAP sono realizzati in Italia, a garanzia di elevati standard di qualità secondo le normative ISO di riferimento, e rispondono alle seguenti specifiche tecniche e applicative.

SHORT DESCRIPTION

The RAP and TRAP Speed controllers series are produced in Italy according to the reference ISO norms as warranty of high quality level and answer to the followings technical specifications and applications.

SCHEMA TECNICA TECHNICAL SHEET

FLUIDI UTILIZZABILI <i>EMPLOYABLE FLUIDS</i>		Aria compressa (per altri fluidi contattare il nostro Ufficio Tecnico) <i>Compressed air (for different fluid pls contact our Technical Dept.)</i>
APPLICAZIONI <i>APPLICATIONS</i>		Pneumatica, idraulica a bassa pressione, secondo normativa DIN 3861-3870. <i>Pneumatic circuits, low pressure hydraulic applications, according to DIN 3861-3870 norms.</i>
TUBI CONSIGLIATI <i>SUGGESTED TUBES</i>		TPU (Poliuretano), PA11/PA12 (Poliammide), TPE (Polietilene), TCO (Copoliestere) <i>TPU (Polyurethane), PA11/PA12 (Polyamide), TPE (Polyethylene), TCO (Copolyester)</i>
TOLLERANZE TUBI <i>TUBES TOLERANCES</i>		Diam. da 4 a 10 mm +/- 0,05 Diam. da 12 mm +/- 0,1 <i>Diam. between 4 and 10 mm +/- 0,05 Diam. from 12 mm +/- 0,1</i>
TEMPERATURE E PRESSIONI <i>TEMPERATURE AND PRESSURE</i>	VALORI LIMITE CONSIGLIATI <i>RECOMMENDED LIMIT VALUES</i>	Le temperature e le pressioni dipendono generalmente dalle caratteristiche del tubo impiegato, e comunque si suggerisce di non superare i 15 bar e temperature comprese fra -20°C e +70°C. <i>Temperatures and pressures usually depend by the technical features of the employed tubes, anyway it is suggested a limit working pressure of 15 bar and a temperature range between -20°C and +70°C</i>
	DATI TECNICI DI PROVA <i>TECHNICAL TESTING DATA</i>	A pagg. 34 e 64 sono riportati i dati di resistenza a trazione e i valori limite di utilizzo (Pressione e Temperature) relativi ai principali tubi commerciali. <i>At pages 34 and 64 are indicated the load traction resistance values and the main working and breaking limit (Pressure and Temperature) of the main commercial tubing.</i>
	NOTA <i>NOTE</i>	Per dati più puntuali consultare il catalogo tecnico del proprio fornitore di tubi. <i>For more complete informations pls read the technical catalogue of your tube supplier.</i>
FILETTATURE <i>THREAD TYPE</i>		BSP cilindrica UNI-ISO 228 <i>BSP parallell UNI-ISO 228</i>
MATERIALI <i>MATERIALS</i>	corpo RAP, colonnina di regolazione, Spintore "OT" <i>RAP body, regulation stem, "OT" sleeve</i>	Ottone UNI EN 12164 CW614N <i>Brass UNI EN 12164 CW614N</i>
	corpo TRAP, spintore, distanziale, sottomolla <i>TRAP body, sleeve, collar and back ring</i>	POM copolimero ISO1043-1 <i>POM copolymer ISO1043-1</i>
	pinza <i>spring</i>	Acciaio Inox AISI 301 austenitico <i>Stainless steel AISI 301 austenitic</i>
	guarnizioni tenuta <i>seals</i>	NBR 70 DWGV-EN549 UL157 <i>NBR 70 DWGV-EN549 UL157</i>

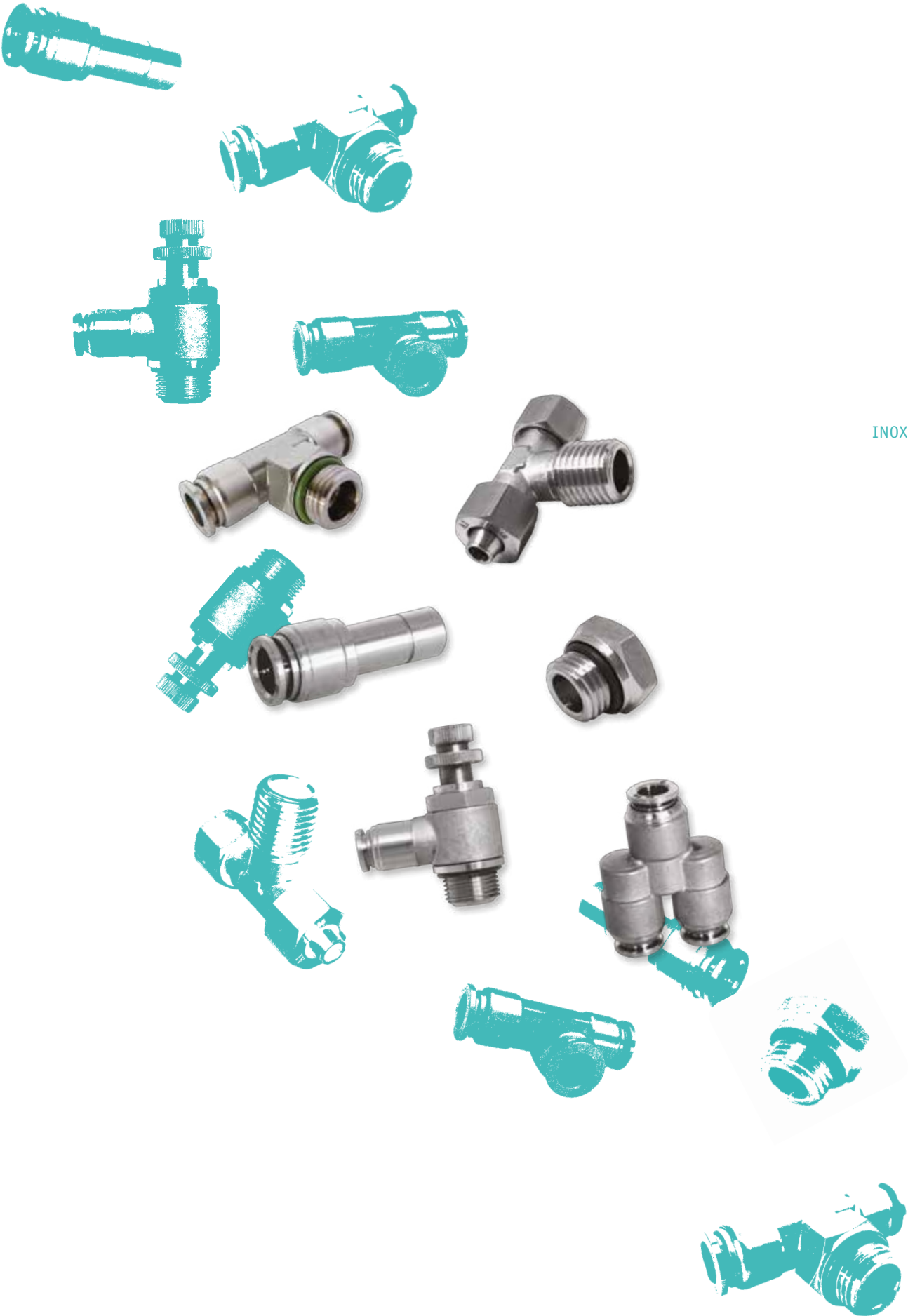

INOX SS

- 1 ANELLO SPINGITORE
THRUST SLEEVE
- 2 DISTANZIALE DI FERMO
LOCK RING
- 3 PINZA DI AGGRAFFAGGIO
CRIMPING GRIPPER
- 4 ANELLO DI SOSTEGNO
SUPPORTING RING
- 5 GUARNIZIONE DI TENUTA
SEAL PACKING
- 6 CORPO DEL RACCORDO
FITTING BODY
- 7 O-RING DI TENUTA
O-RING SEAL

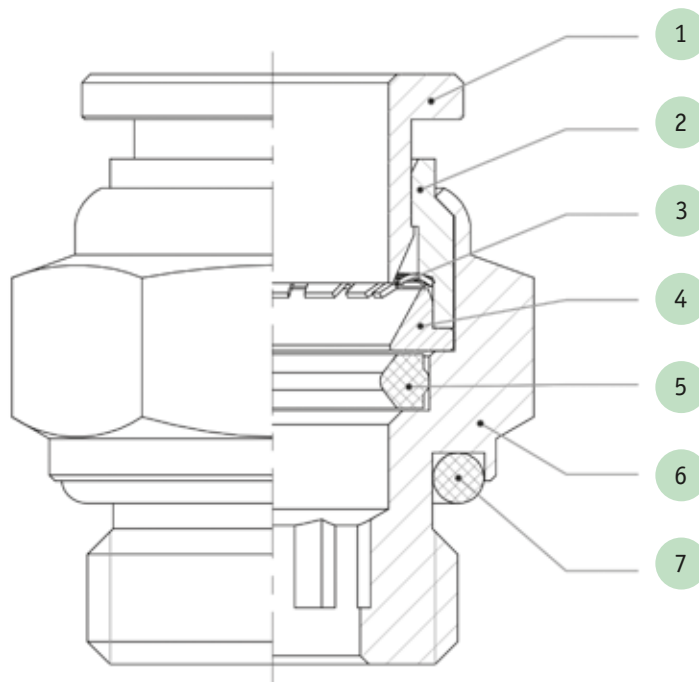

ART. SSC-G

Diritto filetto a maschio
Straight male parallel adaptor

CODICE	ØD	G	L1	L2	⊙	🔑	🏭
SSC04-M5	4	M5	4	19,3	2	10	10
SSC04-G01	4	1/8	5,5	17,3	3	13	10
SSC04-G02	4	1/4	6,5	21,2	3	17	10
SSC06-M5	6	M5	4	20,6	2	12	10
SSC06-G01	6	1/8	5,5	18,8	4	13	10
SSC06-G02	6	1/4	6,5	18,8	4	16	10
SSC08-G01	8	1/8	5,5	23,2	5	14	10
SSC08-G02	8	1/4	6,5	20,7	6	16	10
SSC08-G03	8	3/8	7,5	22,5	6	21	10
SSC10-G02	10	1/4	6,5	26,4	8	17	10
SSC10-G03	10	3/8	7,5	22,9	8	20	5
SSC10-G04	10	1/2	9,0	24	8	24	5
SSC12-G02	12	1/4	6,5	31,3	8	21	5
SSC12-G03	12	3/8	7,5	25,4	10	20	5
SSC12-G04	12	1/2	9	25,4	10	24	5
SSC14-G03	14	3/8	7,5	33	10	22	5
SSC14-G04	14	1/2	9,0	32	10	24	5

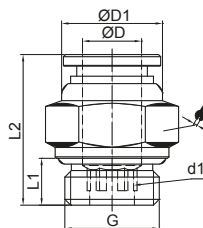

ART. SSC

Diritto filetto conico maschio
Straight male tapered adaptor

CODICE	ØD	R	L1	L2	⊙	🔑	🏭
SSC04-01	4	1/8	7,5	16,8	3	10	10
SSC04-02	4	1/4	9,5	21	3	14	10
SSC06-01	6	1/8	7,5	19,3	4	12	10
SSC06-02	6	1/4	9,5	19,8	4	14	10
SSC06-03	6	3/8	10,5	22	4	17	10
SSC06-04	6	1/2	12,5	24	4	21	10
SSC08-01	8	1/8	7,5	23,7	6	14	10
SSC08-02	8	1/4	9,5	22,2	6	14	10
SSC08-03	8	3/8	10,5	22,5	6	17	10
SSC08-04	8	1/2	12,5	24	6	21	10
SSC10-02	10	1/4	9,5	26,4	8	17	10
SSC10-03	10	3/8	10,5	22,9	8	17	5
SSC10-04	10	1/2	12,5	25	8	21	5
SSC12-02	12	1/4	9,5	31,3	8	21	5
SSC12-03	12	3/8	10,5	26,4	10	20	5
SSC12-04	12	1/2	13,5	26,4	10	21	5
SSC14-04	14	1/2	12,5	33	10	22	5

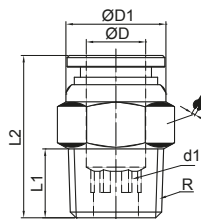

ART. SSCF-G

 Diritto femmina (filetto cilindrico)
 Straight female adaptor (parallel thread)

CODICE	ØD	G	L1	L2		
SSCF04-M5	4	M5	20,2	10,5	12	10
SSCF04-01	4	1/8	21,2	10,5	12	10
SSCF04-02	4	1/4	21	10,5	17	10
SSCF06-01	6	1/8	21,6	12,5	14	10
SSCF06-02	6	1/4	21	12,5	17	10
SSCF08-01	8	1/8	25	14,5	17	10
SSCF08-02	8	1/4	24,5	14,5	17	10

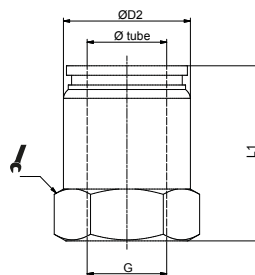
ART. SSH

 Anello semplice girevole con asta conico
 Complete single banjo tapered

CODICE	ØD	R	L1	L2	D2	
SSH04-01	4	1/8	25,5	26	10,5	10
SSH06-01	6	1/8	25,5	26	12,5	10
SSH06-02	6	1/4	28	28	12,5	10
SSH08-01	8	1/8	25,5	29	14,5	10
SSH08-02	8	1/4	28	30	14,5	10
SSH08-03	8	3/8	33,2	33	14,5	10
SSH10-02	10	1/4	28	32	17,5	10
SSH10-03	10	3/8	33,2	35	17,5	10
SSH12-02	12	1/4	28	34	20,5	10
SSH12-03	12	3/8	33,2	36,5	20,5	10
SSH12-04	12	1/2	37,2	38	20,5	10

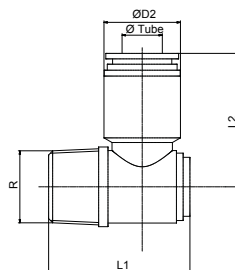
ART. SSL-G

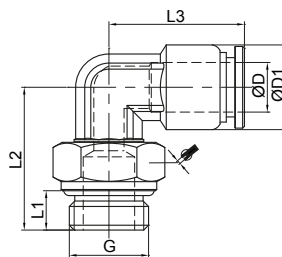

 Gomito girevole filetto cilindrico maschio
 Swivel L male parallel adaptor

CODICE	ØD	G	L1	L2	L3	ØD1		
SSL04-M5	4	M5	4	17,5	18,3	10	10	10
SSL04-G01	4	1/8	5,5	20	18,3	10	13	10
SSL04-G02	4	1/4	6,5	27,5	23	10,5	14	10
SSL06-M5	6	M5	4	17,5	20,3	12	10	10
SSL06-G01	6	1/8	5,5	22	20,3	12	13	10
SSL06-G02	6	1/4	6,5	23	20,3	12	16	10
SSL06-G03	6	3/8	7,5	28	24	12,5	17	10
SSL08-G01	8	1/8	5,5	22,5	22,3	14	13	10
SSL08-G02	8	1/4	6,5	23,5	22,3	14	16	5
SSL08-G03	8	3/8	7,5	28	27	14,5	17	5
SSL10-G01	10	1/8	5,5	32,3	30,5	17,5	17	5
SSL10-G02	10	1/4	6,5	31	26,4	17	17	5
SSL10-G03	10	3/8	7,5	28,5	26,4	17	20	5
SSL10-G04	10	1/2	9	31	30,5	17,5	21	5
SSL12-G02	12	1/4	6,5	30,5	34	20,5	14	5
SSL12-G03	12	3/8	7,5	30	29,4	20	20	5
SSL12-G04	12	1/2	9	30,5	29,4	20	24	5
SSL14-G03	14	3/8	7,5	33	37	22	17	5
SSL14-G04	12	1/2	9	35	37	22	21	5



ART. SSL

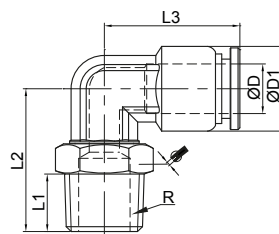

Gomito girevole filetto conico maschio
Swivel L tapered adaptor

CODICE	ØD	R	L1	L2	L3	ØD1		
SSL04-01	4	1/8	7,5	20	18,3	10	12	10
SSL04-02	4	1/4	9,5	27,5	23	10,5	14	10
SSL06-01	6	1/8	7,5	23	20,3	12	12	10
SSL06-02	6	1/4	9,5	23	20,3	12	14	10
SSL06-03	6	3/8	10,5	28	24	12,5	17	10
SSL08-01	8	1/8	7,5	23,5	22,3	14	12	10
SSL08-02	8	1/4	9,5	23,5	22,3	14	14	5
SSL08-03	8	3/8	10,5	28	27	14,5	17	10
SSL10-02	10	1/4	9,5	33	26,4	17	17	5
SSL10-03	10	3/8	10,5	30	26,4	17	17	5
SSL12-02	12	1/4	9,5	30,5	34	20,5	14	5
SSL12-03	12	3/8	10,5	31,5	29,4	20	17	5
SSL12-04	12	1/2	13,5	33,5	29,4	20	21	5



ART. SSLF

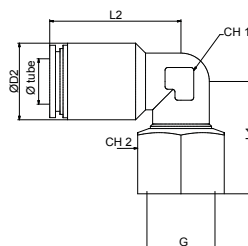

Gomito girevole femmina (filetto cilindrico)
Female swivel L adaptor (parallel thread)

CODICE	ØD	G	L1	L2	D2			
SSLF04-01	4	1/8	25,5	23	10,5	9,2	10	10
SSLF06-01	6	1/8	27	24	12,5	9,2	14	10
SSLF06-02	6	1/4	28	24	12,5	9,2	17	10
SSLF08-01	8	1/8	27	27	14,5	11,2	14	10
SSLF08-02	8	1/4	28	27	14,5	11,2	17	10



ART. SSB-G

T centrale girevole filetto cilindrico
Swivel male stud T parallel

CODICE	ØD	G	L1	L2	L3	ØD1		
SSB04-M5	4	M5	4	17,5	36,6	10	10	10
SSB04-G01	4	1/8	5,5	20	36,6	10	13	10
SSB06-M5	6	M5	4	17,5	40,6	12	10	5
SSB06-G01	6	1/8	5,5	22	40,6	12	13	5
SSB06-G02	6	1/4	6,5	23	40,6	12	16	5
SSB08-G01	8	1/8	5,5	22,5	44,6	14	13	5
SSB08-G02	8	1/4	6,5	23,5	44,6	14	16	5
SSB10-G02	10	1/4	6,5	31	52,8	17	17	5
SSB10-G03	10	3/8	7,5	28,5	52,8	17	20	5
SSB12-G03	12	3/8	7,5	30	58,8	20	20	5
SSB12-G04	12	1/2	9	30,5	58,8	20	24	5

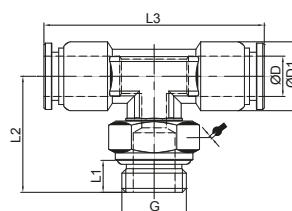

ART. SSB

 T centrale girevole filetto conico
Swivel male stud T tapered

CODICE	ØD	R	L1	L2	L3	ØD1		
SSB04-01	4	1/8	7,5	20	36,6	10	12	10
SSB06-01	6	1/8	7,5	23	40,6	12	12	5
SSB06-02	6	1/4	9,5	23	40,6	12	14	5
SSB08-01	8	1/8	7,5	23,5	44,6	14	12	5
SSB08-02	8	1/4	9,5	23,5	44,6	14	14	5
SSB10-02	10	1/4	9,5	33	52,8	17	17	5
SSB10-03	10	3/8	10,5	30	52,8	17	17	5
SSB12-03	12	3/8	10,5	31,5	58,8	20	17	5
SSB12-04	12	1/2	13,5	33,5	58,8	20	21	5

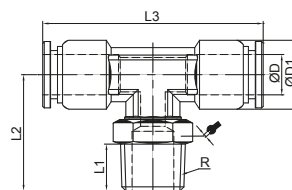
ART. SSGJ

 Riduzione con codolo
Plug-in reducer

CODICE	ØD	D1	D2	L1	
SSGJ06-04	4	10,5	6	41	10
SSGJ08-06	6	12,5	8	44	10
SSGJ08-04	4	10,5	8	43	10
SSGJ10-08	8	14,5	10	47	10
SSGJ10-06	6	12,5	10	47	10
SSGJ12-10	10	17,5	12	53	10
SSGJ12-08	8	14,5	12	52	10
SSGJ14-10	10	17,5	14	56	10

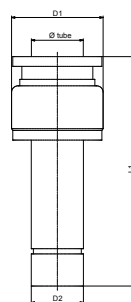
ART. SSM

 Passaparete innestabile
Bulkhead connector

CODICE	ØD	ØD1	L	L1 max	M		
SSM04	4	10	27	8	M12x1	14	10
SSM06	6	12	29,5	8	M14x1	17	10
SSM08	8	14	32,5	8,5	M16x1	19	5
SSM10	10	17	36,8	9,5	M20x1	24	5
SSM12	12	20	39,8	11,5	M22x1	26	5
SSM14	14	24	42	17	M24x1	27	5

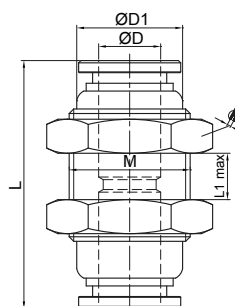

ART. SSU

Diritto innestabile uguale
Equal straight connector

CODICE	ØD	ØD1	L	
SSU04	4	11	27	10
SSU06	6	13	29,5	10
SSU08	8	15	32,5	10
SSU10	10	18	36,8	5
SSU12	12	21	39,8	5
SSU14	14	22	42	5

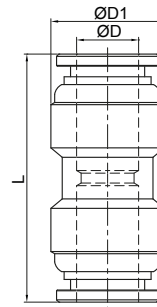

ART. SSG

Diritto innestabile riduzione
Reducer straight connector

CODICE	ØD1	ØD2	D1	D2	L1	
SSG04-06	4	6	10,5	12,5	30,6	10
SSG06-08	6	8	12,5	14,5	32,8	10
SSG08-10	8	10	14,5	17,5	35	10
SSG10-12	10	12	17,5	20,5	38,2	10

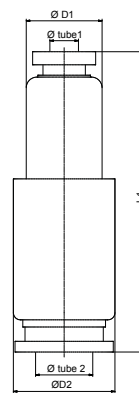

ART. SSV

Gomito innestabile
L connector

CODICE	ØD	ØD1	L	
SSV04	4	10	18,3	10
SSV06	6	12	20,3	10
SSV08	8	14	22,3	10
SSV10	10	17	26,4	5
SSV12	12	20	29,4	5
SSV14	14	22	37	5

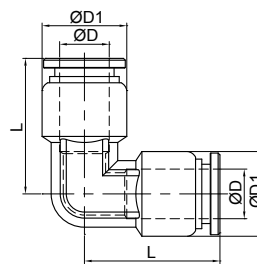

ART. SSE

T innestabile
T connector

CODICE	ØD	ØD1	L	L1	
SSE04	4	10	18,3	36,6	10
SSE06	6	12	20,3	40,6	5
SSE08	8	14	22,3	44,6	5
SSE10	10	17	26,4	52,8	5
SSE12	12	20	29,4	58,8	5
SSE14	14	14	37	74	5

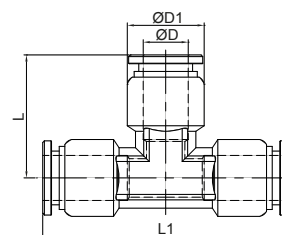

ART. SSY

 Y innestabile
Y connector

CODICE	ØD	L1	L2	D2		
SSY04	4	36	14	11		10
SSY06	6	37,5	16	13		10
SSY08	8	41,3	18	15		10
SSY10	10	44,3	21	18		10
SSY12	12	51	24	21		10

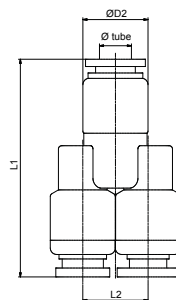
ART. SSP

 Tappo
Plug

CODICE	D1	D2	L1			
SSP04	6	4	28			10
SSP06	8	6	33			10
SSP08	10	8	37			10
SSP10	12	10	42			10
SSP12	14	12	44			10
SSP14	16	14	46			10

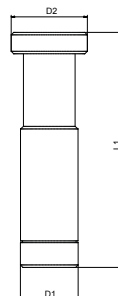
ART. SSN-G

 Regolatore di flusso per cilindro girevole
Swivel flow regulator for cylinder

CODICE	ØD	G	L1	L2	L3	D2		
SSN04-G01	4	1/8	34,5	28	7,5	10,5	12	10
SSN04-G02	4	1/4	43	28	9,5	10,5	14	10
SSN06-G01	6	1/8	34,5	28	7,5	12,5	12	10
SSN06-G02	6	1/4	43	28	9,5	12,5	14	10
SSN08-G01	8	1/8	34,5	30	7,5	14,5	12	10
SSN08-G02	8	1/4	43	30	9,5	14,5	14	10
SSN08-G03	8	3/8	47,3	33	10,5	14,5	19	10
SSN08-G04	8	1/2	51	33	12,5	14,5	22	10
SSN10-G02	10	1/4	43	32,5	9,5	17,5	14	10
SSN10-G03	10	3/8	47,3	35	10,5	17,5	19	10
SSN10-G04	10	1/2	51	35	12,5	17,5	22	10
SSN12-G02	12	1/4	43	36	9,5	20,5	14	10
SSN12-G03	12	3/8	47,3	38	10,5	20,5	19	10
SSN12-G04	12	1/2	51	38	12,5	20,5	22	10

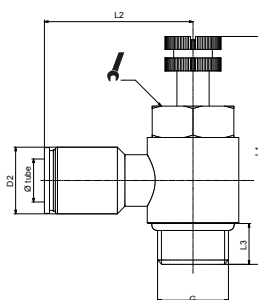

BREVE DESCRIZIONE

I raccordi automatici della nostra serie inox SS sono “oil free” e realizzati in conformità agli standard di qualità secondo le normative ISO di riferimento e rispondono alle seguenti specifiche tecniche e applicative.

SHORT DESCRIPTION

The stainless steel push-in fittings “SS” series are “oil free” and manufactured according to the ISO norms of reference, and suitable for the following technical and applicative specifications.

SCHEMA TECNICA TECHNICAL SHEET

FLUIDI UTILIZZABILI <i>EMPLOYABLE FLUIDS</i>		Aria compressa, acqua, vapore (per altri fluidi sentire il nostro Ufficio Tecnico) <i>Compressed air, water, steam (for different fluid pls contact our Technical Dept.)</i>
APPLICAZIONI <i>APPLICATIONS</i>		Pneumatica applicata a settori industriali quali: medicale, chimico e alimentare. In generale ove siano richiesti requisiti di anti-corrosione, resistenza agli acidi e temperature elevate. <i>Pneumatic equipments which are applied widely in the range of Industry such as food service industry, chemical industry and medical industry. In general where required to ensure anti-corrosion and acid resistant, or usage at high temperature.</i>
TUBI CONSIGLIATI <i>SUGGESTED TUBES</i>		TPU (Poliuretano), PA11/PA12 (Poliammide), TPE (Polietilene), TCO (Copoliestere) <i>TPU (Polyurethane), PA11/PA12 (Polyamide), TPE (Polyethylene), TCO (Copolyester)</i>
TOLLERANZE TUBI <i>TUBES TOLERANCES</i>		Diam. da 4 a 10 mm +/- 0,05 Diam. da 12 mm +/- 0,1 <i>Diam. between 4 and 10 mm +/- 0,05 Diam. from 12 mm +/- 0,1</i>
VALORI LIMITE CONSIGLIATI <i>RECOMMENDED LIMIT VALUES</i>	TEMPERATURE <i>TEMPERATURES</i>	Le temperature di esercizio sono comprese in un campo fra -20°C e +120°C. <i>The working temperatures range is between -20°C and +120°C</i>
	PRESSIONI <i>PRESSURES</i>	Le pressioni di esercizio sono comprese in un campo fra 0 e 1,2MPa (0-12bar). <i>The working pressure range is between 0 and 1,2MPa (0-12Bar).</i>
	NOTA <i>NOTE</i>	Per dati più puntuali consultare il catalogo tecnico del proprio fornitore di tubi. <i>For more complete informations pls read the technical catalogue of your tube supplier.</i>
FILETTATURE <i>THREAD TYPE</i>		BSP cilindrica UNI-ISO 228; BSP conica UNI-ISO 7; Metrica ISO/R 262. <i>BSP parallell UNI-ISO 228; BSP tapered UNI-ISO 7; Metric ISO/R 262</i>
MATERIALI <i>MATERIALS</i>	corpo, spintore, distanziale, sottomolla <i>body, sleeve, collar and back ring</i>	Acciaio inox SUS316 <i>Stainless Steel SUS316</i>
	pinza <i>spring</i>	Acciaio Inox SUS301 <i>Stainless Steel SUS301</i>
	guarnizioni tenuta <i>seals</i>	Viton/FKM/FPM <i>FPM/FKM/Viton</i>
NOTA IMPORTANTE <i>IMPORTANT NOTE</i>		La materia prima è amagnetica, comunque dopo la lavorazione a freddo, una piccola quantità di austenite potrebbe essere trasformata in martensite, che potrebbe essere molto debolmente magnetica. <i>The raw material is non-magnetic, however after cold working, a small amount of austenite could be transformed into martensite, which could be very weakly magnetic.</i>

Esito dei test di compatibilità alle specifiche FDA effettuati da **TUV NORD** per conto del produttore

	TEST REPORT N.	DATA	DURATA (GIORNI)	COMPONENTE	MATERIALE	OBIETTIVO DEL TEST
A	TRHZ1208110	06/08/2012	6	GUARNIZIONE DI TENUTA	VITON FPM FLUORO-RUBBER (FKM)	CONFORMITA' ALLE SPECIFICHE FDA PER DETERMINARE IL GRADO DI ESTRAZIONE DI CLOROFORMIO SOLUBILE (ppm) NELLE GUARNIZIONI DI TENUTA PER CHIUSURA DI CONTENITORI ALIMENTARI
B	TRHZ1208111	06/08/2012	6	RACCORDO AD L MOD. SSV	ACCIAIO INOSSIDABILE SUS316L	DETERMINAZIONE DEL CONTENUTO TOTALE DI CROMO
C	TRHZ1208112	06/08/2012	6	RACCORDO DIRITTO MOD. SSC-G	ACCIAIO INOSSIDABILE SUS316L	DETERMINAZIONE DEL CONTENUTO TOTALE DI CROMO

	METODO DEL TEST (ref. FDA 21 CFR 177.1210)	RISULTATO	CONCLUSIONI
A	IMMERSIONE PER 2 ORE IN ACQUA DISTILLATA A 212°F	VALORE RILEVATO 13,0 VALORE LIMITE 50,0	IL RISULTATO DEL TEST SUI CAMPIONI PRESENTATI SONO CONFORMI ALLE SPECIFICHE FDA PER DETERMINARE LA QUANTITA' DI ESTRATTIVI DI CLOROFORMIO SOLUBILE AMMESSI
	IMMERSIONE PER 2 ORE IN ALCOHOL 8% A 212°F	VALORE RILEVATO 7,0 VALORE LIMITE 50,0	
	IMMERSIONE PER 2 ORE IN EPTANO NORMALE (N-EPTANO) A 150 °F	VALORE RILEVATO 11,5 VALORE LIMITE 50,0	
B	ANALISI VOLUMETRICA (TITOLAZIONE)	VALORE RILEVATO 16,38% VALORE RICHIESTO $\geq 10,5\%$	IL RISULTATO DEL TEST SUL CAMPIONE PRESENTATO DETERMINA CHE ESSO E' IDONEO AL CONTATTO CON GLI ALIMENTI
C	ANALISI VOLUMETRICA (TITOLAZIONE)	VALORE RILEVATO 17,18% VALORE RICHIESTO $\geq 10,5\%$	IL RISULTATO DEL TEST SUL CAMPIONE PRESENTATO DETERMINA CHE ESSO E' IDONEO AL CONTATTO CON GLI ALIMENTI



 Test results to FDA specifications compatibility, made by **TUV NORD** on behalf of the manufacturer

	TEST REPORT N.	DATE	PERIOD (DAYS)	ITEM	MAIN MATERIAL	TEST PURPOSE
A	TRHZ1208110	06/08/2012	6	SEAL RING	FPM FLUORORUBBER VITON (FKM)	THE COMPLIANCE WITH THE FOOD AND DRUG ADMINISTRATION REGULATIONS FOR DETERMINING THE AMOUNT OF CHLOROFORM-SOLUBLE EXTRACTIVES (ppm) FROM CLOSURES WITH SEALING GASKETS FOR FOOD CONTAINERS
B	TRHZ1208111	06/08/2012	6	ELBOW FITTING MOD. SSV	STAINLESS STEEL SUS316L	TO DETERMINE TOTAL CHROMIUM CONTENT IN THE SUBMITTED SAMPLE
C	TRHZ1208112	06/08/2012	6	STRAIGHT FITTING MOD. SSC-G	STAINLESS STEEL SUS316L	TO DETERMINE TOTAL CHROMIUM CONTENT IN THE SUBMITTED SAMPLE

	TEST METHOD (ref. FDA 21 CFR 177.1210)	TEST RESULT	CONCLUSION
A	IMMERSION FOR 2 HOURS IN DISTILLED WATER AT 212 ° F	DETECTED VALUE 13,0 MAX PERMISSIBLE 50,0	WHEN TESTED AS SPECIFIED, THE TEST RESULTS OF THE SUBMITTED SAMPLE COMPLY WITH THE FDA SPECIFICATIONS FOR DETERMINING THE AMOUNT OF CHLOROFORM-SOLUBLE EXTRACTIVES FOR CLOSURES (CLOS)
	IMMERSION FOR 2 HOURS IN ALCOHOL 8% AT 212°F	DETECTED VALUE 7,0 MAX PERMISSIBLE 50,0	
	IMMERSION FOR 2 HOURS IN n-HEPTANE AT 150°F	DETECTED VALUE 11,5 MAX PERMISSIBLE 50,0	
B	TITRATION METHOD	DETECTED VALUE 16,38% REQUIREMENT $\geq 10,5\%$	WHEN TESTED AS SPECIFIED, THE TEST RESULTS OF THE SUBMITTED SAMPLE IS SUITABLE FOR CONTACT WITH FOOD
C	TITRATION METHOD	DETECTED VALUE 17,18% REQUIREMENT $\geq 10,5\%$	WHEN TESTED AS SPECIFIED, THE TEST RESULTS OF THE SUBMITTED SAMPLE IS SUITABLE FOR CONTACT WITH FOOD

ART. RX102

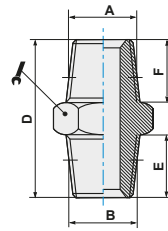

Niplo conico
Taper nipple

CODICE	A	B	D	E	F		
RX1021818	G1/8	G1/8	21	7,5	7,5	14	10
RX1021814	G1/8	G1/4	23	7,5	9,5	14	10
RX1021414	G1/4	G1/4	25	9,5	9,5	17	10
RX1021438	G1/4	G3/8	25	9,5	10,5	17	10
RX1021412	G1/4	G1/2	26,5	13	9,5	24	5
RX1023838	G3/8	G3/8	26,5	10,5	10,5	21	10
RX1023812	G3/8	G1/2	29	10,5	13	24	5
RX1021212	G1/2	G1/2	31	13	13	21	5



ART. RX103

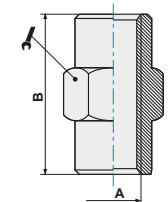

Manicotto filettato
Sleeve

CODICE	A	B					
RX10318	G1/8	17				14	10
RX10314	G1/4	23				17	10
RX10338	G3/8	25				21	5
RX10312	G1/2	28				24	5



ART. RX104

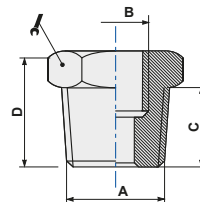

Riduzione M/F conica
Taper reducer

CODICE	A	B	C	D			
RX1041418	G1/4	G1/8	10	16		17	10
RX1043818	G3/8	G1/8	11,5	18		17	10
RX1041218	G1/2	G1/8	12	18		21	5
RX1043814	G3/8	G1/4	11,5	18		21	10
RX1041214	G1/2	G1/4	12	18		24	5
RX1041238	G1/2	G3/8	12	18		24	5



ART. RX104Z

Riduzione M/F cilindrica con O.R.
Parallel reducer with O.R.

CODICE	A	B	C	D			
RX104Z18M5	G1/8	M5	5,5	12,5		14	10
RX104Z1418	G1/4	G1/8	6,5	13,5		17	10
RX104Z3814	G3/8	G1/4	7,5	14,5		21	10

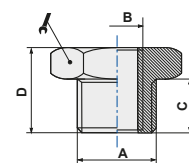

ART. RX107Z

 Tappo maschio cilindrico con O.R.
Parallel male plug with O.R.

CODICE	A	B	C				
RX107Z18	G1/8	12,5	5,5			14	10
RX107Z14	G1/4	13,5	6,5			17	10
RX107Z38	G3/8	14,5	7,5			21	5
RX107Z12	G1/2	16	9			24	5

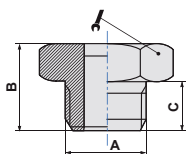
ART. RX109

 L.F.F.
Female L

CODICE	A	B	C				
RX10918	G1/8	9,5	22,5			11	10
RX10914	G1/4	11,5	25			13	5
RX10938	G3/8	12,5	28			15,6	5
RX10912	G1/2	15	31,5			20,6	10

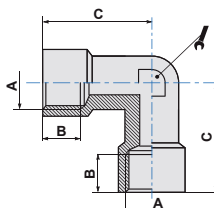
ART. RX110

 L.M.F.
Male-Female L

CODICE	A	A1	B	B1	C	D		
RX11018	G1/8	G1/8	9,5	7,5	22,5	18,5	11	5
RX11014	G1/4	G1/4	11,5	10	25	22,5	13	5
RX11038	G3/8	G3/8	12,5	11,5	28	25	15,6	5
RX11012	G1/2	G1/2	15	12	31,5	29,5	20,6	5

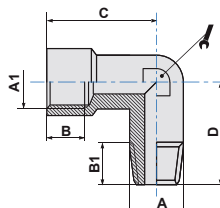
ART. RX111

 T.F.F.F.
Female T

CODICE	A	B	C	D			
RX11118	G1/8	7,5	7,5	18,5		11	5
RX11114	G1/4	10	25	50		13	5
RX11138	G3/8	11,5	27	58,5		15	5
RX11112	G1/2	12	31	67		20,6	5

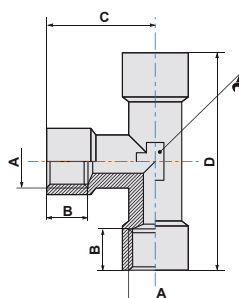
ART. RX112

 T.F.M.F.
Centre male T

CODICE	A	B	B1	C	D		
RX11218	G1/8	7,5	9,5	18,5	45	11	5
RX11214	G1/4	10	11,5	22,5	50	13	5
RX11238	G3/8	11,5	12,5	25	58,5	15,6	5
RX11212	G1/2	12	15	29,5	67	20,6	5

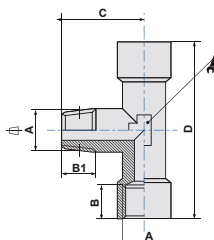

ART. RX115

Elle M.M.
Male L

CODICE	A	B	C	A1	B1		
RX11518	G1/8	7,5	17	8,5	7,5	9	10
RX11514	G1/4	10	21	10,5	10	11	5
RX11538	G3/8	10,5	23,5	12,5	10,5	13	5
RX11512	G1/2	13	26,7	15	13	15,6	5

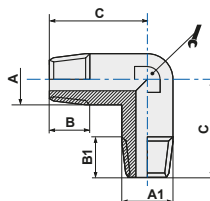

ART. RX301

Raccordo diritto maschio conico
Taper straight male adaptor

CODICE	ØD	F	I	H			
RX30106M5	6/4	M5	4	23,7	12	12	10
RX3010618	6/4	G1/8	7,5	25	12	12	10
RX3010614	6/4	G1/4	9,5	27	12	14	10
RX3010818	8/6	G1/8	7,5	26,2	14	14	10
RX3010814	8/6	G1/4	9,5	30,5	17	17	5
RX3011014	10/8	G1/4	10	31,5	17	17	

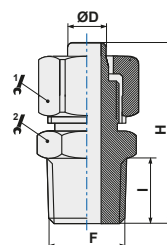

ART. RX302

Raccordo diritto femmina
Straight female adaptor

CODICE	ØD	F	I	H	H1			
RX3020618	6/4	G1/8	9,5	23	10,5	12	14	10
RX3020614	6/4	G1/4	11,5	25	12,5	12	17	10
RX3020818	8/6	G1/8	9,5	24	11	14	14	10
RX3020814	8/6	G1/4	11,5	26	12,5	14	17	10

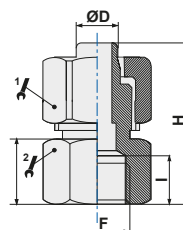

ART. RX303

Raccordo diritto intermedio
Straight connector

CODICE	ØD	L			
RX3030600	6/4	30	12	12	10
RX3030800	8/6	32	14	14	10
RX3031000	10/8	37	17	17	5
RX3031200	12/10	41	19	19	5

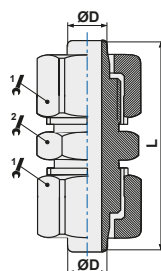

ART. RX305

 Raccordo ad L maschio conico
L taper male adaptor

CODICE	ØD	F	I	H	L			
RX3050418	4/2,5	G1/8	8,5	17	16	8	9	10
RX3050618	6/4	G1/8	11	21	21	12	9	10
RX3050614	6/4	G1/4	11	21	21	12	11	10
RX3050818	8/6	G1/8	8,5	18	23	14	11	10
RX3050814	8/6	G1/4	11	22,3	23	14	11	10
RX3051014	10/8	G1/4	11	23,5	25	17	13	5
RX3051038	10/8	G3/8	14	25	25	17	13	5

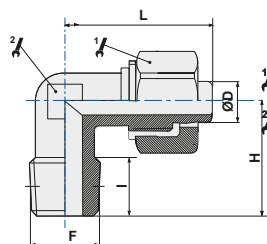
ART. RX306

 Raccordo ad L intermedio
L connector

CODICE	ØD	L			
RX3060600	6/4	21	12	9	10
RX3060800	8/6	22,5	14	11	10
RX3061000	10/8	25	17	13	5
RX3061200	12/10	27,5	19	15,5	5

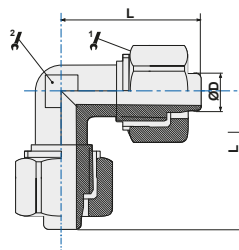
ART. RX307

 Raccordo T centrale
Central T adaptor

CODICE	ØD	F	I	H	L			
RX3070618	6/4	G1/8	11,5	22	41,5	12	9	10
RX3070614	6/4	G1/4	9	22	41,5	12	9	5
RX3070818	8/6	G1/8	8,5	18	44,5	14	11	5
RX3070814	8/6	G1/4	12	24	44	14	11	5
RX3071014	10/8	G1/4	11,5	24	50,5	17	13	5

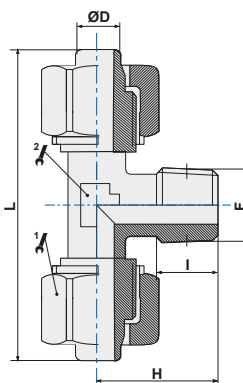
ART. RX309

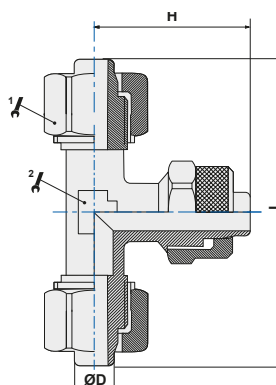

 Raccordo T intermedio
connector

CODICE	ØD	H	L			
RX3090600	6/4	20,5	41	12	9	5
RX3090800	8/6	23,5	44,5	14	11	5
RX3091000	10/8	26,5	50,7	17	13	5
RX3091200	12/10	27,5	55,4	19	13	5



ART. RX310

Dado di serraglio
Locking nut

CODICE	ØD	F	H		
RX3100600	6/4	M10x1	10	12	10
RX3100800	8/6	M12x1	10	14	10
RX3101000	10/8	M14x1	12	17	10

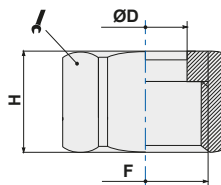

BREVE DESCRIZIONE

I raccordi accessori della nostra serie inox RX sono "oil free" e realizzati in conformità agli standard di qualità secondo le normative ISO di riferimento, e rispondono alle seguenti specifiche tecniche e applicative.

SHORT DESCRIPTION

The stainless steel accessory fittings "RX" series are "oil free" and manufactured according to the ISO norms of reference, and suitable for the following technical and applicative specifications.

SCHEDA TECNICA TECHNICAL SHEET

FLUIDI UTILIZZABILI <i>EMPLOYABLE FLUIDS</i>		Aria compressa, alcuni liquidi (per altri fluidi sentire il nostro Ufficio Tecnico) <i>Compressed air, some liquids (for different fluid pls contact our Technical Dept.)</i>
APPLICAZIONI <i>APPLICATIONS</i>		Pneumatica applicata a settori industriali quali: medicale, chimico e alimentare. In generale ove siano richiesti requisiti di anti-corrosione, resistenza agli acidi e temperature elevate. <i>Pneumatic equipments which are applied widely in the range of Industry such as food service industry, chemical industry and medical industry. In general where required to ensure anti-corrosion and acid resistant, or usage at high temperature.</i>
TUBI CONSIGLIATI PER LA SERIE A CALZAMENTO <i>SUGGESTED TUBES FOR THE QUICK SERIES</i>		4x2,5; 6x4; 8x6; 10x8; 12x10; 14x11; 16x13;
VALORI LIMITE CONSIGLIATI <i>RECOMMENDED LIMIT VALUES</i>	TEMPERATURE <i>TEMPERATURES</i>	Le temperature di esercizio sono comprese in un campo fra -20°C e +120°C. <i>The working temperatures range is between -20°C and +120°C</i>
	PRESSIONE DI ESERCIZIO <i>WORKING PRESSURES</i>	La pressione di esercizio dipende dal tipo di tubo impegnato, valore massimo 25bar. <i>The working pressure depends on the type of employed pipe, maximum value 25bar</i>
FILETTATURE <i>THREAD TYPE</i>		BSP cilindrica UNI-ISO 228; BSP conica UNI-ISO 7; Metrica ISO/R 262. <i>BSP parallel UNI-ISO 228; BSP tapered UNI-ISO 7; Metric ISO/R 262</i>
MATERIALI <i>MATERIALS</i>	corpo e dado serie a calzamento <i>body and nut quick series</i>	Acciaio inox SUS316 <i>Acciaio inox SUS316</i>
	corpo serie di linea <i>body transition series</i>	Acciaio inox SUS316 <i>Acciaio inox SUS316</i>
	guarnizioni tenuta <i>seals</i>	Viton/FKM/FPM <i>FPM/FKM/Viton</i>
NOTA IMPORTANTE <i>IMPORTANT NOTE</i>		La materia prima è amagnetica, comunque dopo la lavorazione a freddo, una piccola quantità di austenite potrebbe essere trasformata in martensite, che potrebbe essere molto debolmente magnetica. <i>The raw material is non-magnetic, however after cold working, a small amount of austenite could be transformed into martensite, which could be very weakly magnetic.</i>



MINI

- 1 **CORPO DEL RACCORDO**
FITTING BODY
- 2 **ANELLO ELASTICO**
ELASTIC RING
- 3 **ASTINA GIREVOLE**
SWIVEL STEM
- 4 **O-RING DI TENUTA**
O-RING SEAL
- 5 **ANELLO SPINGITORE E AGGRAFFAGGIO**
THRUST AND CRIMPING SLEEVE

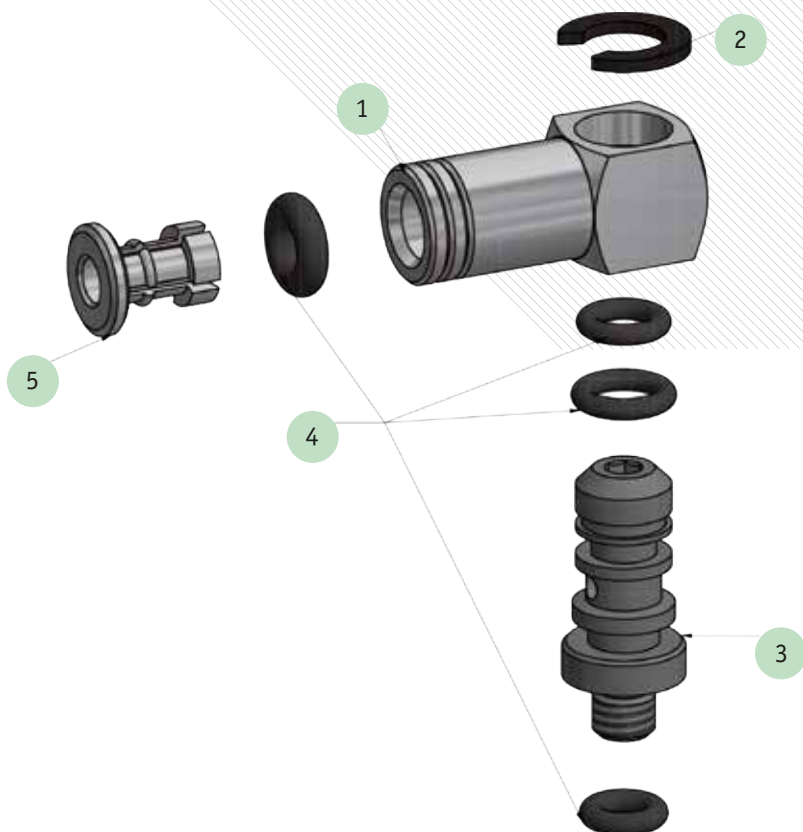

ART. RDR

Diritto filetto cilindrico maschio con O-Ring
Straight male adaptor (parallel)

CODICE	D	G	C	H	L		⌀	
RDR3.20	2,0	M3	5,4	3	13,5		1,5	100
RDR3.30	3,0	M3	5,8	3	14,5		1,5	100
RDR3.31	3,17	M3	5,8	3	14,0		1,5	100
RDR3.40	4,0	M3	7,0	3	15,5		1,5	100
RDR3.40-MH05	4,0	M3	6,9	5	17,5		1,5	100
RDR5.20	2,0	M5	5,4	3,5	13,0		1,5	100
RDR5.30	3,0	M5	5,8	3,5	14,5		2,0	100
RDR5.31	3,17	M5	5,8	3,5	14,5		2,0	100
RDR5.40	4,0	M5	5,8	3,5	16,5		2,0	100
RDR6.40-FH12	4,0	M6	7	12	24,5		2,0	100
RDR6.40-MH12	4,0	M6	7	12	24,5		2,0	100

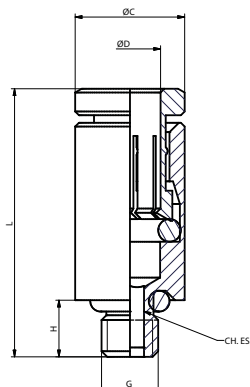

ART. RGR

Asta con filetto cilindrico in anello semplice
Complete single banjo with stem

CODICE	D	G	C	H	L	L1	⌀	
RGR3.20	2	M3	1,4	3,0	13,5	13,5	1,5	100
RGR3.30	3	M3	1,4	3,0	13,5	13,5	1,5	100
RGR3.31	3,17	M3	1,4	3,0	13,5	13,5	1,5	100
RGR3.40	4,2	M3	1,4	3,0	13,5	13,5	1,5	100
RGR3.40-MH05	4,2	M3	1,4	5,0	13,5	13,5	1,5	100
RGR5.20	2	M5	2,0	3,5	14	14	2,0	100
RGR5.30	3	M5	2,0	3,5	14	14	2,0	100
RGR5.31	3,2	M5	2,0	3,5	13,5	13,5	2,0	100
RGR5.40	4,2	M5	2,0	3,5	13,5	13,5	2,0	100
RGR6.40-FH12	4,2	M6	2,0	12	13,5	13,5	2,0	100
RGR6.40-MH12	4,0	M6	2,0	12	13,5	13,5	2,0	100

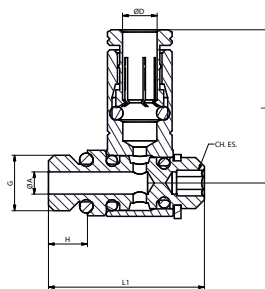

ART. RDSR

Diritto maschio cilindrico con scarico rapido
Quick exhaust straight male parallel adapter

CODICE	L	ØC	ØD	G	H		⌀	
RDSR520	18,5	6,8	2,0	M5	3,5		7	100
RDSR530	18,5	6,8	3,0	M5	3,5		7	100
RDSR531	18,3	6,8	3,0	M5	3,5		7	100
RDSR540	19,5	7,8	4,2	M5	3,5		8	100

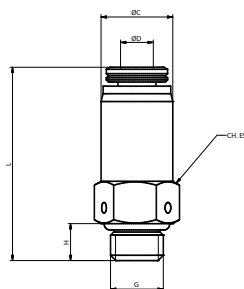

ART. RGSR

Gomito girevole cilindrico con scarico rapido
Quick exhaust swivel L parallel adapter

CODICE	ØB	ØD	H	H2	E	G	⊙	📄
RGSR520	5,8	2,1	3,5	19	14	M5	7	100
RGSR530	5,8	3,0	3,5	19	14	M5	7	100
RGSR531	5,8	3,2	3,5	19	14	M5	7	100
RGSR540	5,8	4,2	3,5	19	14	M5	7	100

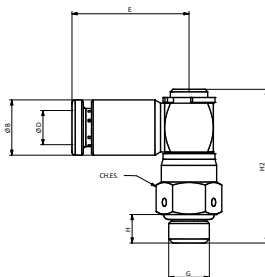

ART. RRR

Riduzione con codolo
Plug-in reducer

CODICE	ØD1	ØD2	ØB	L	📄
RRR3020 *	2,0	3,2	5,8	23,2	100
RRR4020	4,0	2,0	5,8	25,5	100
RRR4030	4,0	3,0	5,8	25,5	100

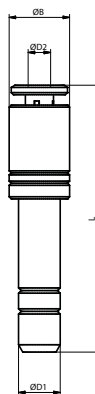

ART. RTR

T combinato intermedio
T combined connector

CODICE	ØC	L1	L2	G	H	ØB	ØA	L3	⊙	📄
RTR020	2,10	13,7	12			5,8	5,8	3	6	100

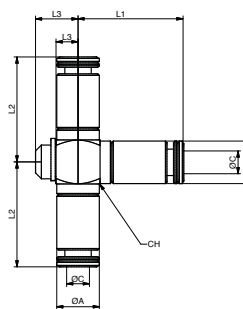

ART. RTR

T combinato filettato
T combined thread

CODICE	ØC	L1	L2	G	H	ØB	ØA	L3	⊙	📄
RTR330	3,0	7,7	14	M3	3	5,8	5,8	5,8	6	100

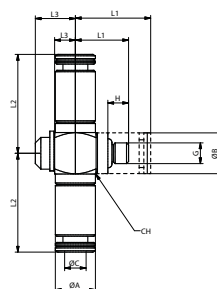

BREVE DESCRIZIONE

La serie dei raccordi MINI supercompatta, estremamente leggera ma robusta, si può innestare e disinnestare con una mano, ed è utilizzabile con tubi PA, TPU, Ny e PE. L'O-Ring è provvisto della propria sede per assicurare la tenuta su superfici pulite

SHORT DESCRIPTION

The MINI supercompact fittings series, extremely lightweight yet sturdy, can be inserted and extracted with one hand and it is suitable for tube PA, TPU, Ny and PE. The O-Ring is provided with his own seat to ensure seal with polished surface.

SCHEMA TECNICA TECHNICAL SHEET

FLUIDI UTILIZZABILI <i>EMPLOYABLE FLUIDS</i>		Aria compressa (per altri fluidi contattare il nostro Ufficio Tecnico) <i>Compressed air (for different fluid pls contact our Technical Dept.)</i>
APPLICAZIONI <i>APPLICATIONS</i>		Impianti pneumatici, idoneo anche per applicazioni con il vuoto. <i>BSP parallell UNI-ISO 228; BSP tapered UNI-ISO 7; Metric ISO/R 262</i>
TUBI CONSIGLIATI <i>SUGGESTED TUBES</i>		TPU (Poliuretano), PA11/PA12 (Poliammide), TPE (Polietilene), TCO (Copoliestere) <i>TPU (Polyurethane), PA11/PA12 (Polyamide), TPE (Polyethilene), TCO (Copolyester).</i>
FILETTATURE <i>THREAD TYPE</i>		Cilindrica con O-Ring. <i>Cylindrical with O-ring.</i>
VALORI LIMTE CONSIGLIATI <i>RECOMMENDED LIMIT VALUE</i>	COPPIA DI SERRAGGIO MASSIMA <i>MAXIMUM TORQUE</i>	Filettatura M3 = 0,4 Nm; Filettatura M6 e M6x0,75 = 1,3 Nm <i>Thread M3 = 0,4 Nm; Thread M6 and M6x0,75 = 1,3 Nm</i>
	TEMPERATURE <i>TEMPERATURES</i>	Le temperature di esercizio sono comprese fra -20°C e +70°C <i>The working temperatures range is between -20°C and +70°C</i>
	PRESSIONI <i>PRESSURES</i>	La pressione di esercizio massima è 10 bar <i>The maximum working pressure is 10 Bar.</i>
MATERIALI <i>MATERIALS</i>	CORPO <i>BODY</i>	Ottone nichelato <i>Nichel-plated</i>
	PINZA <i>GRIP</i>	Ottone <i>Brass</i>
	GUARNIZIONI TENUTA <i>SEALS</i>	NBR esenti da silicone <i>Silicon free NBR</i>
NOTE <i>NOTES</i>		Prodotto gestito direttamente da Pneumax S.p.a. <i>Product managed directly from Pneumax S.p.A</i>



1

ISTRUZIONI DI MONTAGGIO - FITTING INSTRUCTIONS
Prima dell'inserimento - Before the insertion

- Il tipo di tubo utilizzato deve essere dichiarato dal costruttore idoneo all'utilizzo con raccordi automatici
The type of employed pipe must be declared as suitable by the manufacturer to be used with push-in fittings
- Il taglio del tubo deve essere effettuato a 90° mediante apposita pinza taglia tubo (Vedi nostro catalogo bluline)
The cutting of the pipe must be at a right angle using a dedicated tube cutter (See our bluline catalogue)
- Non effettuare il taglio del tubo con forbici, tenaglie o altri utensili che possano conferire all'estremità del tubo estremità non lineari
Do not cut the hose with scissors, pincers or other tools may cause non-linear surface to the end of the tube



2

INSERIMENTO CORRETTO DEL TUBO SUL RACCORDO
CORRECT INSERTION OF THE HOSE IN THE FITTING

3

FOTO 1 - PICTURE 1

 Tubo prima dell'inserimento - *Hose before insertion*

FOTO 2 - PICTURE 2

 Tubo inserito - *Inserted hose*

FOTO 3 - PICTURE 3

 Tubo tagliato a 90° con pinza in plastica - *Tubo tagliato a 90° con pinza*

4

FOTO 4 - PICTURE 4

 Tubo tagliato in modo corretto con pinza in metallo - *Correct hose cut with metal tube cutter*
Durante l'inserimento - During the insertion

- Effettuare una leggera rotazione del tubo in modo da agevolarne l'ingresso, assicurarsi di arrivare con il tubo fino a quota di battuta interna.
Turn the hose slightly so to make it easier to get in, make sure the pipe reach the inside stop.

Sgancio del tubo - Hose extraction

- Per effettuare lo sgancio del tubo, o disinnesto, premere il tappo spintore fino a battuta, mantenendo la pressione su quest'ultimo estrarre il tubo dal corpo (l'operazione può essere facilitata con l'utilizzo di apposita forchettina).
To extract the hose, or realising it, press the sleeve until it stops and keeping it pressed remove the tube from the fitting (the operation can be done easier using an appropriate fork).
- Assicurarsi che il tubo inserito non sia soggetto a trazione e che il tappo spintore non venga a contatto con nessun tipo di oggetto in modo da non generare sganci o sfilamenti involontari.
Make sure that the inserted hose is not under traction and that the sleeve does not run the risk of accidental contacts which may cause unintentional extraction or releasing.



5

FOTO 5 - PICTURE 5

 Raccordo con tubo inserito e in trazione - *Fitting with inserted hose, in tension.*

6

FOTO 6 - PICTURE 6

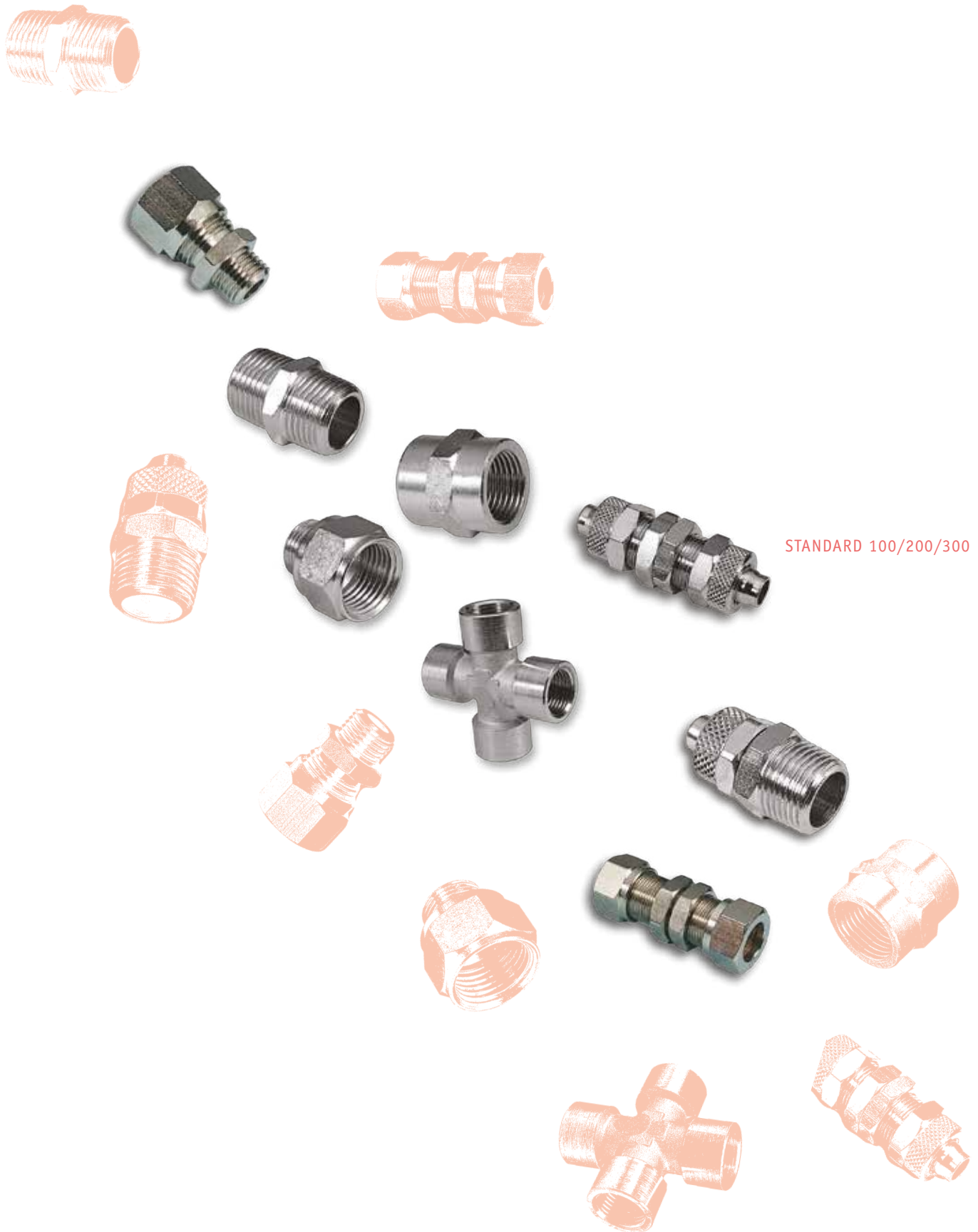

 Raccordo con tubo inserito avente raggio di curvatura stretto - *Fitting with hose inserted, having a tight bending radius.*



STANDARD 100/200/300



ART. 101

 Nipplo cilindrico
Parallel nipple

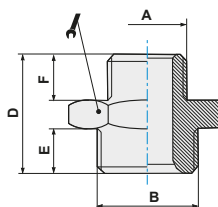
CODICE	A	B	D	E	F		
101M5M5	M5	M5	11,5	4	4	8	100
101M518	M5	G1/8	14,5	6	4	14	100
1011818	G1/8	G1/8	16,5	6	6	14	100
1011814	G1/8	G1/4	19,0	8	6	17	100
1011838	G1/8	G3/8	20,0	9	6	19	100
1011414	G1/4	G1/4	21,0	8	8	17	100
1011438	G1/4	G3/8	22,0	9	8	19	100
1011412	G1/4	G1/2	23,5	10	8	24	100
1013838	G3/8	G3/8	23,0	9	9	19	50
1013812	G3/8	G1/2	24,5	10	9	24	50
1011212	G1/2	G1/2	25,5	10	10	24	50
1011234	G1/2	G3/4	27,5	11	10	30	25
1013434	G3/4	G3/4	28,5	11	11	30	25

ART. 102

 Nipplo conico
Taper nipple

CODICE	A	B	D	E	F		
1021818	G1/8	G1/8	20,0	8,0	8,0	12	100
1021814	G1/8	G1/4	24,0	11,0	8,0	14	100
1021838	G1/8	G3/8	24,5	11,5	8,0	17	100
1021812	G1/8	G1/2	27,5	14,0	8,0	22	50
1021414	G1/4	G1/4	27,0	11,0	11,0	14	100
1021438	G1/4	G3/8	27,5	11,5	11,0	17	100
1021412	G1/4	G1/2	30,5	14,0	11,0	22	50
1023838	G3/8	G3/8	28,0	11,5	11,5	17	100
1023812	G3/8	G1/2	31,0	14,0	11,5	22	50
1021212	G1/2	G1/2	33,5	14,0	14,0	22	50
1021234	G1/2	G3/4	37,5	16,5	14,0	27	25
1023434	G3/4	G3/4	40,0	16,5	16,5	27	25
1023401	G3/4	G1'	42,5	19,0	16,5	34	10
1020101	G1'	G1'	45,0	19,0	19,0	34	10

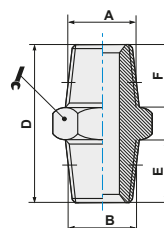
ART. 102P3

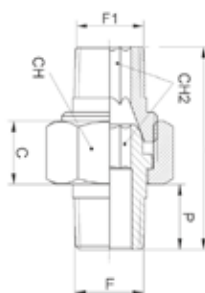

 Nipplo conico 3 pezzi
Nipple (taper) - 3 pieces

CODICE	F	F1	CH	CH2	P	L	C	Gr	
10218P3	1/8	1/8	15	5	9,0	27,0	8,6	18,5	50
10214P3	1/4	1/4	19	6	11,5	33,5	9,6	36,0	50
10238P3	3/8	3/8	22	8	13,0	36,0	10,0	66,0	50
10212P3	1/2	1/2	27	12	15,5	45,0	12,0	88,0	25
10234P3	3/4	3/4	36	14	18,0	53,0	17,0	200,0	25
10201P3	1"	1"	46	19	22,0	64,0	20,0	360,0	5
1021814P3	1/8	1/4	15	5	9,0	30,0	8,5	24,0	50
1021438P3	1/4	3/8	19	6	11,5	36,0	9,5	45,5	50
1023812P3	3/8	1/2	22	8	13,0	39,0	10,0	76,0	25



ART. 103

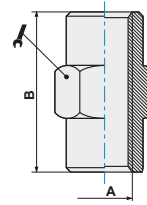

Manicotto filettato
Sleeve

CODICE	A	B					
103M5	M5	11				8	100
10318	G1/8	15				14	100
10314	G1/4	22				17	100
10338	G3/8	23				22	50
10312	G1/2	30				26	25
10334	G3/4	32				32	10



ART. 104

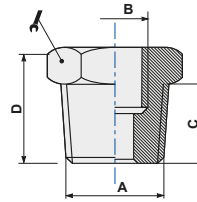

Riduzione M/F conica
Taper reducer

CODICE	A	B	C	D			
1041418	G1/4	G1/8	11,0	16,0		14	100
1043818	G3/8	G1/8	11,5	16,5		17	100
1041218	G1/2	G1/8	14,0	19,5		22	50
1043814	G3/8	G1/4	11,5	16,5		17	100
1041214	G1/2	G1/4	14,0	19,5		22	50
1041238	G1/2	G3/8	14,0	19,5		22	50
1043412	G3/4	G1/2	16,5	23,0		27	25
1043438	G3/4	G3/8	16,5	23,0		27	10
1040112	G1'	G1/2	17,0	25,0		34	10
1040134	G1'	G3/4	17,0	25,0		34	10



ART. 104Z

Riduzione M/F cilindrica
Parallel reducer

CODICE	A	B	C	D			
104Z18M5	G1/8	M5	6,0	10,5		14	100
104Z1418	G1/4	G1/8	8,0	13,0		17	100
104Z3818	G3/8	G1/8	9,0	14,0		19	100
104Z3814	G3/8	G1/4	9,0	14,0		19	100
104Z1218	G1/2	G1/8	10,0	15,5		24	50
104Z1214	G1/2	G1/4	10,0	15,5		24	50
104Z1238	G1/2	G3/8	10,0	15,5		24	50
104Z3412	G3/4	G1/2	12,5	18,0		30	25
104Z3438	G3/4	G3/8	12,5	18,0		30	10

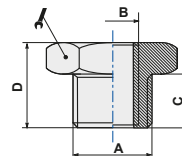

ART. 104S

 Riduzione cilindrica a scomparsa
Disapperance parallel reducer

CODICE	F	F1	H	H1		
104S1418	1/4	1/8	8	7	6	50
104S3814	3/8	1/4	9	7	8	50
104S1238	1/2	3/8	10	9	10	25
104S3412	3/4	1/2	14	11	12	10
104S0134	1"	3/4	20	12,5	17	10

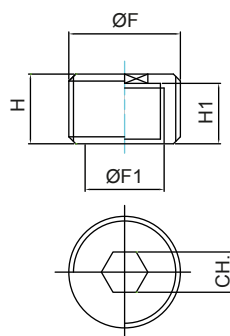
ART. 105

 Prolunga M/F conica
Taper M/F extension

CODICE	A	B	C	D	E		
1051818	G1/8	G1/8	8,0	18,0	8,0	14	100
1051814	G1/8	G1/4	8,0	21,5	11,0	17	100
1051838	G1/8	G3/8	8,0	22,5	11,5	22	50
1051414	G1/4	G1/4	11,0	24,5	11,0	17	100
1051438	G1/4	G3/8	11,0	24,5	11,5	22	50
1051412	G1/4	G1/2	11,0	29,0	14,0	24	50
1053838	G3/8	G3/8	11,5	26,0	11,5	22	50
1053812	G3/8	G1/2	11,5	29,5	14,0	24	25
1051212	G1/2	G1/2	14,0	32,0	14,0	26	25
1051234	G1/2	G3/4	14,0	35,0	16,5	32	10
1051201	G1/2	G1	14,0	37,0	18,0	38	10

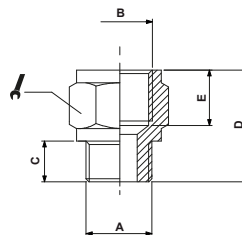
ART. 105Z

 Prolunga M/F cilindrica
Parallel M/F extension

CODICE	A	B	C	D	E		
105ZM5M5	M5	M5	5	14,0	7,0	9	100
105ZM518	M5	G1/8	4	14,5	8,0	14	100
105ZM618	M6	G1/8	6	16,0	8,0	14	100
105Z1818	G1/8	G1/8	6	16,0	8,0	14	100
105Z1814	G1/8	G1/4	6	19,5	11,0	17	100
105Z1838	G1/8	G3/8	6	20,5	11,5	22	50
105Z1414	G1/4	G1/4	8	21,5	11,0	17	100
105Z1438	G1/4	G3/8	8	22,5	11,5	22	50
105Z1412	G1/4	G1/2	8	26,0	14,0	24	50
105Z3838	G3/8	G3/8	9	23,5	11,5	22	50
105Z3812	G3/8	G1/2	9	27,0	14,0	24	25
105Z1212	G1/2	G1/2	10	28,0	14,0	26	25
105Z1234	G1/2	G3/4	10	30,0	16,5	32	10

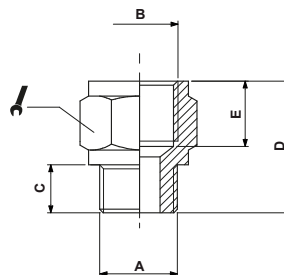

ART. 105P3 Prolunga M/F - 3 pezzi
Extension M/F - 3 pieces

CODICE	F	CH	CH1	CH2	P	P1	L	C	Gr	
10518P3	1/8	14	15	5	9,0	10,0	30,5	8,5	19,0	50
10514P3	1/4	17	19	6	12,0	12,0	37,0	9,5	39,0	50
10538P3	3/8	21	22	8	12,0	12,0	40,0	10,0	68,0	25
10512P3	1/2	25	27	12	15,0	15,0	48,0	12,0	118,0	10



ART. 106 Manicotto riduzione
Reducing sleeve

CODICE	A	B	C		
106M518	M5	G1/8	13,5	14	100
1061814	G1/8	G1/4	19,0	17	100
1061838	G1/8	G3/8	20,0	22	25
1061812	G1/8	G1/2	24,0	26	50
1061438	G1/4	G3/8	23,0	22	50
1061412	G1/4	G1/2	25,0	26	50
1063812	G3/8	G1/2	27,5	26	25
1061234	G1/2	G3/4	30,0	32	10

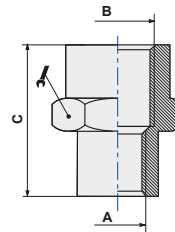

ART. 107 Tappo maschio cilindrico con O-Ring
Parallel male plug + O-Ring

CODICE	A	P	L	ØE		
107M5	M5	4,0	5,5	8	2,5	100
10718	G1/8	5,5	7,5	14	4,0	100
10714	G1/4	6,5	8,5	17	6,0	100
10738	G3/8	7,5	10,5	20	8,0	100
10712	G1/2	9,0	12,0	24	10,0	50
10734	G3/4	15,0	20,0	32	12,0	10

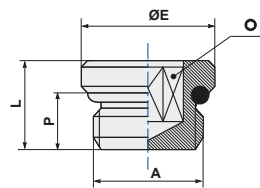

ART. 107P Tappo maschio cilindrico con OR (Tecnopolimero)
Parallel male plug + OR (Technopolymer)

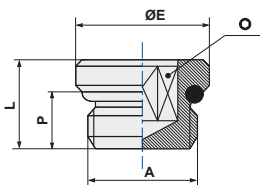

CODICE	A	P	L	ØE	Nm		
107P18	G1/8	5,3	8,2	14	1,2*	4	100
107P14	G1/4	6,5	9,2	18	1,5*	6	100



(*) = coppie di serraggio *tightening torque*



ART. 107Z

 Tappo maschio cilindrico
Parallel male plug

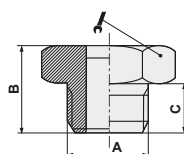
CODICE	A	B	C				
107Z18	G1/8	10,5	6			14	100
107Z14	G1/4	13,0	8			17	100
107Z38	G3/8	14,0	9			19	50
107Z12	G1/2	15,5	10			24	50
107Z34	G3/4	16,5	11			30	25
107Z01	G1"	19,0	13			38	10



ART. E100

 Tappo a scomparsa conico
Disappearance tapered plug

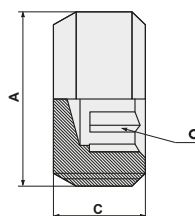
CODICE	A	C			
E10018	G1/8	8		5	100
E10018L5	G1/8	5		5	100
E10014	G1/4	10		6	100
E10038	G3/8	11		8	50
E10012	G1/2	13		10	50



ART. E200

 Tappo a scomparsa cilindrico
Disappearance parallel plug

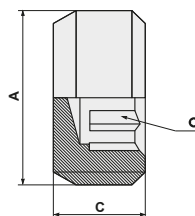
CODICE	A	C			
E20018	G1/8	8		5	100
E20014	G1/4	10		6	100
E20038	G3/8	11		8	50
E20012	G1/2	13		10	50

ART. 108

 Tappo femmina
Female plug

CODICE	A	C	H			
10818	G1/8	8,0	10,0		14	100
10814	G1/4	11,0	13,5		17	100
10838	G3/8	11,5	14,0		20	50
10812	G1/2	14,0	16,5		24	50

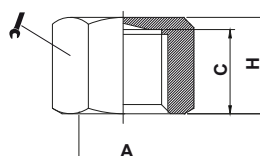

ART. 109

Elle F.F.
Female L

CODICE	A	B	C				
10918	G1/8	7	20,0			10	100
10914	G1/4	8	25,5			13	50
10938	G3/8	10	29,0			17	25
10912	G1/2	11	35,0			20	10
10934	G3/4	16	36,0			25	5
10901	G1'	19	44,0			30	5

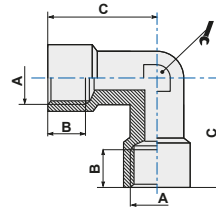

ART. 110

Elle M.F.
Male-Female L

CODICE	A	A1	B	B1	C	D		
110M5	M5	M5	4		11,0	11,5	9	100
11018	G1/8	G1/8	7	8	20,0	19,0	10	50
11014	G1/4	G1/4	8	11	25,5	24,0	13	50
11038	G3/8	G3/8	10	11,5	29,0	26,5	17	25
11012	G1/2	G1/2	11	14	35,0	31,5	20	20
11034	G3/4	G3/4	16	16	35,0	34,5	25	10
11001	G1'	G1'	19	16	44,0	51,0	30	5
11014F18M	G1/8	G1/4	8	8	25,5	23,0	13	50

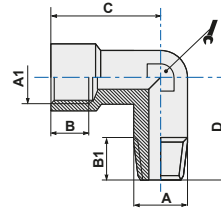

ART. 111

T F.F.F.
Female T

CODICE	A	B	C	D		
11118	G1/8	7	20,0	40	10	50
11114	G1/4	8	25,5	51	13	25
11138	G3/8	10	29,0	58	17	10
11112	G1/2	11	35,0	70	20	10
11134	G3/4	16	31,0	73	25	5
11101	G1'	19	49,5	90	30	5

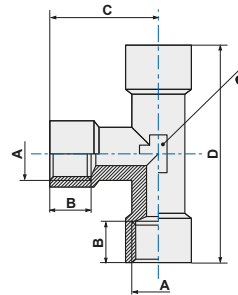

ART. 112

T F.M.F.
Centre male T

CODICE	A	B	B1	C	D		
11218	G1/8	7	8,0	19,0	40	10	50
11214	G1/4	8	11,0	24,0	51	13	25
11238	G3/8	10	13,6	26,5	58	17	25
11212	G1/2	11	15,5	31,5	72	20	10
11234	G3/4	16	15,0	31,0	73	25	5
11201	G1'	19	16,0	38,0	90	30	5

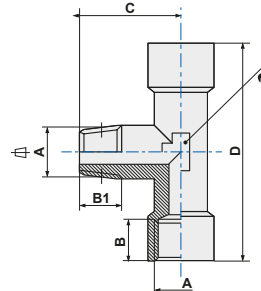

ART. 113

 T M.F.F.
Off-set male T

CODICE	A	B	B1	C	D		
11318	G1/8	7	8,0	20,0	39,0	10	50
11314	G1/4	8	11,0	25,5	49,5	13	25
11338	G3/8	10	13,6	29,0	55,5	17	25
11312	G1/2	11	15,5	35,0	65,0	20	10
11334	G3/4	16	15,0	31,0	67,0	25	5
11301	G1"	19	16,0	44,0	84,0	30	5

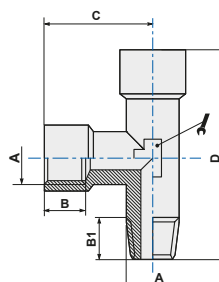
ART. 114

 Croce F.F.F.F.
Female cross

CODICE	A	B	C				
11418	G1/8	7	40			10	25
11414	G1/4	8	51			13	25
11438	G3/8	10	58			17	10
11412	G1/2	11	72			20	5

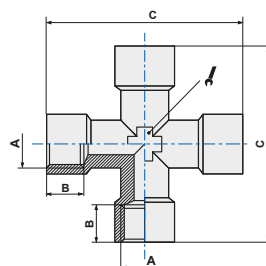
ART. 115

 Elle M.M.
Male L

CODICE	A	B	C	A1	B1		
11518	G1/8	8,0	19,0	G1/8	8,0	10	100
11514	G1/4	12,5	24,0	G1/4	12,5	13	50
11538	G3/8	13,6	26,5	G3/8	26,5	17	25
11512	G1/2	15,5	31,5	G1/2	15,5	20	25
11534	G3/4	15,0	35,5	G3/4	15,0	25	5
11501	G1"	16,0	51,0	G1"	51,0	30	5
1151814	G1/8	8,0	22,0	G1/4	12,5	13	100

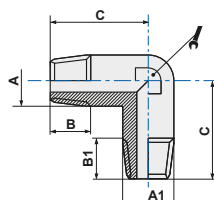

ART. 116

T M.M.M.
Male T

CODICE	A	B	C	D			
11618	G1/8	8,0	19,0	38		10	100
11614	G1/4	12,5	24,0	48		13	50
11638	G3/8	13,6	26,5	53		17	25
11612	G1/2	15,5	31,5	63		20	10
11634	G3/4	15,0	35,5	66		25	5
11601	G1"	16,0	40,5	78		30	5

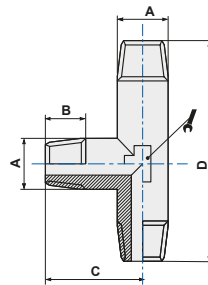

ART. 117

T M.F.M.
Centre female T

CODICE	A	B	B1	C	D			
11718	G1/8	7	8,0	20,0	38		10	100
11714	G1/4	8	12,5	25,5	48		13	50
11738	G3/8	10	13,6	29,0	53		17	25
11712	G1/2	11	15,5	36,0	63		17	10
11734	G3/4	16	15,0	34,5	66		25	5
11701	G1"	19	16,0	46,5	78		30	5

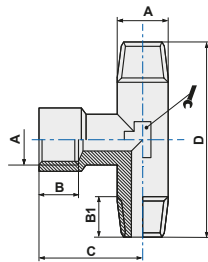

ART. 118

T M.M.F.
Off-set female T

CODICE	A	B	C	D			
11818	G1/8	8,0	19,0	39,0		10	100
11814	G1/4	12,5	24,0	49,5		13	50
11838	G3/8	13,6	26,5	55,5		17	25
11812	G1/2	15,5	31,5	67,5		20	10
11834	G3/4	15,0	34,5	69,0		25	5
11801	G1"	16,0	38,0	84,0		30	5

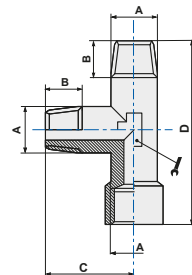

ART. 119

 Portagomma maschio con O-Ring
 Male hose adapter + O-Ring

CODICE	ØD	A	I	H	Ød		
11945M5	4,5	M5	4	31,5	2,2	11	100
1190718	7	G1/8	6	31,5	4	13	100
1190714	7	G1/4	8	34,0	4	16	100
1190818	8	G1/8	6	31,5	5,30	13	100
1190918	9	G1/8	6	31,5	5,5	13	100
1190914	9	G1/4	8	34,0	5,5	16	100
1190938	9	G3/8	9	35,0	5,5	17	50
1191014	10	G1/4	8	34,0	6	16	50
1191038	10	G3/8	9	35,0	6	17	50
1191214	12	G1/4	8	34,0	8	16	50
1191238	12	G3/8	9	36,0	8	17	50
1191212	12	G1/2	11	37,0	8	22	50
1191738	17	G3/8	9	36,0	11	17	50
1191712	17	G1/2	11	37,0	12	22	50

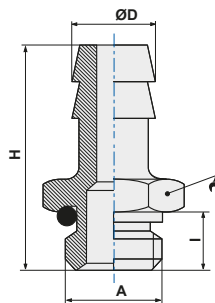
ART. 119Z

 Portagomma maschio cilindrico
 Male hose adapter

CODICE	ØD	A	I	H	H1	Ød		
119Z04M5	4,5	M5	4	22,5	15,0	2	8	100
119Z0618	6	G1/8	6	29,5	19,0	3	12	100
119Z0614	6	G1/4	8	32,0	19,0	3	14	100
119Z0718	7	G1/8	6	29,5	19,0	4	12	100
119Z0714	7	G1/4	8	32,0	19,0	4	14	100
119Z0818	8	G1/8	6	29,5	19,0	5	12	100
119Z0814	8	G1/4	8	32,0	19,0	5	14	100
119Z0838	8	G3/8	9	33,0	19,0	5	19	100
119Z0918	9	G1/8	6	29,5	19,0	6	12	100
119Z0914	9	G1/4	8	32,0	19,0	6	14	100
119Z0938	9	G3/8	9	33,0	19,0	6	19	100
119Z0912	9	G1/2	10	35,5	19,0	6	24	25
119Z1018	10	G1/8	6	30,5	20,0	7	12	100
119Z1014	10	G1/4	8	33,0	20,0	7	14	50
119Z1038	10	G3/8	9	34,0	20,0	7	19	100
119Z1012	10	G1/2	10	36,0	20,0	7	24	50
119Z1214	12	G1/4	8	33,0	20,0	9	14	50
119Z1238	12	G3/8	9	34,0	20,0	9	19	50
119Z1212	12	G1/2	10	35,5	20,0	9	22	50
119Z1414	14	G1/4	8	33,0	20,0	10	14	25
119Z1438	14	G3/8	9	36,0	22,0	10,5	19	50
119Z1412	14	G1/2	10	37,5	22,0	10,5	22	50
119Z1638	16	G3/8	9	38,0	24,0	12	19	50
119Z1612	16	G1/2	10	38,0	22,0	12,5	24	25
119Z1738	17	G3/8	9	38,0	24,0	13	19	50
119Z1712	17	G1/2	10	39,5	24,0	13	22	50
119Z2012	20	G1/2	10	39,5	24,0	14	24	25
119Z2034	20	G3/4	10	39,5	24,0	16	24	25

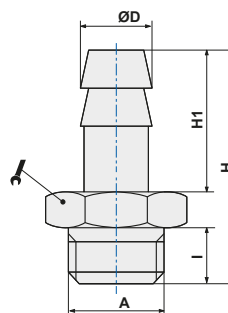

ART. 120 Croce M.F.F.F.
1 male 3 female cross

CODICE	A	B	B1	C	D		
12018	G1/8	7	8,0	19,0	40	10	25
12014	G1/4	8	12,5	24,0	51	13	25
12038	G3/8	10	13,6	26,5	58	17	10
12012	G1/2	11	15,5	31,5	72	20	5

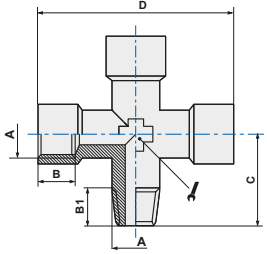

ART. 122 Portagomma femmina
Female hose adapter

CODICE	ØD	F	Ød	I	H	H1		
1220618	6	G1/8	3,5	8	28,5	19	12	100
1220718	7	G1/8	4,5	8	28,5	19	12	100
1220714	7	G1/4	4,5	11	31,5	19	15	100
1220818	8	G1/8	5,5	8	28,5	19	12	100
1220814	8	G1/4	5,5	11	31,5	19	15	100
1220914	9	G1/4	6,5	11	31,5	19	15	100
1221014	10	G1/4	7,5	11	32,5	20	15	50
1221038	10	G3/8	7,5	11,5	33	20	19	25
1221238	12	G3/8	9,5	11,5	33	20	19	25
1221212	12	G1/2	9,5	14	36	20	24	10
1221438	14	G3/8	11	11,5	35	22	19	10
1221412	14	G1/2	11	14	38	22	24	10

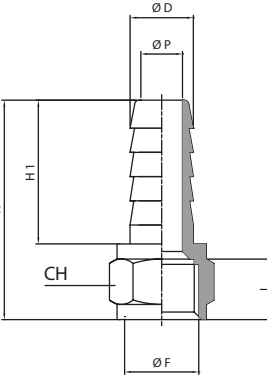

ART. 123 Prolunga
Extension

CODICE	A	A1	B	C	D		
12318L22	G1/8	G1/8	6	22	16	14	100
12318L32	G1/8	G1/8	6	32	26	14	100
12318L42	G1/8	G1/8	6	42	36	14	100
12318L51	G1/8	G1/8	6	51	45	14	50
12314L28	G1/4	G1/4	8	28	20	17	50
12314L35	G1/4	G1/4	8	35	27	17	50
12314L51	G1/4	G1/4	8	51	43	17	25

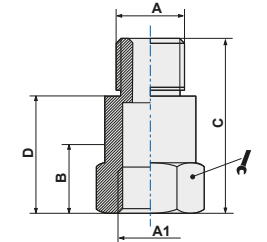

ART. 125 Y maschio
Male Y

CODICE	A	B				
12518	G1/8	8,0			13	50
12514	G1/4	11,0			17	25
12538	G3/8	11,5			20	25
12512	G1/2	14,0			25	10

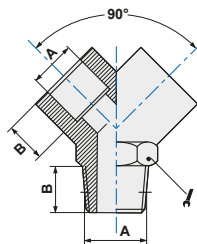
ART. 126 Y femmina
Female Y

CODICE	A	B				
12618	G1/8	8			13	50
12614	G1/4	11			17	25
12638	G3/8	11			20	25
12612	G1/2	14			25	10

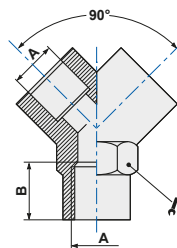
ART. 127 Passaparete femmina (nichelato)
Female bulkhead (nickel plated)

CODICE	G	A	B	C			
127M5	M5	M10x1,0	10,5	14	14	14	100
12718	G1/8	M16x1,5	14,0	18	22	19	50
12714	G1/4	M20x1,5	21,0	24	27	24	25
12738	G3/8	M26x1,5	21,0	26	32	30	25
12712	G1/2	M28x1,5	27,0	33	36	32	10

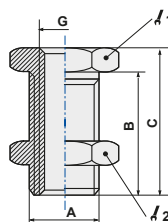
ART. RLB100 Raccordo ad "L" M/F conico
Male-female L tapered

CODICE	G	A	B	L1	L2		
RLB100M5	M5	9	4,5	9	4,5		100
RLB10018	1/8	14	6,5	14	8		100
RLB10014	1/4	18	9	18	10		100
RLB10038	3/8	19	11	19	11,5		50

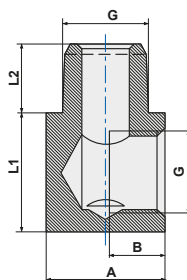

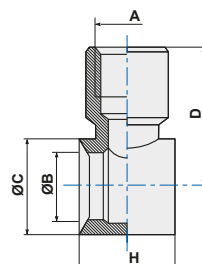

ART. 412 Anello singolo femmina
Female single banjo body

CODICE	A	ØB	ØC	D	H		
41218	G1/8	9,9	14	20	15		50
41214	G1/4	13,3	18	24	17		50
41238	G3/8	16,8	21	28,5	20		25
41212	G1/2	21	26	34,524			



ART. 201

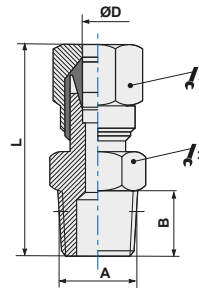

Raccordo diritto maschio conico
Taper straight male adaptor

CODICE	ØD	A	B	L			
2010418	4	G1/8	8	27	10	10	100
2010618	6	G1/8	8	28	12	12	100
2010614	6	G1/4	11	32,5	12	14	100
2010818	8	G1/8	8	29,5	14	12	100
2010814	8	G1/4	11	33	14	14	100
2010838	8	G3/8	11,5	33	14	17	50
2011014	10	G1/4	11	37,5	19	17	50
2011038	10	G3/8	11,5	38	19	17	50
2011012	10	G1/2	14	40,5	19	22	25
2011238	12	G3/8	11,5	39	22	19	25
2011212	12	G1/2	14	41	22	22	25
2011412	14	G1/2	14	42,5	27	22	25
2011512	15	G1/2	14	42,5	27	22	25
2011612	16	G1/2	14	42	30	24	10
2011812	18	G1/2	14	43	32	26	10



ART. 201Z

Raccordo diritto maschio cilindrico
Parallel straight male adaptor

CODICE	ØD	A	B	L			
201Z0418	4	G1/8	6	25	10	14	100
201Z0618	6	G1/8	6	26	12	14	100
201Z0614	6	G1/4	8	29,5	12	17	100
201Z0814	8	G1/8	6	27,5	14	14	100
201Z0818	8	G1/4	8	30	14	17	50
201Z0838	8	G3/8	9	30,5	14	19	50
201Z1014	10	G1/4	8	34,5	19	17	50

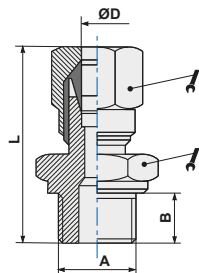

ART. 202

Raccordo diritto femmina
Female straight adaptor

CODICE	ØD	A	B	L				
2020418	4	G1/8	8	24,5		10	14	100
2020618	6	G1/8	8	26		12	14	100
2020614	6	G1/4	11	30,5		12	17	100
2020818	8	G1/8	8	26,5		14	14	50
2020814	8	G1/4	11	31		14	17	50
2020838	8	G3/8	11,5	31		14	20	50
2021014	10	G1/4	11	35,5		19	17	50
2021038	10	G3/8	11,5	36,5		19	20	25

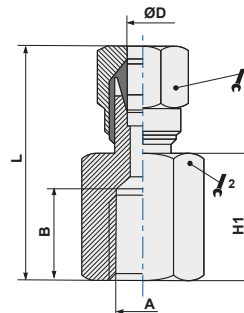

ART. 203

 Raccordo diritto intermedio
Straight connector

CODICE	ØD	L					
2030400	4	33,5			10	10	50
2030600	6	36,5			12	12	50
2030800	8	38,5			14	14	50
2031000	10	47,5			19	17	25
2031200	12	50,5			22	19	25
2031400	14	55,5			27	24	10
2031500	15	55,5			27	24	10

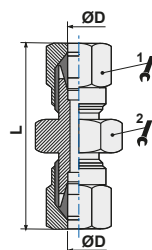
ART. 204

 Raccordo passaparete
Bulkhead adaptor

CODICE	ØD	L					
2040600	6	51,5			12	14	50
2040800	8	55,5			14	16	50
2041000	10	62,5			19	19	25
2041200	12	64,5			22	22	10
2041400	14	69,5			27	25	5
2041500	15	69,5			27	25	5

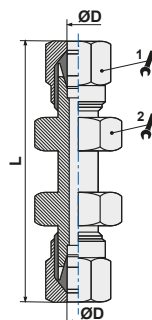
ART. 205

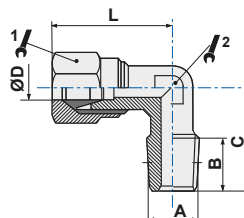

 Raccordo ad L
L male adaptor

CODICE	ØD	A	B	C	L				
2050418	4	G1/8	8	16	21		10	9	100
2050618	6	G1/8	8	16	22		12	9	100
2050614	6	G1/4	11	20	24,5		12	11	100
2050818	8	G1/8	8	17	24		14	11	100
2050814	8	G1/4	11	20	24		14	11	100
2050838	8	G3/8	11,5	24	27		14	13	50
2051014	10	G1/4	11	23,5	32		19	13	50
2051038	10	G3/8	11,5	24	32		19	13	25
2051012	10	G1/2	14	28,5	34		19	15	25
2051238	12	G3/8	11,5	25,5	34,5		22	15	25
2051212	12	G1/2	14	28,5	34,5		22	15	25
2051412	14	G1/2	14	30	38		27	17	25
2051512	15	G1/2	14	30	38		27	17	10
2051612	16	G1/2	14	31,5	39,5		30	19	10
2051812	18	G1/2	14	34	44		32	22	10



ART. 206

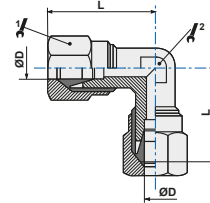

Raccordo ad L intermedio
L connector

CODICE	ØD	L						
2060400	4	21				10	9	100
2060600	6	23				12	9	50
2060800	8	24				14	11	50
2061000	10	32				19	13	25
2061200	12	34,5				22	15	10
2061400	14	38				27	17	10
2061500	15	38				27	17	10
2061600	16	39,5				30	19	10



ART. 207

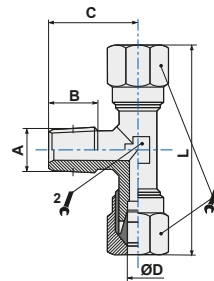

Raccordo a T centrale
Centre male T adaptor

CODICE	ØD	A	B	C	L				
2070418	4	G1/8	8	16	42		10	9	100
2070618	6	G1/8	8	16	46		12	9	50
2070614	6	G1/4	11	20	48		12	11	50
2070818	8	G1/8	8	17	48		14	11	50
2070814	8	G1/4	11	20	48		14	11	25
2070838	8	G3/8	11,5	24	54		14	13	25
2071014	10	G1/4	11	23,5	64		19	13	25
2071038	10	G3/8	11,5	24	64		19	13	25
2071238	12	G3/8	11,5	25,5	69		22	15	10
2071212	12	G1/2	14	28,5	69		22	15	10



ART. 208

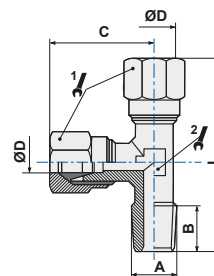

Raccordo a T laterale
Off-set male T adaptor

CODICE	ØD	A	B	C	L				
2080418	4	G1/8	8	37	21		10	9	100
2080618	6	G1/8	8	39	23		10	9	50
2080614	6	G1/4	11	44,5	24,5		12	11	50
2080818	8	G1/8	8	41	24		14	11	50
2080814	8	G1/4	11	44	24		14	11	25
2080838	8	G3/8	11,5	51	27		14	13	25
2081014	10	G1/4	11	55,5	32		19	13	25
2081038	10	G3/8	11,5	56	32		19	13	25
2081238	12	G3/8	11,5	60	34,5		22	15	10
2081212	12	G1/2	14	63	34,5		22	15	10



ART. 209

Raccordo a T intermedio
T connector

CODICE	ØD	C	L					
2090400	4	21	42			10	9	50
2090600	6	23	46			12	9	50
2090800	8	24	48			14	11	25
2091000	10	32	64			19	13	25
2091200	12	34,5	69			22	15	10

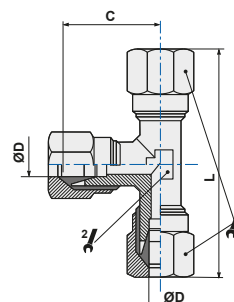

ART. 210

 Dado
Nut

CODICE	ØD	A	H				
2100400	4	M8x1	11			10	100
2100600	6	M10x1	11,5			12	100
2100800	8	M12x1	12			14	100
2101000	10	M16x1,5	15,5			19	100
2101200	12	M18x1,5	15,5			22	100
2101400	14	M22x1,5	17,5			27	10
2101500	15	M22x1,5	17			27	10
2101600	16	M24x1,5	17,5			30	10
2101800	18	M26x1,5	18,5			32	10

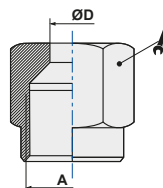
ART. 211

 Ogiva
Ogive

CODICE	ØD	ØD1	H				
2110400	4	6	6				100
2110600	6	8	7				100
2110800	8	10	7				100
2111000	10	13	10				100
2111200	12	15	10				100
2111400	14	17	10				100
2111500	15	18	10				100
2111600	16	19	10				100
2111800	18	21	10,5				100

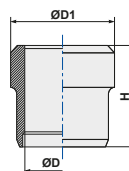
ART. 212

 Boccia di supporto
Support bush

CODICE	ØD	ØD1	H				
2120200	2	3,5	8				100
2120250	2,5	3,9	10				100
2120400	4	5,5	12				100
2120600	6	7,5	13				100
2120800	8	9,5	14				100
2121000	10	11,5	16				100
2121200	12	13,5	16				100
2121250	12,5	14,5	17				100
2121400	14	15,5	18				100

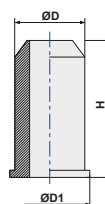
ART. 216

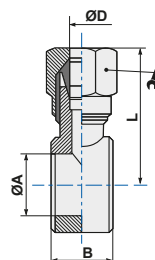

 Raccordo ad L orientabile
Single banjo body

CODICE	ØD	G*	ØA	B	L		
2160418	4	1/8	9,8	14,5	24,5	10	50
2160618	6	1/8	9,8	14,5	26,5	12	50
2160614	6	1/4	13,2	14,5	28,5	12	50
2160818	8	1/8	9,8	14,5	25,5	14	50
2160814	8	1/4	13,2	14,5	28	14	50
2161014	10	1/4	13,3	14,5	32	17	25

 (*) G = filetto vite/asta
 (*) G = steam thread

ART. 301

Raccordo diritto maschio conico
Taper straight male adaptor

CODICE	ØD	F	I	H			
3010418	4/2,7	G1/8	8	25,5	9	12	100
3010518	5/3	G1/8	8	25	8	12	100
3010618	6/4	G1/8	8	26,5	12	12	100
3010614	6/4	G1/4	11	30	12	14	100
3010638	6/4	G3/8	11,5	30,5	12	17	100
3010818	8/6	G1/8	8	26,5	14	12	100
3010814	8/6	G1/4	11	30	14	14	100
3010838	8/6	G3/8	11,5	30,5	14	17	50
3010812	8/6	G1/2	14	33,5	14	22	50
3011018	10/8	G1/8	8	29	16	14	50
3011014	10/8	G1/4	11	32	16	14	50
3011038	10/8	G3/8	11,5	32,5	16	17	50
3011012	10/8	G1/2	14	35,5	16	22	50
3011238	12/10	G3/8	11,5	35,5	18	17	50
3011212	12/10	G1/2	14	38,5	18	22	25
3011512	15/12,5	G1/2	14	40	22	22	25

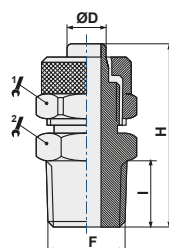

ART. 301Z

Raccordo diritto maschio cilindrico
Parallel straight male adaptor

CODICE	ØD	F	I	H			
301Z0418	4/2,7	G1/8	6	21,5	8	13	100
301Z05M5	5/3	M5	4	20	8	8	100
301Z05M6	5/3	M6	4	22,1	8	8	100
301Z0518	5/3	G1/8	6	24,1	8	13	100
301Z06M5	6/4	M5	3,8	21,8	8	8	100
301Z0618	6/4	G1/8	6	24,5	12	14	100
301Z0614	6/4	G1/4	8	27	12	17	100
301Z0638	6/4	G3/8	9	28	12	19	50
301Z0818	8/6	G1/8	6	24,5	14	14	100
301Z0814	8/6	G1/4	8	27	14	17	50
301Z0838	8/6	G3/8	9	28	14	19	50
301Z1014	10/8	G1/4	8	29	16	17	50
301Z1038	10/8	G3/8	9	30	16	19	25
301Z1238	12/10	G3/8	9	33	18	19	25
301Z1212	12/10	G1/2	10	35	18	24	25
301Z1512	15/12,5	G1/2	10	35	22	24	25

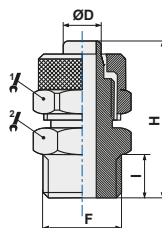

ART. TC

 Raccordo diritto maschio cilindrico (compatto)
Parallel straight male adaptor (compact)

CODICE	ØD	ØF	I	L	H			
TC04M5	4	M5x0,8	4	17,0	8			100
TC0418	4	G1/8	5,5	20,0	14			100
TC06M5	6	M5x0,8	4	20,8	10			100
TC06M6	6	M6x1	4	20,8	10			100
TC0618	6	G1/8	5,5	23,0	14			100

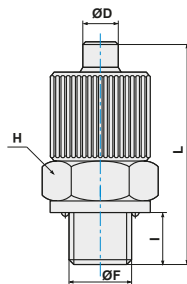
 Di importazione
Imported

ART. 302

 Raccordo diritto femmina
Straight female adaptor

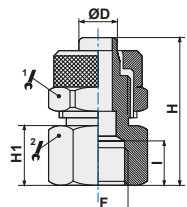
CODICE	ØD	F	I	H	H1			
3020618	6/4	G1/8	8	25	10	12	14	100
3020614	6/4	G1/4	11	29	14	12	17	100
3020638	6/4	G3/8	11,5	29,5	14,5	12	22	50
3020818	8/6	G1/8	8	25	10	14	14	100
3020814	8/6	G1/4	11	29	14	14	17	100
3020838	8/6	G3/8	11,5	29,5	14,5	14	22	50
3021014	10/8	G1/4	11	30,5	14	16	17	50
3021038	10/8	G3/8	11,5	31	14,5	16	22	50
3021238	12/10	G3/8	11,5	32,5	14,5	18	22	50

ART. 303

 Raccordo diritto intermedio
Straight connector

CODICE	ØD	L					
3030500	5/3	28,5			8	8	100
3030600	6/4	32			12	12	100
3030800	8/6	32			14	12	100
3031000	10/8	37			16	14	50
3031200	12/10	43			18	17	50
3031500	15/12,5	46,5			22	22	25

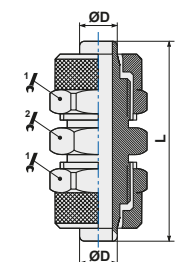
ART. 304

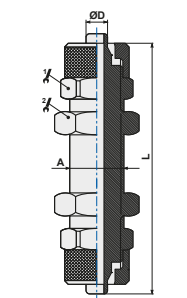

 Raccordo intermedio passaparete
Bulkhead connector

CODICE	ØD	A	L				
3040600	6/4	M10x1	45		12	14	100
3040800	8/6	M12x1	48		14	17	50
3041000	10/8	M14x1	54		16	17	50
3041200	12/10	M16x1	57		18	19	25
3041500	15/12,5	M20x1	59		22	24	10



ART. 305

Raccordo ad L maschio conico
L taper male adaptor

CODICE	ØD	F	I	H	L			
30504M5	4/2	M5	8	13	20,0	9	9	100
3050418	4/2	G1/8	8	17	20,0	9	9	100
3050518	5/3	G1/8	8	17	21,5	8	8	100
3050618	6/4	G1/8	8,5	17	20,5	12	10	100
3050614	6/4	G1/4	12,5	21	20,5	12	8	100
3050638	6/4	G3/8	15,5	23	20,5	12	8	50
3050818	8/6	G1/8	8	17	20,5	14	10	100
3050814	8/6	G1/4	12,5	21,5	20,5	14	10	100
3050838	8/6	G3/8	15,3	23,8	20,5	14	10	50
3051018	10/8	G1/8	8	17	24,5	16	12	50
3051014	10/8	G1/4	12,5	22	24,5	16	12	50
3051038	10/8	G3/8	14,8	24,3	24,5	16	12	50
3051012	10/8	G1/2	14	28	28	16	17	25
3051238	12/10	G3/8	14	26	29	18	14	50
3051212	12/10	G1/2	16	28	29	18	14	25
3051512	15/12,5	G1/2	15	28	24	22	16	25

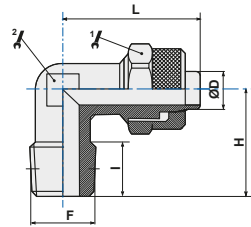

ART. TL

Raccordo ad L maschio cilindrico
Elbow parallel male adaptor

CODICE	ØD	ØF	I	H	L1	
TL04M5	4	M5x0,8	4,0	13,0	13,5	50
TL0418	4	G1/8	5,0	19,5	16,5	50
TL06M5	6	M5x0,8	4,9	13,9	16,3	50
TL06M6	6	M6x1	4,0	14,2	17,5	50
TL0618	6	G1/8	5,0	19,5	19,3	50

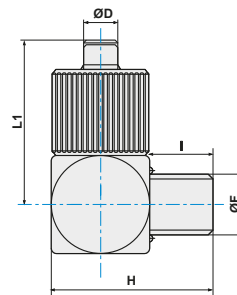

Di importazione
Imported

ART. 305F

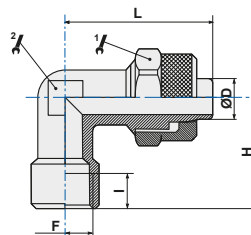

Raccordo ad L femmina
Female L adaptor

CODICE	ØD	F	I	H	L			
305F0618	6/4	G1/8	7	20,5	20,5	12	10	100
305F0614	6/4	G1/4	8	22,5	20,5	12	12	50
305F0818	8/6	G1/8	7	20,5	20,5	14	10	100
305F0814	8/6	G1/4	8	23,5	20,5	14	11	50
305F1014	10/8	G1/4	8	24	24,5	16	13	50
305F1038	10/8	G3/8	10	27	24,5	16	17	25
305F1238	12/10	G3/8	10	29	29	18	14	25



ART. 306

Raccordo ad L intermedio
L connector

CODICE	ØD	L			
3060600	6/4	20,5	12	8	100
3060800	8/6	20,5	14	10	100
3061000	10/8	24,5	16	11	50
3061200	12/10	29	18	14	25
3061500	15/12,5	34	22	16	25

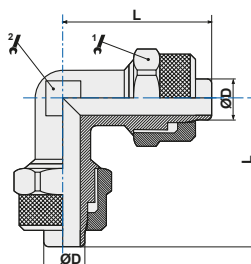

ART. 307
Raccordo T centrale
Central T adaptor

CODICE	ØD	F	I	H	L			
3070618	6/4	G1/8	8,5	17	41	12	8	100
3070614	6/4	G1/4	13	21,5	41	12	8	50
3070818	8/6	G1/8	8	16,5	41	14	10	50
3070814	8/6	G1/4	12,5	21	41	14	10	50
3070838	8/6	G3/8	15,3	23,8	41	14	10	25
3071018	10/8	G1/8	8	18,5	49	16	12	50
3071014	10/8	G1/4	11,8	22,3	49	16	12	50
3071038	10/8	G3/8	14,7	25,2	49	16	12	25
3071238	12/10	G3/8	14,1	26	58	18	14	25
3071212	12/10	G1/2	15	27	58	18	14	25
3071512	15/12,5	G1/2	14,4	27,4	68	22	16	10

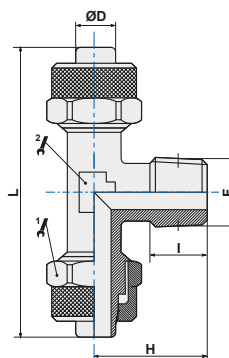
ART. 308
Raccordo T laterale
Off-set T adaptor

CODICE	ØD	F	I	L	H			
3080618	6/4	G1/8	8,5	20,5	37,5	12	8	100
3080614	6/4	G1/4	13	20,5	42	12	8	50
3080818	8/6	G1/8	8	20,5	37	14	10	50
3080814	8/6	G1/4	12,5	20,5	41,5	14	10	50
3080838	8/6	G3/8	15,3	20,5	44,3	14	10	25
3081018	10/8	G1/8	8	25,5	44	16	12	50
3081014	10/8	G1/4	11,8	24,5	46,8	16	12	50
3081038	10/8	G3/8	14,7	24,5	49,7	16	12	25
3081238	12/10	G3/8	14,1	29	55,1	18	14	25
3081212	12/10	G1/2	15	29	56	18	14	25
3081512	15/12,5	G1/2	14,4	34	61,4	22	16	10

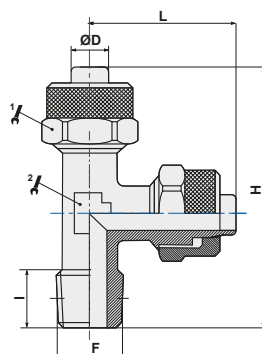

ART. 309
Raccordo T intermedio
T connector

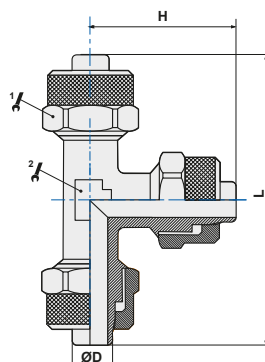
CODICE	ØD	H	L			
3090600	6/4	20,5	41	12	8	50
3090800	8/6	20,5	41	14	10	50
3091000	10/8	24,5	49	16	12	25
3091200	12/10	29	58	18	14	25
3091500	15/12,5	34	68	22	17	10



ART. 310

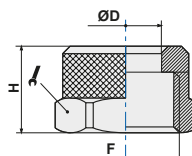

Dado di serraggio
Locking nut

CODICE	ØD	F	H		
3100400	4/2,7	M7x0,75	8,1	9	100
3100500	5/3	M7x0,75	8,5	8	100
3100608	6/4	M8x0,75	9	9	100
3100610	6/4	M10x1	10,5	12	100
3100800	8/6	M12x1	10,5	14	100
3101000	10/8	M14x1	11,5	16	100
3101200	12/10	M16x1	13	18	100
3101500	15/12,5	M20x1	15,5	22	50



ART. 311

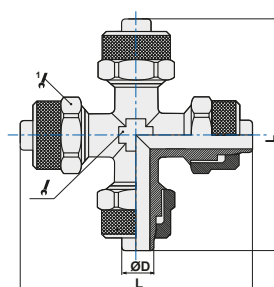

Raccordo a croce intermedio
Cross adaptor

CODICE	ØD	L			
3110600	6/4	41	8	12	50
3110800	8/6	41	10	14	25
3111000	10/8	49	12	16	25



ART. 405

Anello singolo
Single banjo body

CODICE	ØD	G*	H	L		
40504M5	4/2	M5	9	16,5	8	100
4050418	4/2,7	G1/8	9	16,5	8	100
40506M5	6/4	M5	9	18	9	100
4050618	6/4	G1/8	15	23,5	12	100
4050614	6/4	G1/4	17	25,5	12	100
4050818	8/6	G1/8	15	22,5	14	100
4050814	8/6	G1/4	17	24,5	14	50
4051014	10/8	G1/4	17	25,5	14	50

(*) G = Filetto vite/asta
(*) G = Steam thread

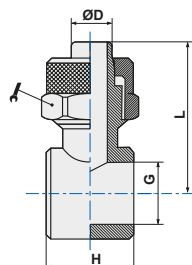

ART. 406

Anello doppio
Double banjo body

CODICE	ØD	G*	H	L		
4060618	6/4	G1/8	15	47	12	100
4060614	6/4	G1/4	14,5	51	12	50
4060818	8/6	G1/8	14,5	45	14	50
4060814	8/6	G1/4	14,5	49	14	50
4061014	10/8	G1/4	14,5	51	16	50

(*) G = Filetto vite/asta
(*) G = Steam thread

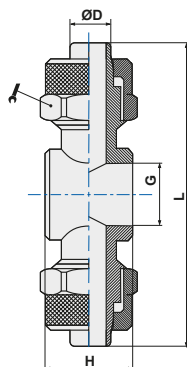

BREVE DESCRIZIONE

I raccordi di linea della nostra serie **100**, sono realizzati in Italia, a garanzia di elevati standard di qualità, secondo le normative ISO di riferimento, e rispondono alle seguenti specifiche tecniche e applicative.

SHORT DESCRIPTION

The standard 100 series fittings are produced in Italy according to the reference ISO norms as warranty of high quality level and answer to the followings technical specifications and applications.

SCHEDA TECNICA TECHNICAL SHEET

FLUIDI UTILIZZABILI <i>EMPLOYABLE FLUIDS</i>		Aria compressa, acqua fino 100 °C (per altri fluidi contattare il nostro UT) <i>Compressed air, water up to 100 °C (for different fluid pls contact our Technical Dept.)</i>
APPLICAZIONI <i>APPLICATIONS</i>		Circuiti pneumatici, oleodinamici e idraulici. <i>Pneumatic, oleodynamic and hydraulic circuits.</i>
TEMPERATURE E PRESSIONI <i>TEMPERATURES AND PRESSURES</i>		Le temperature e le pressioni dipendono generalmente dalle caratteristiche del tubo impiegato. La pressione massima consigliata è 60 bar. <i>Temperatures and pressures usually depend by the technical features of the employed tubes. Max pressure suggested 60 bar.</i>
FILETTATURE <i>THREAD TYPE</i>		BSP cilindrica UNI-ISO 228; BSP conica UNI-ISO 7; Metrica ISO/R 262. <i>BSP parallel UNI-ISO 228; BSP tapered UNI-ISO 7; Metric ISO/R 262</i>
MATERIALI <i>MATERIALS</i>	corpi <i>bodies</i>	Ottone UNI EN 12164 CW614N (barra); UNI EN 12165 CW617N (stampato) <i>Brass UNI EN 12164 CW614N (bar); UNI EN 12165 CW617N (molded)</i>
	guarnizioni tenuta <i>seals</i>	NBR 70 DWGV-EN549 UL157 <i>NBR 70 DWGV-EN549 UL157</i>
	rondelle <i>washers</i>	Nylon/Alluminio <i>Aluminium/Nylon</i>

BREVE DESCRIZIONE

I raccordi ad ogiva della nostra serie **200**, sono realizzati in Italia, a garanzia di elevati standard di qualità, secondo le normative ISO/DIN di riferimento, e rispondono alle seguenti specifiche tecniche e applicative.

SHORT DESCRIPTION

The compressed **200** series fittings are produced in Italy according to the reference ISO/DIN norms as warranty of high quality level and answer to the followings technical specifications and applications.

SCHEMA TECNICA TECHNICAL SHEET

FLUIDI UTILIZZABILI <i>EMPLOYABLE FLUIDS</i>		Aria compressa, acqua fino 100 °C (per altri fluidi contattare il nostro UT) <i>Compressed air, water up to 100 °C</i> <i>(for different fluid pls contact our Technical Dept.)</i>
APPLICAZIONI <i>APPLICATIONS</i>		Circuiti pneumatici, oleodinamici e idraulici. <i>Pneumatic, oleodynamic and hydraulic circuits.</i>
TUBI DI COLLEGAMENTO <i>CONNECTING TUBES</i>	plastici <i>plastic</i>	TPU, PE, PA, PET, PVC intrecciato, PTFE, FEP (solo con l'uso dell'anima di rinforzo interna) <i>TPU, PE, PA, PET, braided PVC, PTFE, FEP</i> <i>(with internal reinforcement included)</i>
	metallici <i>metal</i>	Rame, ottone, acciaio, alluminio, ecc. <i>Copper, brass, steel, aluminium, etc.</i>
FILETTATURE <i>THREAD TYPE</i>		BSP cilindrica UNI-ISO 228; BSPT conica UNI-ISO 7-DIN2999. <i>BSP parallell UNI-ISO 228; BSP tapered UNI-ISO 7-DIN2999.</i>
MATERIALI <i>MATERIALS</i>	corpi <i>bodies</i>	Ottone UNI EN 12164 CW614N (barra); UNI EN 12165 CW617N (stampato) <i>Brass UNI EN 12164 CW614N (bar); UNI EN 12165 CW617N (molded)</i>
	guarnizioni tenuta <i>seals</i>	NBR 70 DWGV-EN549 UL157 <i>NBR 70 DWGV-EN549 UL157</i>
	rondelle <i>washers</i>	Nylon/Alluminio <i>Aluminium/Nylon</i>

BREVE DESCRIZIONE

I raccordi a calzamento della nostra serie **300**, sono realizzati in Italia, a garanzia di elevati standard di qualità, secondo le normative ISO di riferimento, e rispondono alle seguenti specifiche tecniche e applicative.

SHORT DESCRIPTION

The quick **300** series fittings are produced in Italy according to the reference ISO norms as warranty of high quality level and answer to the followings technical specifications and applications.

SCHEMA TECNICA TECHNICAL SHEET

FLUIDI UTILIZZABILI <i>EMPLOYABLE FLUIDS</i>		Aria compressa, acqua fino 100 °C (per altri fluidi contattare il nostro UT) <i>Compressed air, water up to 100 °C (for different fluid pls contact our Technical Dept.)</i>
APPLICAZIONI <i>APPLICATIONS</i>		Circuiti pneumatici, oleodinamici e idraulici. <i>Pneumatic, oleodynamic and hydraulic circuits.</i>
TUBI DI COLLEGAMENTO <i>CONNECTING TUBES</i>	plastici <i>plastic</i>	TPU, PE, PA, PET, PVC intrecciato, PTFE, FEP <i>TPU, PE, PA, PET, braided PVC, PTFE, FEP</i>
	metallici <i>metal</i>	
FILETTATURE <i>THREAD TYPE</i>		BSP cilindrica UNI-ISO 228; BSPT conica UNI-ISO 7-DIN2999; Metrica ISO R/262 <i>BSP parallell UNI-ISO 228; BSP tapered UNI-ISO 7-DIN2999; Metric ISO R/262</i>
MATERIALI <i>MATERIALS</i>	corpi <i>bodies</i>	Ottone UNI EN 12164 CW614N (barra); UNI EN 12165 CW617N (stampato) <i>Brass UNI EN 12164 CW614N (bar); UNI EN 12165 CW617N (molded)</i>
	guarnizioni tenuta <i>seals</i>	NBR 70 DWGV-EN549 UL157 <i>NBR 70 DWGV-EN549 UL157</i>
	rondelle <i>washers</i>	Nylon/Alluminio <i>Aluminium/Nylon</i>

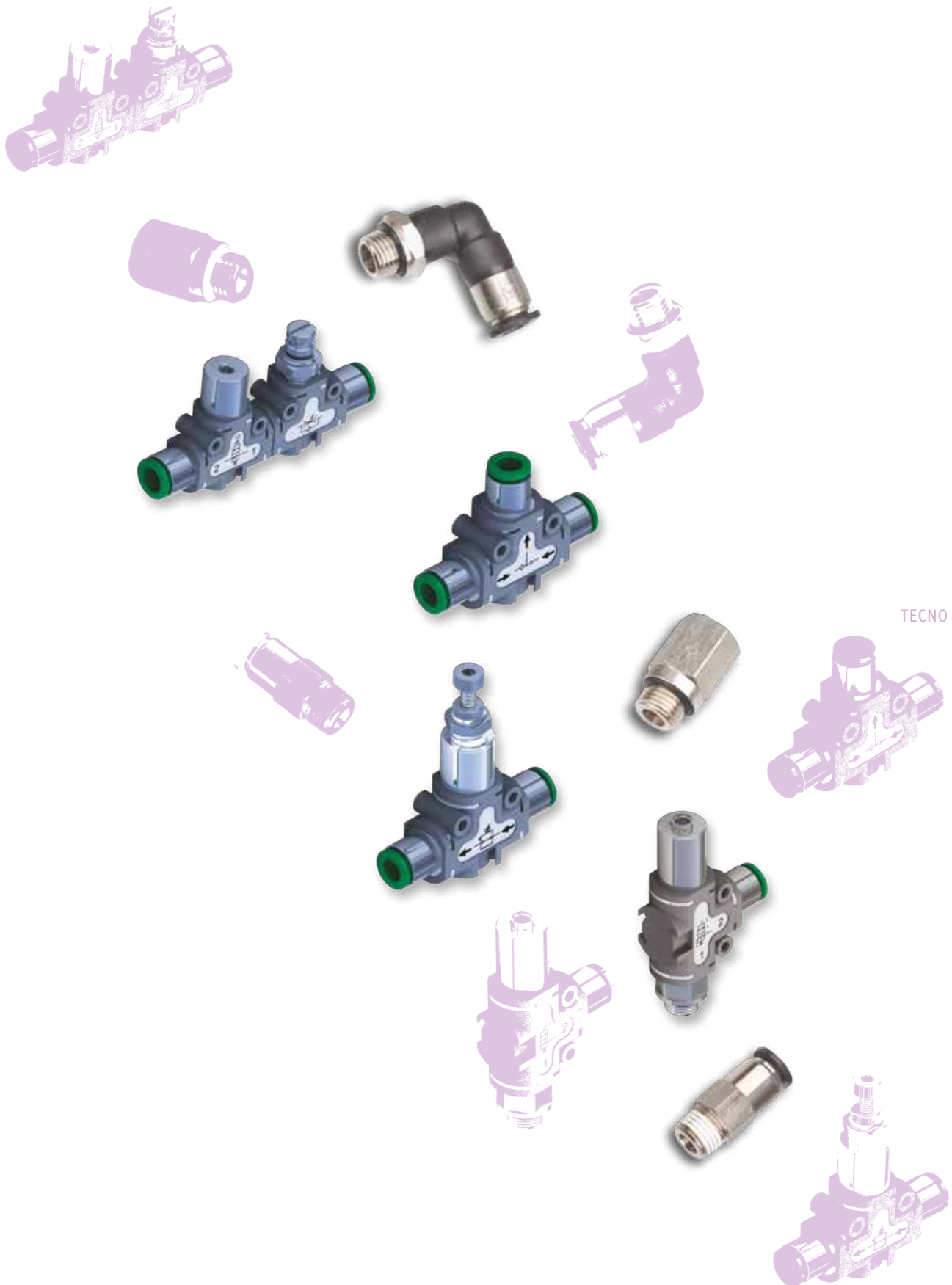

TECNO FUN

ART. 551.11T.A.B.XX

 Regolatore di flusso
Flow regulator

TIPOLOGIA	VERSION
T 1 = Unidirezionale 2 = Bidirezionale	T 1 = Unidirectional 2 = Bidirectional
A Connessione A - Vedi LISTA	A Connection A - see LIST
B Connessione B - Vedi LISTA	B Connection B - see LIST
LISTA Connessioni	Connections LIST
00 = Non prevista	00 = None
D4 = Diritto Ø4	D4 = Straight Ø4
D6 = Diritto Ø6	D6 = Straight Ø6
D8 = Diritto Ø8	D8 = Straight Ø8
L1 = Anello girevole metallo G1/8"	L1 = Female banjo G1/8"/8"
G4 = Anello PL girevole Ø4	G4 = Rotating banjo Ø4
G6 = Anello PL girevole Ø6	G6 = Rotating banjo Ø6
G8 = Anello PL girevole Ø8	G8 = Rotating banjo Ø8
M1 = G1/8 maschio	M1 = G1/8 male
M2 = G1/4 maschio	M2 = G1/4 male
F1 = G1/8 femmina	F1 = G1/8 female

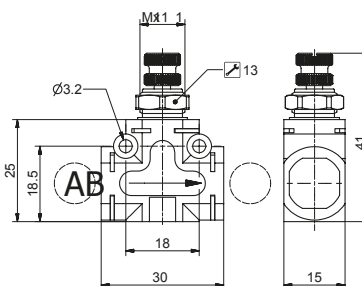

NOTA: Per Ingombro con cartucce vedi pagina Connessioni di alimentazione
Esempio: 551.111.D6.D6.XX
Regolatore di flusso unidirezionale. Connessioni di alimentazione "A" e "B" Tubo Ø6

NOTE: For the dimension including cartridges see page CONNECTIONS
Example: 551.111.D6.D6.XX
Flow control valve, unidirectional, CONNECTIONS "A" and "B" Tube Ø6

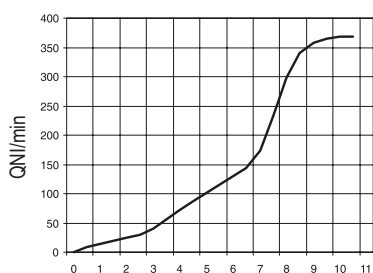
 Curva di portata a 6 bar
Flow-rates curves 6 bar

Giri di regolazione della vite Adjusting screw revolutions

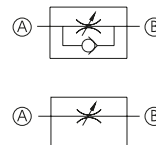
 Simboli pneumatici
Pneumatic Symbol

Caratteristiche costruttive

- Una valvola regolatrice di flusso viene utilizzata per regolare la portata d'aria, in particolare ad es. la velocità dei cilindri. Abbiamo due tipologie di valvole regolatrici, Unidirezionale e Bidirezionale. La valvola tipo unidirezionale di flusso regola in una sola direzione, mentre nella direzione opposta il flusso è libero. La valvola tipo bidirezionale permette la regolazione nei due sensi di flusso.
- Ghiera di fissaggio a pannello.
- Possibile ancoraggio su barra DIN mediante adattatori (vedi accessori).
- Possibile ancoraggio con squadretta a 90° (vedi accessori).
- Possibile fissaggio a parete mediante fori presenti sul corpo.

Construction characteristics

- The flow control valve is normally used to regulate the air flow and, as a consequence, for example, the speed of a cylinder. Two types of flow control valves are available: unidirectional and bidirectional. In the unidirectional valve the flow is regulated only in one direction while is free to move in the opposite direction; in the bidirectional valve the flow is regulated in both directions.
- Mounting options:
- panel mounting using the lock nut supplied as standard
- on DIN rail using the relevant adaptor kit (see accessories)
- with 90° bracket (see accessories)
- directly on the support plate thanks to two through holes on the body

Caratteristiche tecniche

Fluido	Aria filtrata e lubrificata o non
Connessioni di alimentazione	Vedi LISTA Connessioni di alimentazione
Pressione di funzionamento max. (bar)	10
Temperatura di esercizio in °C	-5 ÷ + 50
Peso (gr)	26
Diametro nominale di passaggio (mm)	Ø3
Portata in scarico libero nel senso opposto alla regolazione (Versione Unidirezionale) (Nl/min)	800

Technical characteristics

Fluid	Filtered and lubricated air or not
Connections	See CONNECTIONS LIST
Max working pressure	10 bar
Working temperature	-5°C ÷ +50°C
Weight without connections	26 gr.
Ø Orifice size	Ø3 mm.
Free exhaust flow rate in the opposite side of the regulation (for unidirectional version)	800 Nl/min.

ART. 551.12T.A.B.XX

Riduttore di pressione in linea
In line pressure regulator

TIPOLOGIA	VERSION
T 2 = 0 - 2 bar 4 = 0 - 4 bar 8 = 0 - 8 bar	T 2 = 0 - 2 bar 4 = 0 - 4 bar 8 = 0 - 8 bar
A Connessione A - Vedi LISTA	A Connection A - see LIST
B Connessione B - Vedi LISTA	B Connection B - see LIST
LISTA Connessioni	Connections LIST
00 = Non prevista	00 = None
D4 = Dritto Ø4	D4 = Straight Ø4
D6 = Dritto Ø6	D6 = Straight Ø6
D8 = Dritto Ø8	D8 = Straight Ø8
L1 = Anello girevole metallo G1/8"	L1 = Female banjo G1/8"
G4 = Anello PL girevole Ø4	G4 = Rotating banjo Ø4
G6 = Anello PL girevole Ø6	G6 = Rotating banjo Ø6
G8 = Anello PL girevole Ø8	G8 = Rotating banjo Ø8
M1 = G1/8 maschio	M1 = G1/8 male
M2 = G1/4 maschio	M2 = G1/4 male
F1 = G1/8 femmina	F1 = G1/8 female

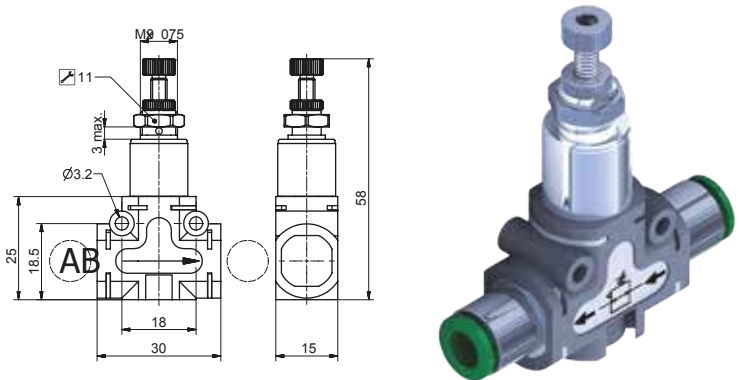

NOTA: Per Ingombro con cartucce vedi pagina Connessioni di alimentazione
Esempio: 551.128.D8.D8.XX
Riduttore di pressione in linea, gamma 0 - 8 bar. Connessioni di alimentazione "A" e "B"
Tubo Ø8

NOTE: For the dimension including cartridges see page CONNECTIONS
Example: 551.128.D8.D8.XX
In line pressure regulator, pressure range 0 - 8 bar. CONNECTIONS "A" and "B"
Tube Ø8

Simboli pneumatici
Pneumatic Symbol

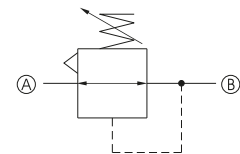

Caratteristiche costruttive

- Il riduttore di pressione (o regolatore) è un dispositivo che consente di ridurre, regolare e stabilizzare la pressione dell'aria a disposizione in rete, adattandola alle esigenze degli apparecchi da alimentare. Riduttore di pressione con scarico della sovrappressione (funzione relieving).
- Ghiera di fissaggio a pannello.
- Possibile ancoraggio su barra DIN mediante adattatori (vedi accessori).
- Possibile ancoraggio con squadretta a 90° (vedi accessori).
- Possibile fissaggio a parete mediante fori presenti sul corpo.

Caratteristiche tecniche

Fluido	Aria filtrata e lubrificata o non
Connessioni di alimentazione	Vedi LISTA Connessioni di alimentazione
Pressione di funzionamento max. (bar)	10
Temperatura di esercizio in °C	-5 ÷ + 50
Peso (gr)	31
Portata a 6 bar con Δp=1 (NI/min)	180
Gamma di regolazione della pressione (bar)	0 ÷ 2 / 0 ÷ 4 / 0 ÷ 8

Construction characteristics

- The pressure regulator is a device which is used to reduce, regulate and stabilize the air pressure in a conduit in order to adapt it to the needs of the equipments to be supplied. The pressure regulator incorporates the relieving function.
- Mounting options:
- panel mounting using the lock nut supplied as standard
- on DIN rail using the relevant adaptor kit (see accessories)
- with 90° bracket (see accessories)
- directly on the support plate thanks to two through holes on the body

Technical characteristics

Fluid	Filtered and lubricated air or not
Connections	See CONNECTIONS LIST
Max inlet pressure	10 bar
Working temperature	-5°C ÷ +50°C
Weight without connections	31 gr.
Flow rate at 6 bar with Δp=1	180 NI/min
Regulated pressure range	0 ÷ 2 / 0 ÷ 4 / 0 ÷ 8

ART. 551.22T.A.B.XX

 Riduttore di pressione a 90°
 90° pressure regulator

TIPOLOGIA	VERSION
T 2 = 0 - 2 bar 4 = 0 - 4 bar 8 = 0 - 8 bar	T 2 = 0 - 2 bar 4 = 0 - 4 bar 8 = 0 - 8 bar
A Connessione A - Vedi LISTA	A Connection A - see LIST
B Connessione B - Vedi LISTA	B Connection B - see LIST
LISTA Connessioni	Connections LIST
00 = Non prevista	00 = None
D4 = Diritto Ø4	D4 = Straight Ø4
D6 = Diritto Ø6	D6 = Straight Ø6
D8 = Diritto Ø8	D8 = Straight Ø8
L1 = Anello girevole metallo G1/8"	L1 = Female banjo G1/8"
G4 = Anello PL girevole Ø4	G4 = Rotating banjo Ø4
G6 = Anello PL girevole Ø6	G6 = Rotating banjo Ø6
G8 = Anello PL girevole Ø8	G8 = Rotating banjo Ø8
M1 = G1/8 maschio	M1 = G1/8 male
M2 = G1/4 maschio	M2 = G1/4 male
F1 = G1/8 femmina	F1 = G1/8 female

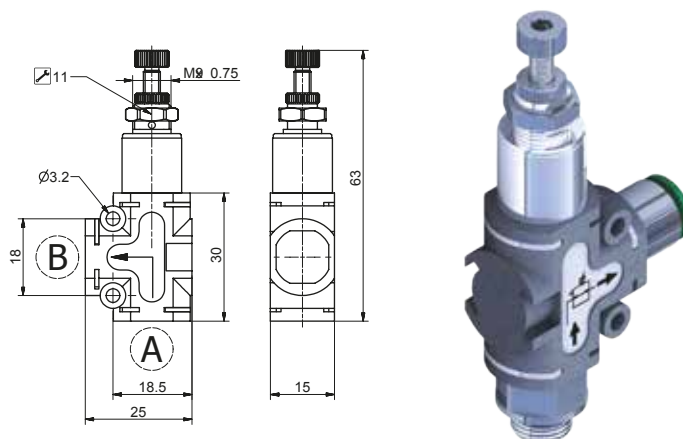

NOTA: Per Ingombro con cartucce vedi pagina Connessioni di alimentazione
 Esempio: 551.224.M1.D6.XX
 Riduttore di pressione a 90°, gamma pressione 0 - 4 bar. Connessioni di alimentazione "A" Maschio G1/8 e "B" Tubo Ø6

NOTE: For the dimension including cartridges see page CONNECTIONS
 Example: 551.224.M1.D6.XX
 90° pressure regulator, pressure range 0 - 4 bar. CONNECTIONS "A" Male G1/8 and "B" Tube Ø6

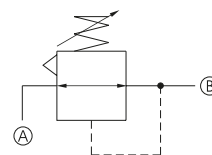
 Simboli pneumatici
 Pneumatic Symbol

Caratteristiche costruttive

- Il riduttore di pressione (o regolatore) è un dispositivo che consente di ridurre, regolare e stabilizzare la pressione dell'aria a disposizione in rete, adattandola alle esigenze degli apparecchi da alimentare. Riduttore di pressione con scarico della sovrappressione (funzione relieving).
- Ghiera di fissaggio a pannello.
- Possibile ancoraggio su barra DIN mediante adattatori (vedi accessori).
- Possibile ancoraggio con squadretta a 90° (vedi accessori).
- Possibile fissaggio a parete mediante fori presenti sul corpo.

Caratteristiche tecniche

Fluido	Aria filtrata e lubrificata o non
Connessioni di alimentazione	Vedi LISTA Connessioni di alimentazione
Pressione di funzionamento max. (bar)	10
Temperatura di esercizio in °C	-5 ÷ + 50
Peso (gr)	31
Portata a 6 bar con Δp=1 (NI/min)	180
Gamma di regolazione della pressione (bar)	0 ÷ 2 / 0 ÷ 4 / 0 ÷ 8

Construction characteristics

- The pressure regulator is a device which is used to reduce, regulate and stabilize the air pressure in a conduit in order to adapt it to the needs of the equipments to be supplied. The pressure regulator incorporates the relieving function.
- Mounting options:
 - panel mounting using the lock nut supplied as standard
 - on DIN rail using the relevant adaptor kit (see accessories)
 - with 90° bracket (see accessories)
 - directly on the support plate thanks to two through holes on the body

Technical characteristics

Fluid	Filtered and lubricated air or not
Connections	See CONNECTIONS LIST
Max inlet pressure	10 bar
Working temperature	-5°C ÷ +50°C
Weight without connections	31 gr.
Flow rate at 6 bar with Δp=1	180 NI/min
Regulated pressure range	0 ÷ 2 / 0 ÷ 4 / 0 ÷ 8

ART. 551.13T.A.B.XX

Valvole di blocco
Blocking valve

TIPOLOGIA	VERSION
T 1 = Unidirezionale 2 = Bidirezionale	T 1 = Unidirectional 2 = Bidirectional
A Connessione A - Vedi LISTA	A Connection A - see LIST
B Connessione B - Vedi LISTA	B Connection B - see LIST
LISTA Connessioni	Connections LIST
00 = Non prevista	00 = None
D4 = Dritto Ø4	D4 = Straight Ø4
D6 = Dritto Ø6	D6 = Straight Ø6
D8 = Dritto Ø8	D8 = Straight Ø8
L1 = Anello girevole metallo G1/8"	L1 = Female banjo G1/8"/8"
G4 = Anello PL girevole Ø4	G4 = Rotating banjo Ø4
G6 = Anello PL girevole Ø6	G6 = Rotating banjo Ø6
G8 = Anello PL girevole Ø8	G8 = Rotating banjo Ø8
M1 = G1/8 maschio	M1 = G1/8 male
M2 = G1/4 maschio	M2 = G1/4 male
F1 = G1/8 femmina	F1 = G1/8 female

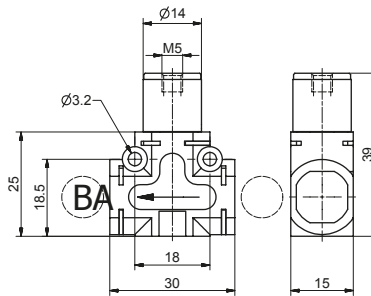

NOTA: Per Ingombro con cartucce vedi pagina Connessioni di alimentazione
Esempio: 551.131.D4.D4.XX
Valvola di blocco in linea unidirezionale. Connessioni di alimentazione "A" e "B" Tubo Ø4
Questi componenti non devono essere intesi né utilizzati come elementi di sicurezza

NOTE : For the dimension including cartridges see page CONNECTIONS
Example: 551.131.D4.D4.XX
In line blocking valve, unidirectional, CONNECTIONS "A" and "B" Tube Ø4
These components must not be understood and used as security elements

Curva di pilotaggio
Piloting curves

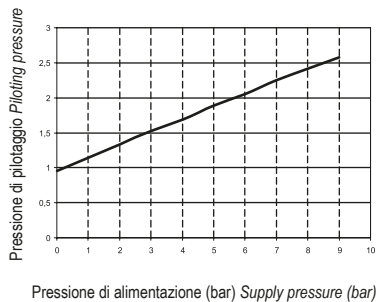

Pressione di alimentazione (bar) Supply pressure (bar)

Simboli pneumatici
Pneumatic Symbol

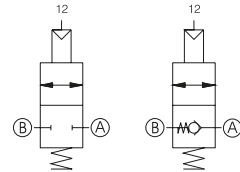

Caratteristiche costruttive

- La funzione della valvola di blocco è quella di mantenere in pressione il circuito a valle nel caso in cui venga a mancare la sorgente di pressione. Viene solitamente impiegata direttamente sulle bocche di alimentazione dei cilindri per poterli mantenere in posizione nel caso in cui si interrompa accidentalmente il segnale di pilotaggio impedendo così un' improvvisa depressurizzazione delle camere in pressione. E' prevista sia la versione unidirezionale che la versione bidirezionale.
- La versione unidirezionale consente il passaggio d' aria in un senso, mentre per il passaggio nel senso opposto è necessario inviare un segnale di pilotaggio alla bocca 12.
- La versione bidirezionale, invece, consente il passaggio d'aria nei due sensi solo in presenza del segnale di pilotaggio.
- Possibile ancoraggio su barra DIN mediante adattatori (vedi accessori).
- Possibile ancoraggio con squadretta a 90° (vedi accessori).
- Possibile fissaggio a parete mediante fori presenti sul corpo.

Caratteristiche tecniche

Fluido	Aria filtrata e lubrificata o non
Connessioni di alimentazione	Vedi LISTA Connessioni di alimentazione
Pressione di funzionamento max. (bar)	0,5 ÷ 10
Temperatura di esercizio in °C	-5 ÷ + 50
Peso (gr)	26
Portata a 6 bar con Δp=1 (Nl/min)	285
Portata a 6 bar scarico libero (nl/min.)	450

Construction characteristics

- The blocking valve function is to maintain the circuit downstream pressure in the event of loss of supply pressure. It is normally fitted directly onto the cylinder connections ports in order to ensure that, in case of accidental loss of the supply pressure, the units positions is maintained. This is achieved as the blocking valve preserves the pressure inside the pressurised chamber. Blocking valves can be unidirectional or bidirectional. In the unidirectional version the air flow is free in one direction while in order to allow the flow in the opposite direction is necessary to send a pneumatic signal to the unit connection 12. The bidirectional version requires a pneumatic signal on connection 12 to allow the flow in any of the two directions.
- Mounting options:
 - on DIN rail using the relevant adaptor kit (see accessories)
 - with 90° bracket (see accessories)
 - directly on the support plate thanks to two through holes on the body

Technical characteristics

Fluid	Filtered and lubricated air or not
Connections	See CONNECTIONS LIST
Max working pressure	10 bar
Working temperature	-5°C ÷ +50°C
Weight without connections	26 gr.
Flow rate at 6 bar with Δp=1 Unidirectional and bidirectional version	285 Nl/min
Flow rate at 6 bar with free exhaust Unidirectional and bidirectional version	450 Nl/min

ART. 551.23T.A.B.XX

 Valvole di blocco a 90°
 90° blocking valve

TIPOLOGIA	VERSION
T 1 = Unidirezionale 2 = Bidirezionale	T 1 = Unidirectional 2 = Bidirectional
A Connessione A - Vedi LISTA	A Connection A - see LIST
B Connessione B - Vedi LISTA	B Connection B - see LIST
LISTA Connessioni	Connections LIST
00 = Non prevista	00 = None
D4 = Diritto Ø4	D4 = Straight Ø4
D6 = Diritto Ø6	D6 = Straight Ø6
D8 = Diritto Ø8	D8 = Straight Ø8
L1 = Anello girevole metallo G1/8"	L1 = Female banjo G1/8"/8"
G4 = Anello PL girevole Ø4	G4 = Rotating banjo Ø4
G6 = Anello PL girevole Ø6	G6 = Rotating banjo Ø6
G8 = Anello PL girevole Ø8	G8 = Rotating banjo Ø8
M1 = G1/8 maschio	M1 = G1/8 male
M2 = G1/4 maschio	M2 = G1/4 male
F1 = G1/8 femmina	F1 = G1/8 female

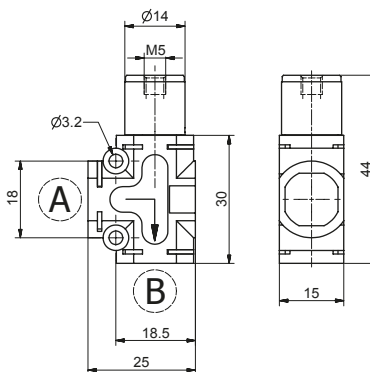

NOTA: Per Ingombro con cartucce vedi pagina Connessioni di alimentazione

Esempio: 551.231.M1.D6.XX

Valvola di blocco a 90°. Connessioni di alimentazione "A" Maschio G1/8 e "B" Tubo Ø6

Questi componenti non devono essere intesi né utilizzati come elementi di sicurezza

NOTE: For the dimension including cartridges see page CONNECTIONS

Example: 551.231.M1.D6.XX

90° blocking valve, unidirectional, CONNECTIONS "A" Male G1/8 and "B" Tube Ø6

These components must not be understood and used as security elements

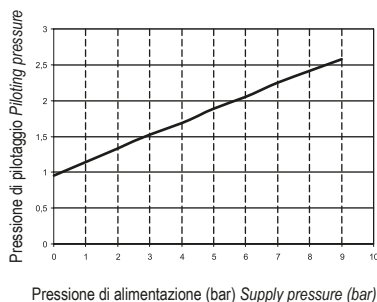
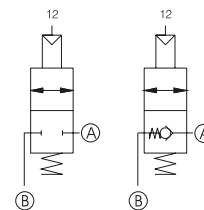
 Curva di pilotaggio
 Piloting curves

 Simboli pneumatici
 Pneumatic Symbol

Caratteristiche costruttive

- La funzione della valvola di blocco è quella di mantenere in pressione il circuito a valle nel caso in cui venga a mancare la sorgente di pressione. Viene solitamente impiegata direttamente sulle bocche di alimentazione dei cilindri per poterli mantenere in posizione nel caso in cui si interrompa accidentalmente il segnale di pilotaggio impedendo così un'improvvisa depressurizzazione delle camere in pressione.
- E' prevista sia la versione unidirezionale che la versione bidirezionale.
- La versione unidirezionale consente il passaggio d'aria in un senso, mentre per il passaggio nel senso opposto è necessario inviare un segnale di pilotaggio alla bocca 12.
- La versione bidirezionale, invece, consente il passaggio d'aria nei due sensi solo in presenza del segnale di pilotaggio.
- Possibile ancoraggio su barra DIN mediante adattatori (vedi accessori).
- Possibile ancoraggio con squadretta a 90° (vedi accessori).
- Possibile fissaggio a parete mediante fori presenti sul corpo.

Caratteristiche tecniche

Fluido	Aria filtrata e lubrificata o non
Connessioni di alimentazione	Vedi LISTA Connessioni di alimentazione
Pressione di funzionamento max. (bar)	0,5 ÷ 10
Temperatura di esercizio in °C	-5 ÷ + 50
Peso (gr)	26
Portata a 6 bar con Δp=1 (Nl/min)	285
Portata a 6 bar scarico libero (nl/min.)	450

Construction characteristics

- The blocking valve function is to maintain the circuit downstream pressure in the event of loss of supply pressure. It is normally fitted directly onto the cylinder connections ports in order to ensure that, in case of accidental loss of the supply pressure, the units positions is maintained. This is achieved as the blocking valve preserves the pressure inside the pressurised chamber. Blocking valves can be unidirectional or bidirectional. In the unidirectional version the air flow is free in one direction while in order to allow the flow in the opposite direction is necessary to send a pneumatic signal to the unit connection 12. The bidirectional version requires a pneumatic signal on connection 12 to allow the flow in any of the two directions.
- Mounting options:
 - on DIN rail using the relevant adaptor kit (see accessories)
 - with 90° bracket (see accessories)
 - directly on the support plate thanks to two through holes on the body

Technical characteristics

Fluid	Filtered and lubricated air or not
Connections	See CONNECTIONS LIST
Max working pressure	10 bar
Working temperature	-5°C ÷ +50°C
Weight without connections	26 gr.
Flow rate at 6 bar with Δp=1 Unidirectional and bidirectional version	285 Nl/min
Flow rate at 6 bar with free exhaust Unidirectional and bidirectional version	450 Nl/min

ART. 551.141A.B.C

Valvola selettoria di circuito OR
Circuit selector valve - OR

TIPOLOGIA	
A	Connessione A - Vedi LISTA
B	Connessione B - Vedi LISTA
C	Connessione C - Vedi LISTA
LISTA Connessioni	
00 = Non prevista	
D4 = Diritto Ø4	
D6 = Diritto Ø6	
D8 = Diritto Ø8	
L1 = Anello girevole metallo G1/8"	
G4 = Anello PL girevole Ø4	
G6 = Anello PL girevole Ø6	
G8 = Anello PL girevole Ø8	
M1 = G1/8 maschio	
M2 = G1/4 maschio	
F1 = G1/8 femmina	

VERSION	
A	Connection A - see LIST
B	Connection B - see LIST
C	Connection C - see LIST
Connections LIST	
00 = None	
D4 = Straight Ø4	
D6 = Straight Ø6	
D8 = Straight Ø8	
L1 = Female banjo G1/8"	
G4 = Rotating banjo Ø4	
G6 = Rotating banjo Ø6	
G8 = Rotating banjo Ø8	
M1 = G1/8 male	
M2 = G1/4 male	
F1 = G1/8 female	

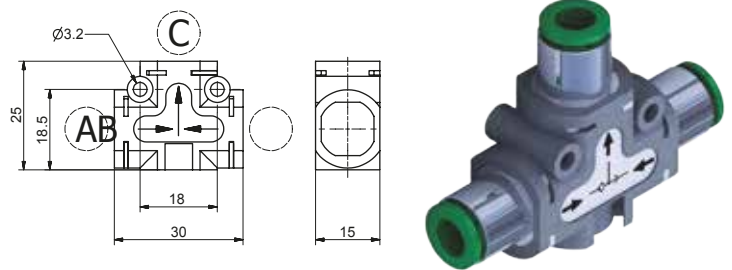

NOTA: Per Ingombro con cartucce vedi pagina Connessioni di alimentazione
Esempio: 551.141.D8.D8.D8
Valvola selettoria di circuito OR. Connessioni di alimentazione "A", "B" e "C" Tubo Ø8

NOTE : For the dimension including cartridges see page CONNECTIONS
Example: 551.141.D8.D8.D8
Circuit selector valve OR, CONNECTIONS "A", "B" and "C" Tube Ø8

Simboli pneumatici
Pneumatic Symbol

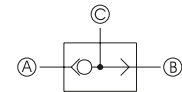

Caratteristiche costruttive

- Sono valvole a 3 vie con due ingressi e un'uscita, in presenza di due segnali pneumatici con valori diversi queste valvole scelgono in uscita il valore più alto, per questo sono anche dette selettori di alta pressione. Sono impiegate per permettere l'azionamento di un componente da due diverse posizioni.
- Possibile ancoraggio su barra DIN mediante adattatori (vedi accessori).
- Possibile ancoraggio con squadretta a 90° (vedi accessori).
- Possibile fissaggio a parete mediante fori presenti sul corpo.

Caratteristiche tecniche

Fluido	Aria filtrata e lubrificata o non
Connessioni di alimentazione	Vedi LISTA Connessioni di alimentazione
Pressione di funzionamento max. (bar)	10
Temperatura di esercizio in °C	-5 ÷ + 50
Peso (gr)	10
Portata a 6 bar con Δp=1 (NI/min)	600

Construction characteristics

- These valves have two inlets and one output connection and are normally called high pressure selector valves as, when receiving two separate pressure supply, only allow the passage of the highest pressure. The most common application is to operate a component from two separate positions.
- Mounting options:
- on DIN rail using the relevant adaptor kit (see accessories)
- with 90° bracket (see accessories)
- directly on the support plate thanks to two through holes on the body

Technical characteristics

Fluid	Filtered and lubricated air or not
Connections	See CONNECTIONS LIST
Max inlet pressure	10 bar
Working temperature	-5°C ÷ +50°C
Weight without connections	10 gr.
Flow rate at 6 bar with Δp=1	600 NI/min

ART. 551.151A.B.C

 Valvola selettoria di circuito AND
Circuit selector valve - AND

TIPOLOGIA	VERSION
A Connessione A - Vedi LISTA	A Connection A - see LIST
B Connessione B - Vedi LISTA	B Connection B - see LIST
C Connessione C - Vedi LISTA	C Connection C - see LIST
LISTA Connessioni	Connections LIST
00 = Non prevista	00 = None
D4 = Diritto Ø4	D4 = Straight Ø4
D6 = Diritto Ø6	D6 = Straight Ø6
D8 = Diritto Ø8	D8 = Straight Ø8
L1 = Anello girevole metallo G1/8"	L1 = Female banjo G1/8"
G4 = Anello PL girevole Ø4	G4 = Rotating banjo Ø4
G6 = Anello PL girevole Ø6	G6 = Rotating banjo Ø6
G8 = Anello PL girevole Ø8	G8 = Rotating banjo Ø8
M1 = G1/8 maschio	M1 = G1/8 male
M2 = G1/4 maschio	M2 = G1/4 male
F1 = G1/8 femmina	F1 = G1/8 female

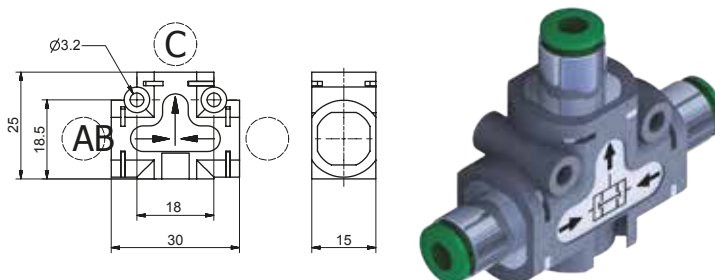

NOTA: Per Ingombro con cartucce vedi pagina Connessioni di alimentazione
 Esempio: 551.151.D6.D6.D6
 Valvola selettoria di circuito AND. Connessioni di alimentazione "A", "B" e "C" Tubo Ø6

NOTE: For the dimension including cartridges see page CONNECTIONS
 Example: 551.151.D6.D6.D6
 Circuit selector valve AND, CONNECTIONS "A", "B" and "C" Tube Ø6

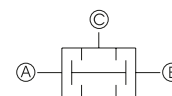
 Simboli pneumatici
 Pneumatic Symbol

Caratteristiche costruttive

- Sono valvole a 3 vie con due ingressi e un'uscita, in presenza di due segnali pneumatici con valori diversi queste valvole scelgono in uscita il valore più basso, per questo sono anche dette selettori di bassa pressione. Sono impiegate per permettere l'azionamento di un componente da due diverse posizioni.
- Possibile ancoraggio su barra DIN mediante adattatori (vedi accessori).
- Possibile ancoraggio con squadretta a 90° (vedi accessori).
- Possibile fissaggio a parete mediante fori presenti sul corpo.

Caratteristiche tecniche

Fluidi	Aria filtrata e lubrificata o non
Connessioni di alimentazione	Vedi LISTA Connessioni di alimentazione
Pressione di funzionamento max. (bar)	10
Temperatura di esercizio in °C	-5 ÷ + 50
Peso (gr)	10
Portata a 6 bar con Δp=1 (NI/min)	550

Construction characteristics

- These valves have two inlets and one output connection and are normally called low pressure selector valves as, when receiving two separate pressure supply, only allow the passage of the lowest pressure. The most common application is to operate a component from two separate positions.
- Mounting options:
- on DIN rail using the relevant adaptor kit (see accessories)
- with 90° bracket (see accessories)
- directly on the support plate thanks to two through holes on the body

Technical characteristics

Fluid	Filtered and lubricated air or not
Connections	See CONNECTIONS LIST
Max inlet pressure	10 bar
Working temperature	-5°C ÷ +50°C
Weight without connections	10 gr.
Flow rate at 6 bar with Δp=1	550 NI/min

ART. 551.161A.B.XX

Valvola di scarico rapido
Quick exhaust valve

TIPOLOGIA	VERSION
A Connessione A - Vedi LISTA	A Connection A - see LIST
B Connessione B - Vedi LISTA	B Connection B - see LIST
LISTA Connessioni	Connections LIST
00 = Non prevista	00 = None
D4 = Dritto Ø4	D4 = Straight Ø4
D6 = Dritto Ø6	D6 = Straight Ø6
D8 = Dritto Ø8	D8 = Straight Ø8
L1 = Anello girevole metallo G1/8"	L1 = Female banjo G1/8"
G4 = Anello PL girevole Ø4	G4 = Rotating banjo Ø4
G6 = Anello PL girevole Ø6	G6 = Rotating banjo Ø6
G8 = Anello PL girevole Ø8	G8 = Rotating banjo Ø8
M1 = G1/8 maschio	M1 = G1/8 male
M2 = G1/4 maschio	M2 = G1/4 male
F1 = G1/8 femmina	F1 = G1/8 female

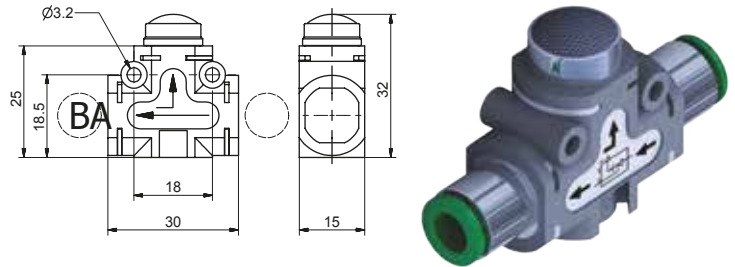

NOTA: Per Ingombro con cartucce vedi pagina Connessioni di alimentazione
Esempio: 551.161.D8.D8.XX
Valvola di scarico rapido. Connessioni di alimentazione "A" e "B" Tubo Ø8

NOTE: For the dimension including cartridges see page CONNECTIONS
Example: 551.161.D8.D8.XX
Quick exhaust valve, CONNECTIONS "A" and "B" Tube Ø8

Simboli pneumatici
Pneumatic Symbol

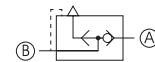

Caratteristiche costruttive

- Sono valvole a 3 vie 2 posizioni. Questo tipo di accessorio montato direttamente sull'attuatore o interposto nel circuito pneumatico tra attuatore e valvola, consente di ottenere ad es. la massima velocità di un cilindro scaricando direttamente l'aria in atmosfera senza il bisogno di attraversare la circuitazione.
- Possibile ancoraggio su barra DIN mediante adattatori (vedi accessori).
- Possibile ancoraggio con squadretta a 90° (vedi accessori).
- Possibile fissaggio a parete mediante fori presenti sul corpo.

Caratteristiche tecniche

Fluido	Aria filtrata e lubrificata o non
Connessioni di alimentazione	Vedi LISTA Connessioni di alimentazione
Pressione di funzionamento max. (bar)	10
Temperatura di esercizio in °C	-5 ÷ + 50
Peso (gr)	15
Portata a 6 bar con Δp=1 (NI/min)	250
Portata max a 6 bar in scarico libero (NI/min)	500

Construction characteristics

- These are 3 ways, two positions valves which can be directly mounted onto the actuator or between the actuator and the control valve. Their function is to discharge the air directly into the atmosphere without going through the pneumatic circuit enabling the actuator to reach the maximum speed.
- Mounting options:
- on DIN rail using the relevant adaptor kit (see accessories)
- with 90° bracket (see accessories)
- directly on the support plate thanks to two through holes on the body

Technical characteristics

Fluid	Filtered and lubricated air or not
Connections	See CONNECTIONS LIST
Max inlet pressure	10 bar
Working temperature	-5°C ÷ +50°C
Weight without connections	15 gr.
Flow rate at 6 bar with Δp=1 (from 1 to 2)	250 NI/min
Flow rate at 6 bar with free exhaust (from 2 to 3)	500 NI/min

ART. 551.178A.B.XX
Indicatore di pressione
Pressure indicator

TIPOLOGIA	VERSION
A Connessione A - Vedi LISTA	A Connection A - see LIST
B Connessione B - Vedi LISTA	B Connection B - see LIST
LISTA Connessioni	Connections LIST
00 = Non prevista	00 = None
D4 = Diritto Ø4	D4 = Straight Ø4
D6 = Diritto Ø6	D6 = Straight Ø6
D8 = Diritto Ø8	D8 = Straight Ø8
L1 = Anello girevole metallo G1/8"	L1 = Female banjo G1/8"
G4 = Anello PL girevole Ø4	G4 = Rotating banjo Ø4
G6 = Anello PL girevole Ø6	G6 = Rotating banjo Ø6
G8 = Anello PL girevole Ø8	G8 = Rotating banjo Ø8
M1 = G1/8 maschio	M1 = G1/8 male
M2 = G1/4 maschio	M2 = G1/4 male
F1 = G1/8 femmina	F1 = G1/8 female

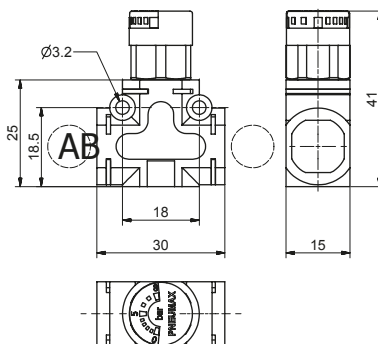

NOTA: Per Ingombro con cartucce vedi pagina Connessioni di alimentazione
 Esempio: 551.178.D6.D4.XX
 Indicatore di pressione, Connessione "A" Tubo Ø6, "B" Tubo Ø4

NOTE: For the dimension including cartridges see page CONNECTIONS
 Example: 551.178.D6.D4.XX
 Pressure indicator, CONNECTIONS "A" Tube Ø6, "B" Tube Ø4

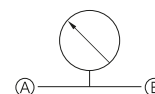
 Simboli pneumatici
Pneumatic Symbol

Caratteristiche costruttive

- L'indicatore di pressione è un dispositivo in grado di misurare la pressione all'interno di un circuito pneumatico. L'inserimento di questo componente permette sempre il monitoraggio della pressione con grande facilità, grazie ad un visualizzatore con fondo scala da 0 a 8 bar.
- Viene impiegato singolarmente, oppure può essere accoppiato con un altro dispositivo.
- Possibile ancoraggio su barra DIN mediante adattatori (vedi accessori).
- Possibile ancoraggio con squadretta a 90° (vedi accessori).
- Possibile fissaggio a parete mediante fori presenti sul corpo.

Caratteristiche tecniche

Fluido	Aria filtrata e lubrificata o non
Connessioni di alimentazione	Vedi LISTA Connessioni di alimentazione
Pressione di funzionamento max. (bar)	8
Temperatura di esercizio in °C	-5 ÷ + 50
Peso (gr)	20,5
Scala di visualizzazione (bar)	0 - 8

Construction characteristics

- The pressure visual indicator is a device which measures the pressure inside a pneumatic circuit. The 0 to 8 bar visual indicator makes very easy to monitor the pressure state inside the circuit. It can be use on its own or can be coupled with another device.
- Mounting options:
- on DIN rail using the relevant adaptor kit (see accessories)
- with 90° bracket (see accessories)
- directly on the support plate thanks to two through holes on the body

Technical characteristics

Fluid	Filtered and lubricated air or not
Connections	See CONNECTIONS LIST
Max. working pressure	8 bar
Working temperature	-5°C ÷ +50°C
Weight without connections	20,5 gr.
Visualization scale	0 - 8 bar

ART. 551.181A.B.XX

Avviatore progressivo in linea
In line progressive star-up valve

TIPOLOGIA	VERSION
A Connessione A - Vedi LISTA	A Connection A - see LIST
B Connessione B - Vedi LISTA	B Connection B - see LIST
LISTA Connessioni	Connections LIST
00 = Non prevista	00 = None
D4 = Diritto Ø4	D4 = Straight Ø4
D6 = Diritto Ø6	D6 = Straight Ø6
D8 = Diritto Ø8	D8 = Straight Ø8
L1 = Anello girevole metallo G1/8"	L1 = Female banjo G1/8"
G4 = Anello PL girevole Ø4	G4 = Rotating banjo Ø4
G6 = Anello PL girevole Ø6	G6 = Rotating banjo Ø6
G8 = Anello PL girevole Ø8	G8 = Rotating banjo Ø8
M1 = G1/8 maschio	M1 = G1/8 male
M2 = G1/4 maschio	M2 = G1/4 male
F1 = G1/8 femmina	F1 = G1/8 female

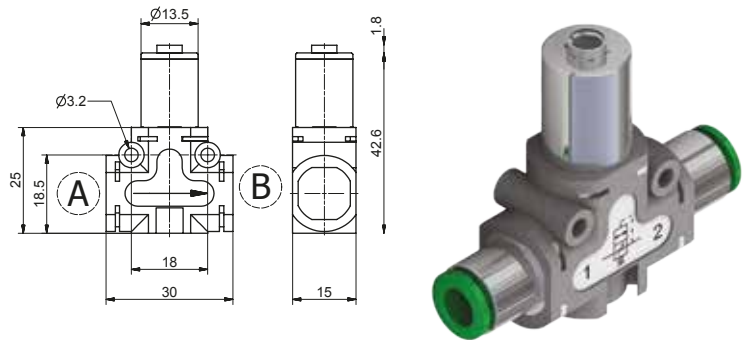

NOTA: Per Ingombro con cartucce vedi pagina Connessioni di alimentazione
Esempio: 551.181.D6.D4.XX
Avviatore progressivo in linea, Connessione "A" Tubo Ø6, "B" Tubo Ø4

NOTE: For the dimension including cartridges see page CONNECTIONS
Example: 551.181.D6.D4.XX
Progressive start-up, CONNECTIONS "A" Tube Ø6, "B" Tube Ø4

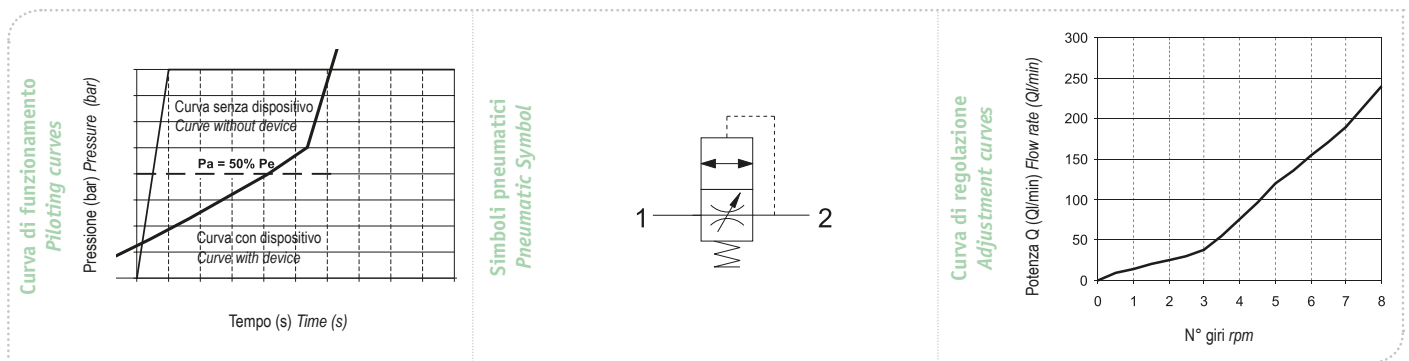

Caratteristiche costruttive

- L'avviatore progressivo è un dispositivo che permette di pressurizzare gradualmente il circuito a valle fino al raggiungimento del 50% del valore di pressione di alimentazione.
- Successivamente nel dispositivo avviene una commutazione che porta ad avere il passaggio d'aria massimo consentito.
- Il tempo di riempimento graduale può essere variato grazie al regolatore di flusso incorporato.
- Solitamente questo componente viene impiegato per fare in modo che, all'avvio dell'impianto pneumatico, i cilindri presenti sul circuito, vengano riportati nella loro posizione d'origine con velocità lenta evitando urti violenti indesiderati.

Construction characteristics

- The soft start valve is a device designed to gradually pressurise the downstream circuit until 50% of the upstream pressure value is reached.
- Once the 50% of the upstream pressure value is reached in the down stream circuit the valve fully opens allowing full air passage.
- The filling time can be adjusted thanks to the built in flow regulator.
- This device is used in order to ensure that during the pneumatic circuit start up the cylinders will return to theirs home position slowly avoiding collisions or sudden movements.

Caratteristiche tecniche

Fluido	Aria filtrata e lubrificata o non
Connessioni di alimentazione	Vedi LISTA Connessioni di alimentazione
Pressione di funzionamento (bar)	2 ÷ 10
Pressione d'apertura (Pa)	50% della pressione di esercizio (Pe)
Portata a 6 bar scarico libero (NI/min.) da 1 a 2 con circuito aperto	650
Portata a 6 bar con Δp=1 (NI/min) da 1 a 2 con circuito aperto	350
Portata a 6 bar con Δp=1 (NI/min) da 2 a 1 con spillo aperto	600
Temperatura di esercizio in °C	-5 ÷ + 50
Peso (gr)	31

Technical characteristics

Fluid	Filtered and lubricated air or not
Connections	See CONNECTIONS LIST
Max. working pressure	2 ÷ 10 bar
Opening pressure (Pa)	50% of the inlet pressure (Pi)
Flow rate at 6 bar with free exhaust	650 NI/min (from 1 to 2 with opening circuit)
Flow rate at 6 bar with Δp=1	350 NI/min (from 1 to 2 with opening circuit)
Flow rate at 6 bar with Δp=1	600 NI/min (from 2 to 1 with opening pin)
Working temperature	-5°C ÷ +50°C
Weight without connections	31 gr.

ART. 551.281A.B.XX

 Avviatore progressivo a 90°
 90° progressive star-up valve

TIPOLOGIA	VERSION
A Connessione A - Vedi LISTA	A Connection A - see LIST
B Connessione B - Vedi LISTA	B Connection B - see LIST
LISTA Connessioni	Connections LIST
00 = Non prevista	00 = None
D4 = Diritto Ø4	D4 = Straight Ø4
D6 = Diritto Ø6	D6 = Straight Ø6
D8 = Diritto Ø8	D8 = Straight Ø8
L1 = Anello girevole metallo G1/8"	L1 = Female banjo G1/8"
G4 = Anello PL girevole Ø4	G4 = Rotating banjo Ø4
G6 = Anello PL girevole Ø6	G6 = Rotating banjo Ø6
G8 = Anello PL girevole Ø8	G8 = Rotating banjo Ø8
M1 = G1/8 maschio	M1 = G1/8 male
M2 = G1/4 maschio	M2 = G1/4 male
F1 = G1/8 femmina	F1 = G1/8 female

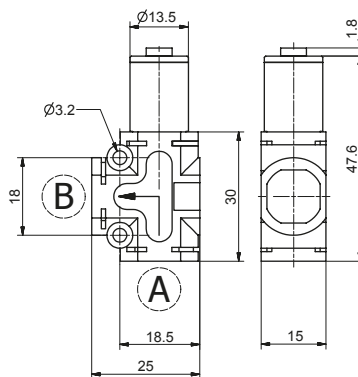

NOTA: Per Ingombro con cartucce vedi pagina Connessioni di alimentazione
 Esempio: 551.281.M1.D4.XX
 Avviatore progressivo a 90°, Connessione "A" Maschio G1/8", "B" Tubo Ø4

NOTE: For the dimension including cartridges see page CONNECTIONS
 Example: 551.281.D6.D4.XX
 Progressive start-up, CONNECTIONS "A" Tube Ø6, "B" Tube Ø4

Curva di funzionamento
Piloting curves

Pressione (bar) Pressure (bar)

Tempo (s) Time (s)

Simboli pneumatici
Pneumatic Symbol

Curva di regolazione
Adjustment curves

Potenza Q (Ql/min) Flow rate (Ql/min)

N° giri rpm

Caratteristiche costruttive

- L'avviatore progressivo è un dispositivo che permette di pressurizzare gradualmente il circuito a valle fino al raggiungimento del 50% del valore di pressione di alimentazione.
- Successivamente nel dispositivo avviene una commutazione che porta ad avere il passaggio d'aria massimo consentito.
- Il tempo di riempimento graduale può essere variato grazie al regolatore di flusso incorporato.
- Solitamente questo componente viene impiegato per fare in modo che, all'avvio dell'impianto pneumatico, i cilindri presenti sul circuito, vengano riportati nella loro posizione d'origine con velocità lenta evitando urti violenti indesiderati.

Construction characteristics

- The soft start valve is a device designed to gradually pressurise the downstream circuit until 50% of the upstream pressure value is reached.
- Once the 50% of the upstream pressure value is reached in the downstream circuit the valve fully opens allowing full air passage.
- The filling time can be adjusted thanks to the built in flow regulator.
- This device is used in order to ensure that during the pneumatic circuit start up the cylinders will return to their home position slowly avoiding collisions or sudden movements.

Caratteristiche tecniche

Fluido	Aria filtrata e lubrificata o non
Connessioni di alimentazione	Vedi LISTA Connessioni di alimentazione
Pressione di funzionamento (bar)	2 + 10
Pressione d'apertura (Pa)	50% della pressione di esercizio (Pe)
Portata a 6 bar scarico libero (NI/min.) da 1 a 2 con circuito aperto	650
Portata a 6 bar con Δp=1 (NI/min) da 1 a 2 con circuito aperto	350
Portata a 6 bar con Δp=1 (NI/min) da 2 a 1 con spillo aperto	600
Temperatura di esercizio in °C	-5 + + 50
Peso (gr)	31

Technical characteristics

Fluid	Filtered and lubricated air or not
Connections	See CONNECTIONS LIST
Max. working pressure	2 + 10 bar
Opening pressure (Pa)	50% of the inlet pressure (Pi)
Flow rate at 6 bar with free exhaust	650 NI/min (from 1 to 2 with opening circuit)
Flow rate at 6 bar with Δp=1	350 NI/min (from 1 to 2 with opening circuit)
Flow rate at 6 bar with Δp=1	600 NI/min (from 2 to 1 with opening pin)
Working temperature	-5°C + +50°C
Weight without connections	31 gr.

ART. 551.1FT.A.B.XX

Valvole di blocco in linea + MRF
In line blocking valve + MRF

TIPOLOGIA	VERSION
T 1 = Valvola di Blocco Unidirezionale + RFU Unidirezionale 2 = Valvola di Blocco Bidirezionale + RFU Bidirezionale 3 = Valvola di Blocco Unidirezionale + RFU Bidirezionale 4 = Valvola di Blocco Bidirezionale + RFU Unidirezionale	T 1 = Unidirectional blocking valve + Unidirectional flow control valve 2 = Bidirectional blocking valve + Bidirectional flow control valve 3 = Unidirectional blocking valve + Bidirectional flow control valve 4 = Bidirectional blocking valve + Unidirectional flow control valve
A Connessione A - Vedi LISTA	A Connection A - see LIST
B Connessione B - Vedi LISTA	B Connection B - see LIST
LISTA Connessioni	Connections LIST
00 = Non prevista	00 = None
D4 = Diritto Ø4	D4 = Straight Ø4
D6 = Diritto Ø6	D6 = Straight Ø6
D8 = Diritto Ø8	D8 = Straight Ø8
L1 = Anello girevole metallo G1/8"	L1 = Female banjo G1/8"/8"
G4 = Anello PL girevole Ø4	G4 = Rotating banjo Ø4
G6 = Anello PL girevole Ø6	G6 = Rotating banjo Ø6
G8 = Anello PL girevole Ø8	G8 = Rotating banjo Ø8
M1 = G1/8 maschio	M1 = G1/8 male
M2 = G1/4 maschio	M2 = G1/4 male
F1 = G1/8 femmina	F1 = G1/8 female

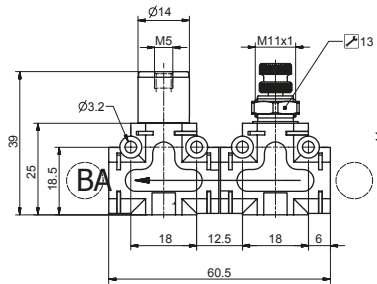

NOTA: Per Ingombro con cartucce vedi pagina Connessioni di alimentazione
Esempio: 551.1F1.00.00.XX

Valvola di blocco in linea + Regolatore di flusso. Connessioni di alimentazione "A" e "B" non previste.

NOTE: For the dimension including cartridges see page CONNECTIONS

Example: 551.1F1.00.00.XX

In line unidirectional blocking valve + unidirectional flow control valve, without CONNECTIONS "A" and "B"

Curva di pilotaggio
Piloting curves

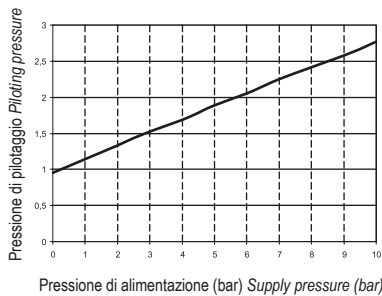

Simboli pneumatici
Pneumatic Symbol

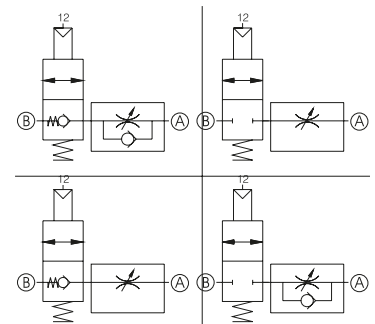

Caratteristiche costruttive

- L'utilizzo di queste 2 funzioni combinate consente di mantenere la pressione nel circuito a valle nel caso in cui venga a mancare la sorgente di pressione, abbinata alla possibilità di regolare la portata d'aria nel circuito. L'applicazione tipica per questo prodotto è direttamente installato in prossimità o direttamente sulla bocca di un cilindro avendo quindi la possibilità di mantenere la camera in pressione nel caso venga a mancare il segnale di pilotaggio con in più la possibilità di regolare la portata in scarico della camera stessa nel momento in cui si pilota la valvola di blocco.
- Le possibili combinazioni sono:
 - Valvola di blocco unidirezionale + regolatore di flusso unidirezionale
 - Valvola di blocco bidirezionale + regolatore di flusso bidirezionale
 - Valvola di blocco bidirezionale + regolatore di flusso unidirezionale
 - Valvola di blocco unidirezionale + regolatore di flusso bidirezionale

Caratteristiche tecniche

Fluido	Aria filtrata e lubrificata o non
Connessioni di alimentazione	Vedi LISTA Connessioni di alimentazione
Pressione di funzionamento max. (bar)	0,5 ÷ 10
Temperatura di esercizio in °C	-5 ÷ + 50
Diametro nominale di passaggio (mm)	Ø3
Portata a 6 bar con Δp=1 (NL/min)	285
Peso (gr.)	62

Construction characteristics

- The combination of this two functions ensures that the downstream pressure is maintained in case of accidental loss of supply pressure and at the same time grants the possibility to regulate the circuit flow rate. A typical application of this combination is close to or directly assembled onto the actuator connection ports. This allows to keep pressurised the cylinder chamber in case of accidental loss of supply pressure and to regulate the exhaust flow rate when the blocking valve is actuated.
- The possible combinations are the following:
 - unidirectional blocking valve + unidirectional flow control valve
 - bidirectional blocking valve + bidirectional flow control valve
 - bidirectional blocking valve + unidirectional flow control valve
 - unidirectional blocking valve + bidirectional flow control valve

Technical characteristics

Fluid	Filtered and lubricated air or not
Connections	See CONNECTIONS LIST
Max working pressure	0,5 ÷ 10 bar
Working temperature	-5°C ÷ +50°C
Ø Orifice size	Ø3 mm
Flow rate at 6 bar with Δp=1	285 NL/min
Weight without connections	62 gr.

ART. 551.2FT.A.B.XX

 Valvole di blocco a 90° + MRF
 90° blocking valve + MRF

TIPOLOGIA	VERSION
T 1 = Valvola di Blocco 90° Unidirezionale + RFU Unidirezionale 2 = Valvola di Blocco 90° Bidirezionale + RFU Bidirezionale 3 = Valvola di Blocco 90° Unidirezionale + RFU Bidirezionale 4 = Valvola di Blocco 90° Bidirezionale + RFU Unidirezionale	T 1 = 90° Unidirectional blocking valve + Unidirectional flow control valve 2 = 90° Bidirectional blocking valve + Bidirectional flow control valve 3 = 90° Unidirectional blocking valve + Bidirectional flow control valve 4 = 90° Bidirectional blocking valve + Unidirectional flow control valve
A Connessione A - Vedi LISTA	A Connection A - see LIST
B Connessione B - Vedi LISTA	B Connection B - see LIST
LISTA Connessioni	Connections LIST
00 = Non prevista	00 = None
D4 = Diritto Ø4	D4 = Straight Ø4
D6 = Diritto Ø6	D6 = Straight Ø6
D8 = Diritto Ø8	D8 = Straight Ø8
L1 = Anello girevole metallo G1/8"	L1 = Female banjo G1/8"
G4 = Anello PL girevole Ø4	G4 = Rotating banjo Ø4
G6 = Anello PL girevole Ø6	G6 = Rotating banjo Ø6
G8 = Anello PL girevole Ø8	G8 = Rotating banjo Ø8
M1 = G1/8 maschio	M1 = G1/8 male
M2 = G1/4 maschio	M2 = G1/4 male
F1 = G1/8 femmina	F1 = G1/8 female

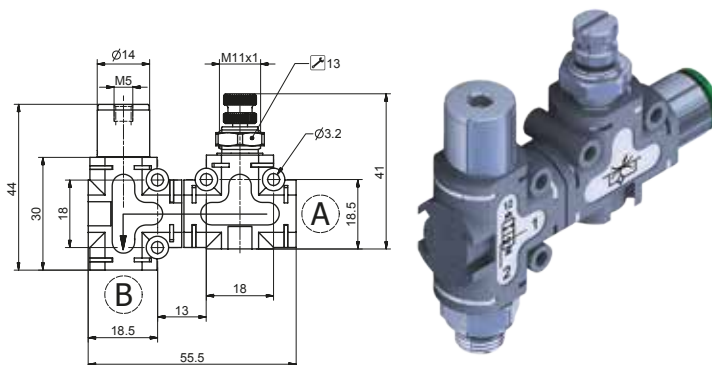

 NOTA: Per Ingombro con cartucce vedi pagina Connessioni di alimentazione
 Esempio: 5512F1.00.00.XX

Valvola di blocco a 90° + Regolatore di flusso. Connessioni di alimentazione "A" e "B" non previste.

NOTE: For the dimension including cartridges see page CONNECTIONS

Example: 551.2F1.00.00.XX

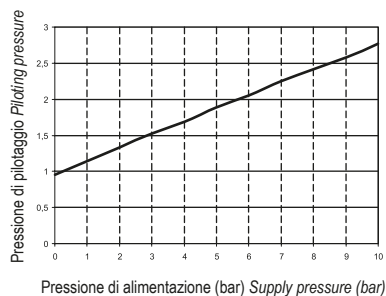
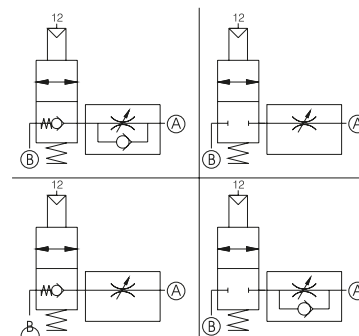
90° unidirectional blocking valve + unidirectional flow control valve, without CONNECTIONS "A" and "B"

 Curva di pilotaggio
 Piloting curves

 Simboli pneumatici
 Pneumatic Symbol

Caratteristiche costruttive

- L'utilizzo di queste 2 funzioni combinate consente di mantenere la pressione nel circuito a valle nel caso in cui venga a mancare la sorgente di pressione, abbinata alla possibilità di regolare la portata d'aria nel circuito. L'applicazione tipica per questo prodotto è direttamente installato in prossimità o direttamente sulla bocca di un cilindro avendo quindi la possibilità di mantenere la camera in pressione nel caso venga a mancare il segnale di pilotaggio con in più la possibilità di regolare la portata in scarico della camera stessa nel momento in cui si pilota la valvola di blocco.
- Le possibili combinazioni sono:
 - Valvola di blocco unidirezionale + regolatore di flusso unidirezionale
 - Valvola di blocco bidirezionale + regolatore di flusso bidirezionale
 - Valvola di blocco bidirezionale + regolatore di flusso unidirezionale
 - Valvola di blocco unidirezionale + regolatore di flusso bidirezionale

Caratteristiche tecniche

Fluido	Aria filtrata e lubrificata o non
Connessioni di alimentazione	Vedi LISTA Connessioni di alimentazione
Pressione di funzionamento max. (bar)	0,5 ÷ 10
Temperatura di esercizio in °C	-5 ÷ + 50
Diametro nominale di passaggio (mm)	Ø3
Portata a 6 bar con Δp=1 (Nl/min)	285
Peso (gr.)	62

Construction characteristics

- The combination of this two functions ensures that the downstream pressure is maintained in case of accidental loss of supply pressure and at the same time grants the possibility to regulate the circuit flow rate. A typical application of this combination is close to or directly assembled onto the actuator connection ports. This allows to keep pressurised the cylinder chamber in case of accidental loss of supply pressure and to regulate the exhaust flow rate when the blocking valve is actuated.
- The possible combinations are the following:
 - unidirectional blocking valve + unidirectional flow control valve
 - bidirectional blocking valve + bidirectional flow control valve
 - bidirectional blocking valve + unidirectional flow control valve
 - unidirectional blocking valve + bidirectional flow control valve

Technical characteristics

Fluid	Filtered and lubricated air or not
Connections	See CONNECTIONS LIST
Max working pressure	0,5 ÷ 10 bar
Working temperature	-5°C ÷ +50°C
Ø Orifice size	Ø3 mm
Flow rate at 6 bar with Δp=1	285 Nl/min
Weight without connections	62 gr.

ART. 551.1GT.A.B.XX

Valvole di blocco in linea + VSR
In line blocking valve + QEV

TIPOLOGIA	VERSION
T 1 = Valvola di Blocco Unidirezionale + scarico rapido 2 = Valvola di Blocco Bidirezionale + scarico rapido	T 1 = Unidirectional blocking valve + quick exhaust valve 2 = Bidirectional blocking valve + quick exhaust valve
A Connessione A - Vedi LISTA	A Connection A - see LIST
B Connessione B - Vedi LISTA	B Connection B - see LIST
LISTA Connessioni	Connections LIST
00 = Non prevista	00 = None
D4 = Diritto Ø4	D4 = Straight Ø4
D6 = Diritto Ø6	D6 = Straight Ø6
D8 = Diritto Ø8	D8 = Straight Ø8
L1 = Anello girevole metallo G1/8"	L1 = Female banjo G1/8"
G4 = Anello PL girevole Ø4	G4 = Rotating banjo Ø4
G6 = Anello PL girevole Ø6	G6 = Rotating banjo Ø6
G8 = Anello PL girevole Ø8	G8 = Rotating banjo Ø8
M1 = G1/8 maschio	M1 = G1/8 male
M2 = G1/4 maschio	M2 = G1/4 male
F1 = G1/8 femmina	F1 = G1/8 female

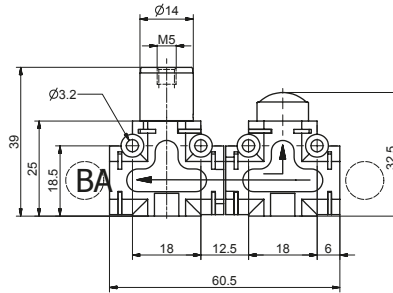

NOTA: Per Ingombro con cartucce vedi pagina Connessioni di alimentazione
Esempio: 5511G1.00.00.XX
Valvola di blocco in linea + Scarico rapido. Connessioni di alimentazione "A" e "B" non previste.

NOTE: For the dimension including cartridges see page CONNECTIONS
Example: 551.1G1.00.00.XX
In line unidirectional blocking valve + quick exhaust valve, without CONNECTIONS "A" and "B"

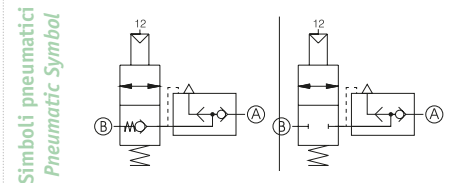
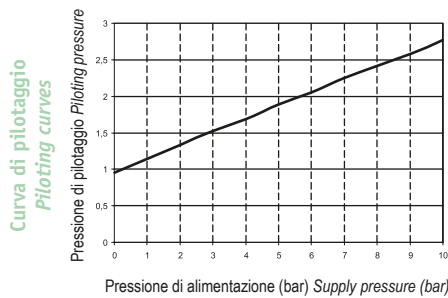

Caratteristiche costruttive

- L'utilizzo di queste 2 funzioni combinate consente di mantenere la pressione nel circuito a valle nel caso in cui venga a mancare la sorgente di pressione, abbinata alla possibilità di scaricare direttamente l'aria in atmosfera senza necessariamente far ripercorrere il flusso in senso inverso. L'applicazione tipica per questo prodotto è direttamente installato in prossimità o direttamente sulla bocca di un cilindro avendo quindi la possibilità di mantenere la camera in pressione nel caso venga a mancare il segnale di pilotaggio con in più la possibilità di scaricare rapidamente la pressione presente nella camera stessa nel momento in cui si pilota la valvola di blocco.
- Le tipologie di combinazioni sono:
- Valvola di blocco unidirezionale + valvola di scarico rapido
- Valvola di blocco bidirezionale + valvola di scarico rapido

Caratteristiche tecniche

Fluido	Aria filtrata e lubrificata o non
Connessioni di alimentazione	Vedi LISTA Connessioni di alimentazione
Pressione di funzionamento max. (bar)	0,5 ÷ 10
Temperatura di esercizio in °C	-5 ÷ + 50
Portata a 6 bar con Δp=1 (NI/min)	285
Peso (gr.)	51

Construction characteristics

- The combination of this two functions ensures that the downstream pressure is maintained in case of accidental loss of supply pressure and at the same time allows for the air to be directly discharged into the atmosphere without going through the pneumatic circuit. A typical application of this combination is close to or directly assembled onto the actuator connection ports. This allows to keep pressurised the cylinder chamber in case of accidental loss of supply pressure and to quickly discharge the same chamber when the blocking valve is actuated.
- The possible combination are the following:
- unidirectional blocking valve + quick exhaust valve
- bidirectional blocking valve + quick exhaust valve

Technical characteristics

Fluid	Filtered and lubricated air or not
Connections	See CONNECTIONS LIST
Max working pressure	0,5 ÷ 10 bar
Working temperature	-5°C ÷ +50°C
Flow rate at 6 bar with Δp=1	285 NI/min
Weight without connections	51 gr.

ART. 551.2GT.A.B.XX

 Valvole di blocco a 90° + VSR
 90° blocking valve + QEVac

TIPOLOGIA	VERSION
T 1 = Valvola di Blocco 90° Unidirezionale + scarico rapido 2 = Valvola di Blocco 90° Bidirezionale + scarico rapido	T 1 = 90° Unidirectional blocking valve + quick exhaust valve 2 = 90° Bidirectional blocking valve + quick exhaust valve
A Connessione A - Vedi LISTA	A Connection A - see LIST
B Connessione B - Vedi LISTA	B Connection B - see LIST
LISTA Connessioni	Connections LIST
00 = Non prevista	00 = None
D4 = Diritto Ø4	D4 = Straight Ø4
D6 = Diritto Ø6	D6 = Straight Ø6
D8 = Diritto Ø8	D8 = Straight Ø8
L1 = Anello girevole metallo G1/8"	L1 = Female banjo G1/8"
G4 = Anello PL girevole Ø4	G4 = Rotating banjo Ø4
G6 = Anello PL girevole Ø6	G6 = Rotating banjo Ø6
G8 = Anello PL girevole Ø8	G8 = Rotating banjo Ø8
M1 = G1/8 maschio	M1 = G1/8 male
M2 = G1/4 maschio	M2 = G1/4 male
F1 = G1/8 femmina	F1 = G1/8 female

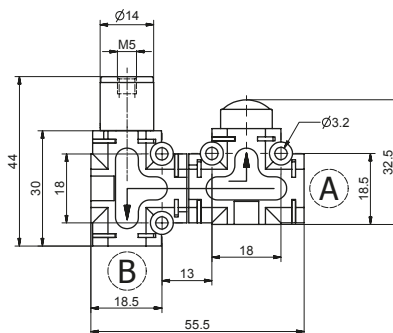

 NOTA: Per Ingombro con cartucce vedi pagina Connessioni di alimentazione
 Esempio: 5512G1.00.00.XX

Valvola di blocco a 90° + Scarico rapido. Connessioni di alimentazione "A" e "B" non previste.

NOTE: For the dimension including cartridges see page CONNECTIONS

Example: 551.2G1.00.00.XX

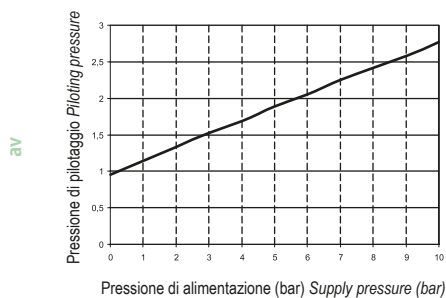
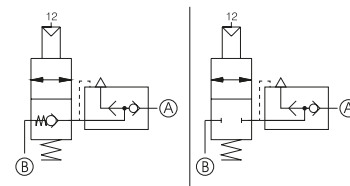
90° unidirectional blocking valve + quick exhaust valve, without CONNECTIONS "A" and "B"

 Simboli pneumatici
 Pneumatic Symbol

Caratteristiche costruttive

- L'utilizzo di queste 2 funzioni combinate consente di mantenere la pressione nel circuito a valle nel caso in cui venga a mancare la sorgente di pressione, abbinata alla possibilità di scaricare direttamente l'aria in atmosfera senza necessariamente far ripercorrere il flusso in senso inverso. L'applicazione tipica per questo prodotto è direttamente installato in prossimità o direttamente sulla bocca di un cilindro avendo quindi la possibilità di mantenere la camera in pressione nel caso venga a mancare il segnale di pilotaggio con in più la possibilità di scaricare rapidamente la pressione presente nella camera stessa nel momento in cui si pilota la valvola di blocco.
- Le tipologie di combinazioni sono:
- Valvola di blocco unidirezionale 90° + valvola di scarico rapido
- Valvola di blocco bidirezionale 90° + valvola di scarico rapido

Caratteristiche tecniche

Fluido	Aria filtrata e lubrificata o non
Connessioni di alimentazione	Vedi LISTA Connessioni di alimentazione
Pressione di funzionamento max. (bar)	0,5 ÷ 10
Temperatura di esercizio in °C	-5 ÷ +50
Portata a 6 bar con $\Delta p=1$ (NI/min)	285
Peso (gr.)	51

Construction characteristics

- The combination of this two functions ensures that the downstream pressure is maintained in case of accidental loss of supply pressure and at the same time allows for the air to be directly discharged into the atmosphere without going through the pneumatic circuit. A typical application of this combination is close to or directly assembled onto the actuator connection ports. This allows to keep pressurised the cylinder chamber in case of accidental loss of supply pressure and to quickly discharge the same chamber when the blocking valve is actuated.
- The possible combination are the following:
- 90° unidirectional blocking valve + quick exhaust valve
- 90° bidirectional blocking valve + quick exhaust valve

Technical characteristics

Fluid	Filtered and lubricated air or not
Connections	See CONNECTIONS LIST
Max working pressure	0,5 ÷ 10 bar
Working temperature	-5°C ÷ +50°C
Flow rate at 6 bar with $\Delta p=1$	285 NI/min
Weight without connections	51 gr.

ART. 551.1HT.A.B.XX

Rid. di pressione con indicatore
Pressure regulator + indicator

TIPOLOGIA	VERSION
T 2 = 0 - 2 bar 4 = 0 - 4 bar 8 = 0 - 8 bar	T 2 = 0 - 2 bar 4 = 0 - 4 bar 8 = 0 - 8 bar
A Connessione A - Vedi LISTA	A Connection A - see LIST
B Connessione B - Vedi LISTA	B Connection B - see LIST
LISTA Connessioni	Connections LIST
00 = Non prevista	00 = None
D4 = Diritto Ø4	D4 = Straight Ø4
D6 = Diritto Ø6	D6 = Straight Ø6
D8 = Diritto Ø8	D8 = Straight Ø8
L1 = Anello girevole metallo G1/8"	L1 = Female banjo G1/8"/8"
G4 = Anello PL girevole Ø4	G4 = Rotating banjo Ø4
G6 = Anello PL girevole Ø6	G6 = Rotating banjo Ø6
G8 = Anello PL girevole Ø8	G8 = Rotating banjo Ø8
M1 = G1/8 maschio	M1 = G1/8 male
M2 = G1/4 maschio	M2 = G1/4 male
F1 = G1/8 femmina	F1 = G1/8 female

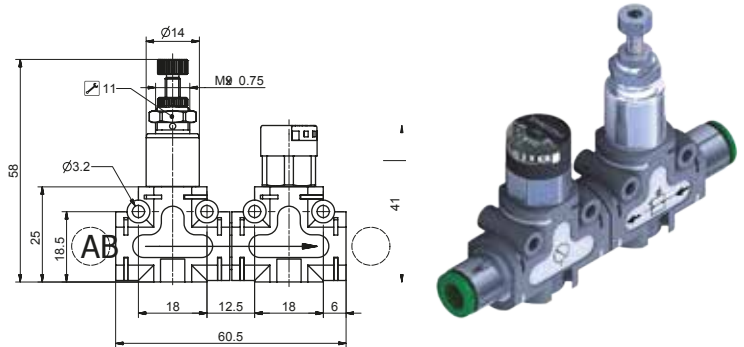

NOTA: Per Ingombro con cartucce vedi pagina Connessioni di alimentazione
Esempio: 551.1H2.M1.D4.XX
Riduttore di pressione in linea, Gamma di regolazione pressione 0 - 2 bar con indicatore di pressione. Connessioni di alimentazione "A" Maschio G 1/8 e "B" Tubo Ø4

NOTE: For the dimension including cartridges see page CONNECTIONS
Example: 551.1H2.M1.D4.XX
In line pressure regulator, adjusting range 0 - 2 bar + pressure indicator, CONNECTIONS "A" Male G 1/8 and "B" Tube Ø4

Simboli pneumatici
Pneumatic Symbol

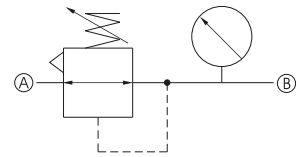

Caratteristiche costruttive

- L'utilizzo di queste 2 funzioni combinate consente di poter regolare la pressione a valle in un circuito visualizzando direttamente il valore di pressione impostato.
- Le possibili combinazioni sono:
- Riduttore di pressione 0 ÷ 2 bar + Indicatore di pressione
- Riduttore di pressione 0 ÷ 4 bar + Indicatore di pressione
- Riduttore di pressione 0 ÷ 8 bar + Indicatore di pressione
- Nota: l'indicatore di pressione è disponibile solo con fondo scala da 0 a 8 bar

Caratteristiche tecniche

Fluido	Aria filtrata e lubrificata o non
Connessioni di alimentazione	Vedi LISTA Connessioni di alimentazione
Pressione di funzionamento max. (bar)	8
Temperatura di esercizio in °C	-5 ÷ + 50
Scala di visualizzazione (bar)	0 ÷ 8
Gamma di regolazione della pressione (bar)	0 ÷ 2 - 0 ÷ 4 - 0 ÷ 8
Peso (gr.)	62

Construction characteristics

- The combination of this two functions ensures the possibility to regulate the downstream pressure while directly visualising the adjusted pressure value.
- The possible combinations are the following:
- 0 to 2 bar pressure regulator + pressure visual indicator
- 0 to 4 bar pressure regulator + pressure visual indicator
- 0 to 8 bar pressure regulator + pressure visual indicator
- the visual indicator pressure range is always 0 to 8 bar

Technical characteristics

Fluid	Filtered and lubricated air or not
Connections	See CONNECTIONS LIST
Max working pressure	8 bar
Working temperature	-5°C ÷ +50°C
Visualization scale	0 ÷ 8 bar
Regulated pressure range	0 ÷ 2 - 0 ÷ 4 - 0 ÷ 8
Weight without connections	62 gr.

ART. 55160

Kit perni più Crocette
Coupling kit (pins and forks)

Il kit composto da una serie di perni abbinata ad una serie di crocette di accoppiamento permette una facile, veloce e sicura unione di più componenti nelle più svariate configurazioni. L'inserimento dei perni negli appositi fori frontali, permette di contrastare eventuali forze applicate in modo perpendicolare ed in modo trasversale al componente (es. l'inserimento di un tubo nell'apposita cartuccia) così che il gruppo si mantenga assialmente stabile e ben allineato. L'inserimento delle crocette di accoppiamento nell'apposita fessura sagomata permette di mantenere il gruppo compatto garantendo l'unione dei componenti. Il kit permette di accoppiare un numero massimo di 5 elementi.

The kit, which includes a series of pins and forks, enables to join together in a fast and safe way the function fittings. The pins, once inserted in the front holes, ensure resistance against forces applied perpendicularly and sideways (for example the insertion of the tube in the cartridges). The forks, once located in the profiled housing ensures that the parts are held together tightly. The kit allows for 5 function fittings to be mounted together.

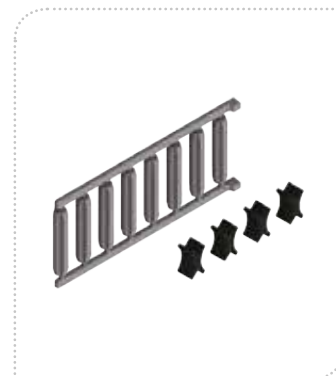

ART. 55150

Squadretta di fissaggio
Fixing brackets

Peso 18 gr.

Weight 18 gr.

Il kit comprende 2 elementi più viti di fissaggio

The kit comprises two fixing brackets and the

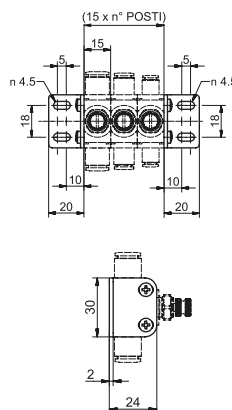

ART. 55116

Adattatore guida DIN
DIN rail adapter

Peso 4 gr.

Weight 4 gr.

Il kit comprende 2 elementi

The kit comprises two adapters

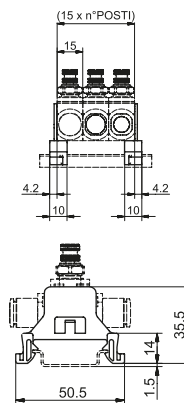

ART. 551KD

Cartuccia diritta
Straight cartridge

Peso 7,5 gr.

Weight 7,5 gr.

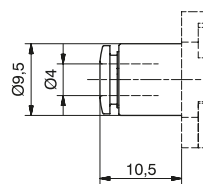

ART. 551KG

 Cartuccia gomito girevole
Banjo PL cartridge

Peso 13,6 gr.

Weight 13,6 gr.

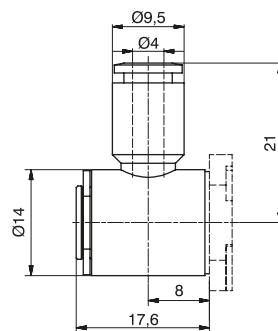
ART. 551KL

 Cartuccia gomito girevole G1/8"
G1/8" banjo female cartridge

Peso 30 gr.

Weight 30 gr.

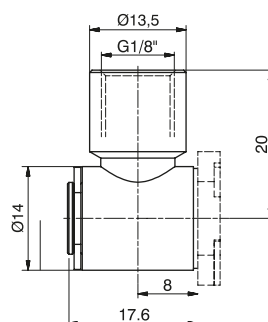
ART. 551KM1

 Cartuccia G1/8" Maschio
G1/8" male straight cartridge

Peso 14 gr.

Weight 14 gr.

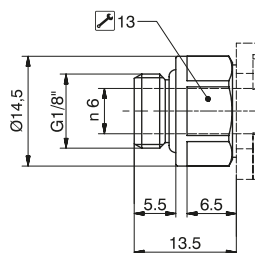
ART. 551KM2

 Cartuccia G1/4" Maschio
G1/4" male straight cartridge

Peso 20 gr.

Weight 20 gr.

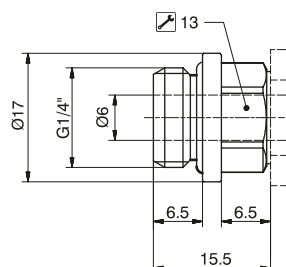

ART. 551KF1

Cartuccia G1/8" Femmina
G1/8" female straight cartridge

Peso 9 gr.

Weight 9 gr.

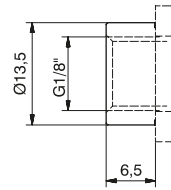

ART. 551KUU

Giunzione per funzioni multiple
Connection for multiple function

Peso 14 gr.

Weight 14 gr.

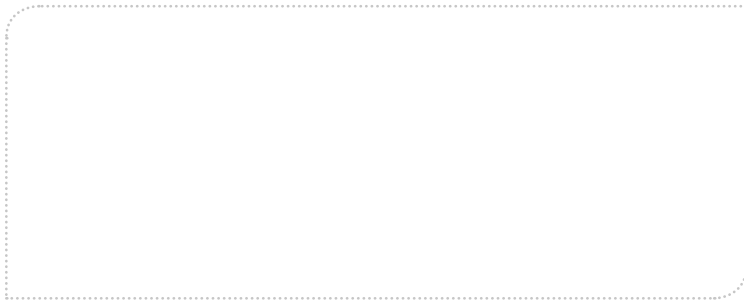

BREVE DESCRIZIONE

Nuova linea di componenti miniaturizzati che raccolgono varie funzioni logiche, utilizzabili in qualsiasi punto dei rami secondari dei circuiti pneumatici, indicati per essere applicati direttamente sui componenti pneumatici principali (distributori e cilindri).

Il sistema di composizione modulare permette di combinare fra di loro diverse funzioni logiche senza necessariamente mettere un tubo di collegamento tra gli elementi; lo stesso consente inoltre di poter scegliere il tipo di attacco su ciascuna delle bocche. Sono disponibili infatti svariate alternative: raccordi a innesto rapido diritti, raccordi a innesto rapido girevoli, nippli con filetto maschio G1/8" e G1/4" e nippli con filetto femmina G1/8". Gli elementi possono essere anche accoppiati in parallelo per essere poi agganciati su guida DIN EN 50022 (mediante apposito kit).

SHORT DESCRIPTION

New compact line of different logic functions that can be used in any place of the secondary pneumatic circuit, developed to be installed directly onto the main pneumatic components (distributors or cylinders).

Thanks to the modular design it is possible to easily join together multiple logic functions without the need of using pipes to connect them; it is also possible to choose the type and style of each connection.

The connections available are the following: straight cartridge; Banjo PL cartridge; male cartridge threaded 1/8" or 1/4" and female cartridge threaded 1/8".

Function fittings can also be assembled side by side in order to be assembled on the DIN EN 50022 rail (using the relevant kit).

SCHEDA TECNICA TECHNICAL SHEET

FLUIDI UTILIZZABILI <i>EMPLOYABLE FLUIDS</i>		Aria compressa (per altri fluidi contattare il nostro Ufficio Tecnico) <i>Compressed air (for different fluid pls contact our Technical Dept.)</i>
APPLICAZIONI <i>APPLICATIONS</i>		Impianti pneumatici secondo normativa DIN 3861-3870. <i>Pneumatic circuits according to DIN 3861-3870 norms.</i>
TUBI CONSIGLIATI <i>SUGGESTED TUBES</i>		TPU (Poliuretano), PA11/PA12 (Poliammide), TPE (Polietilene), TCO (Copoliestere) <i>TPU (Polyurethane), PA11/PA12 (Polyamide), TPE (Polyethylene), TCO (Copolyester)</i>
TOLLERANZE TUBI <i>TUBES TOLERANCES</i>		Diam. da 4 a 10 mm +/- 0,05 Diam. da 12 mm +/- 0,1 <i>Diam. between 4 and 10 mm +/- 0,05 Diam. from 12 mm +/- 0,1</i>
TEMPERATURE E PRESSIONI <i>TEMPERATURE AND PRESSURE</i>		Le temperature e le pressioni dipendono generalmente dalle caratteristiche del tubo impiegato; per dati più puntuali consultare il catalogo tecnico del proprio fornitore di tubi. <i>Temperatures and pressures usually depend by the technical features of the employed tubes, for more complete informations pls read the technical catalogue of your tube supplier.</i>
FILETTATURE <i>THREAD TYPE</i>		BSP cilindrica UNI-ISO 228 <i>BSP parallell UNI-ISO 228</i>
MATERIALI <i>MATERIALS</i>	corpo centrale <i>main body</i>	IXEF, tecnopolimero caricato in vetro <i>IXEF, technopolymer glass-fiber reinforced</i>
	corpo raccordo, spintore, distanziale, sottomolla <i>fitting body, sleeve, collar and back ring</i>	POM copolimero ISO1043-1 <i>POM copolymer ISO1043-1</i>
	vite di regolazione e raccordo <i>adjustment screw and fitting</i>	Ottone UNI EN 12164 CW614N <i>Brass UNI EN 12164 CW614N</i>
	corpo cartuccia <i>cartridge body</i>	Alluminio <i>Alluminium</i>
	pinza <i>spring</i>	Acciaio Inox AISI 301 austenitico <i>Stainless steel AISI 301 austenitic</i>
	guarnizioni tenuta <i>seals</i>	NBR 70 DWGV-EN549 UL157 <i>NBR 70 DWGV-EN549 UL157</i>

INFORMAZIONI TECNICHE AGGIUNTIVE

Conessioni di ingresso / utilizzo direttamente integrate nel corpo
Versioni con attacchi in linea e 90°
Possibile abbinamento in parallelo
Diverse possibilità di connessione: - Tubo $\varnothing 4$ $\varnothing 6$ $\varnothing 8$ (anche nella versione girevole) - Filetto maschio G1/8" G1/4" - Filetto femmina G1/8" nella versione in linea oppure a 90°
Diverse possibilità di ancoraggio: - Fissaggio a parete mediante fori passanti - Su piastra mediante squadrette - A pannello (per le funzioni logiche che lo prevedono) - Su barra din EN 50022 (mediante kit di fissaggio)
Funzioni previste: - Regolatore di flusso (RFU) - Riduttore di pressione (RP) - Valvola di blocco (VB) - Valvola di scarico rapido (VSR) - Valvola Selettiva OR (VS-OR) - Valvola Selettiva AND (VS-AND) - Indicatore di pressione (IP) - Riduttore di pressione + Indicatore di pressione (RP+IP) - Valvola di blocco + Regolatore di flusso (VB+RFU) - Valvola di blocco + Valvola di scarico rapido (VB+VSR).

ADDITIONAL TECHNICAL INFORMATIONS

<i>Input/output connection directly integrated into the body</i>
<i>In line or 90° connection</i>
<i>Possibility to build a manifold -parallel mounting-</i>
<i>Different connection options:</i> - <i>Tube $\varnothing 4$ $\varnothing 6$ $\varnothing 8$ (elbow version as well)</i> - <i>G1/8" G1/4" male straight cartridge</i> - <i>G1/8" female cartridge, in line or 90°</i>
<i>Different mounting options:</i> - <i>Wall fixing through the holes in the body</i> - <i>By means of the fixing bracket</i> - <i>Panel mounting (for those function that include such possibility)</i> - <i>On DIN rail EN 50022 (using the DIN rail adapter kit)</i>
<i>Available functions:</i> - <i>Flow control valve (FCV)</i> - <i>Pressure regulator (PR)</i> - <i>Block valve (BV)</i> - <i>Quick exhaust valve (QEV)</i> - <i>OR gate (CSV-OR)</i> - <i>AND gate (CSV-AND)</i> - <i>pressure gauge (PI)</i> - <i>pressure regulator + pressure gauge (PR+PI)</i> - <i>block valve + Flow control valve (BV+FCV)</i> - <i>block valve + quick exhaust valve (BV+QEV).</i>

Raccordi di arresto • *Stop fittings*

 Caratteristiche
Features

- Il passaggio dell'aria si interrompe quando il tubo viene estratto e si riavvia nuovamente solo una volta che il tubo è reinserito
- *Air flows is stopped from the tube if it is released, the air flows again only after the tube is connected*

 Specifiche tecniche
Specifications

Fluido / Fluid	Aria / Air
Pressione di esercizio Operation pressure	0,1-1,0Mpa (150psi)
Pressione negativa Negative pressure	-100Kpa (-29,5 in Hg)
Temperatura di esercizio Operating temperature	0-60 °C (32-140 °F)
Tubo utilizzabile Applicable tube	Poliuretano, Poliammide e Nylon <i>Polyurethane and Nylon</i>

 Applicazioni
Applications

- Utilizzato in casi di frequenti disinnesti/cambio di tubo
- *Used in the place where tube frequently changes*

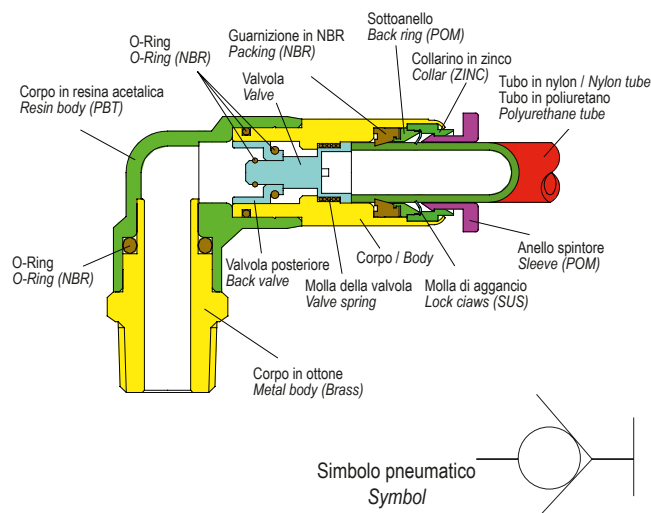
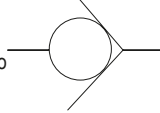
 Sezione costruttiva
Structure chart

 Simbolo pneumatico
Symbol

ART. ISPC

 Raccordo diritto maschio conico "di arresto"
Straight male tapered "stop fitting"

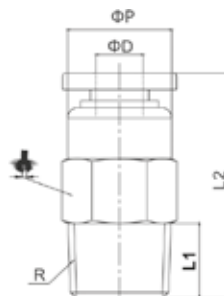
CODICE	A	B	C	L		
ISPC04-01	4	1/8	7,5	27,5	10	10
ISPC06-01	6	1/8	7,5	27	12	12
ISPC06-02	6	1/4	9,5	27	12	14
ISPC08-01	8	1/8	7,5	29	14	14
ISPC08-02	8	1/4	9,5	29	14	14
ISPC08-03	8	3/8	10,5	29	14	17
ISPC10-02	10	1/4	9,5	37	17	17
ISPC10-03	10	3/8	10,5	37	17	17
ISPC10-04	10	1/2	13,5	37	17	21
ISPC12-02	12	1/4	9,5	38	20	21
ISPC12-03	12	3/8	10,5	38	20	21
ISPC12-04	12	1/2	13,5	38	20	21



ART. ISPC-G

 Raccordo diritto maschio cilindrico "di arresto"
Straight male parallel "stop fitting"

CODICE	ØD	G	ØD1	L1	L2	
ISPC04-G01	4	1/8	10	5,5	27,5	14
ISPC06-G01	6	1/8	12	5,5	27	14
ISPC06-G02	6	1/4	12	7,5	27	17
ISPC08-G01	8	1/8	14	5,5	29	14
ISPC08-G02	8	1/4	14	7,5	29	17
ISPC08-G03	8	3/8	14	7,5	29	20
ISPC10-G02	10	1/4	17	7,5	37	17
ISPC10-G03	10	3/8	17	7,5	37	20
ISPC10-G04	10	1/2	17	10	37	24
ISPC12-G02	12	1/4	20	7,5	38	21
ISPC12-G03	12	3/8	20	7,5	38	21
ISPC12-G04	12	1/2	20	10	38	24

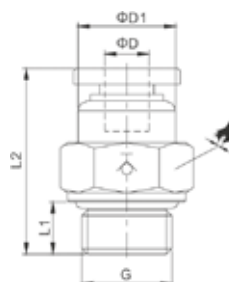

Raccordi di arresto • *Stop fittings*

ART. ISPU

Raccordo diritto intermedio "di arresto"
Stop fitting straight connector

CODICE	ØD	R	L
ISPU04	4	13	47
ISPU06	6	13	45
ISPU08	8	15	49,5
ISPU10	10	19	63
ISPU12	12	21,5	66,5

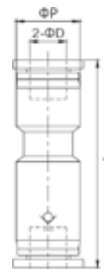

ART. ISPL

Raccordo ad L maschio conico "di arresto"
L male tapered "stop fitting"

CODICE	ØD	R	L1	L2	L3	Øp	↻
ISPL04-M5	4	M5	3,5	21,3	31	13	10
ISPL04-M6	4	M6	4	21,8	31	13	10
ISPL04-01	4	1/8	7,5	23,8	31	13	10
ISPL06-M5	6	M5	3,5	21,7	29,4	13	12
ISPL06-M6	6	M6	4	22,2	29,4	13	12
ISPL06-01	6	1/8	7,5	24,2	29,4	13	12
ISPL06-02	6	1/4	9,5	26,7	29,4	13	14
ISPL08-01	8	1/8	7,5	27,5	33	14,5	14
ISPL08-02	8	1/4	9,5	29,5	33	14,5	14
ISPL08-03	8	3/8	10,5	31	33	14,5	17
ISPL10-02	10	1/4	9,5	34,3	42,5	18	17
ISPL10-03	10	3/8	10,5	35,3	42,5	18	17
ISPL10-04	10	1/2	13,5	38,8	42,5	18	21
ISPL12-02	12	1/4	9,5	36	46,5	21	21
ISPL12-03	12	3/8	10,5	37	46,5	21	21
ISPL12-04	12	1/2	13,5	40	46,5	21	21

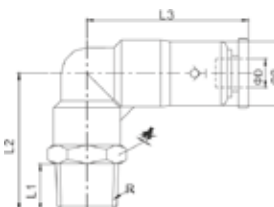

ART. ISPL-G

Raccordo ad L maschio cilindrico "di arresto"
L male parallel "stop fitting"

CODICE	ØD	G	L1	L2	L3	Øp	↻
ISPL04-G01	4	1/8	5,5	24,3	31	13	14
ISPL06-G01	6	1/8	5,5	24,2	29,4	13	14
ISPL06-G02	6	1/4	7,5	26,7	39,4	13	17
ISPL08-G01	8	1/8	5,5	27	33	14,5	14
ISPL08-G02	8	1/4	7,5	29,5	33	14,5	17
ISPL08-G03	8	3/8	7,5	30	33	14,5	20
ISPL10-G02	10	1/4	7,5	34,3	42,5	18	17
ISPL10-G03	10	3/8	7,5	34,3	42,5	18	20
ISPL10-G04	10	1/2	10	37,8	42,5	18	24
ISPL12-G02	12	1/4	7,5	36	46,5	21	21
ISPL12-G03	12	3/8	7,5	36	46,5	21	21
ISPL12-G04	12	1/2	10	39	46,5	21	24

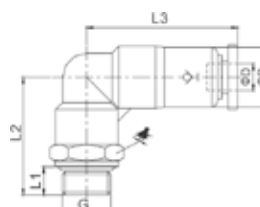

Valvole di ritegno • *Check valves*

 Caratteristiche
Features

- Specifiche: permette il passaggio dell'aria in una direzione ma lo impedisce nella direzione opposta
- *Specifications: allow the airflow in one direction but stops in the reverse direction*

 Specifiche tecniche
Specifications

Fluido / Fluid	Aria (non ammessi altri gas o liquidi) <i>Air (no other gases or liquids)</i>
Pressione di esercizio Operation pressure	0,05-1,0Mpa (150psi)
Pressione negativa Negative pressure	-100Kpa (-29,5 in Hg)
Temperatura di esercizio Operating temperature	0-60 °C (32-140 °F)
Tubo utilizzabile Applicable tube	Poliuretano, Poliammide <i>Polyurethane and Nylon</i>

 Metodo di verifica
Control method

Tipo <i>Type</i>	Modello IN (B) <i>Meter IN (B)</i>	Modello OUT <i>Meter OUT</i>
Direzione flusso Air Flow	Dal filetto al tubo <i>Thread to tube</i>	Dal tubo al filetto <i>Tube to thread</i>
PCVC		
PCVF		

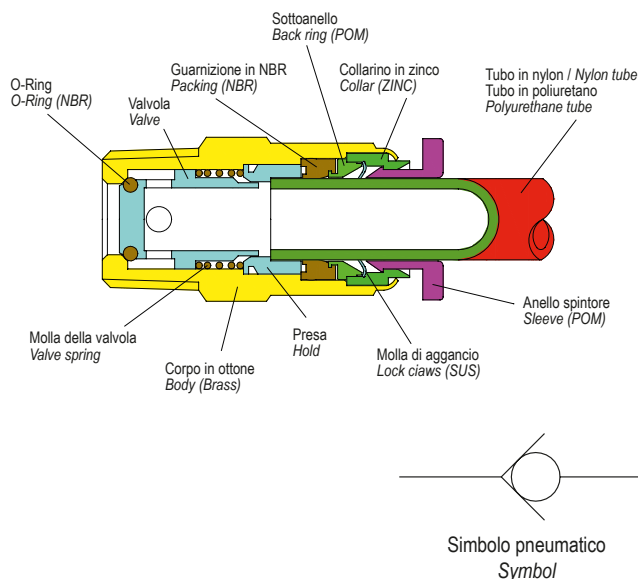
 Sezione costruttiva
Structure chart

 Avvertenze
Notes

Stringere il filetto secondo le regole. Non funzionerà se troppo stretto.
Tight the thread according to the rule. It won't work if too tight.

 Applicazioni
Applications

- Le valvole di ritegno permettono il passaggio dell'aria in una direzione
- *Check valves permit airflow in one direction*

ART. IPCVC

 Raccordo diritto maschio conico "unidirezionale"
Straight male tapered "unidirectional" fitting

CODICE	ØD	R	L1	L2	Øp	
IPCVC04-M5	4	M5	3,5	29	10	10
IPCVC04-M6	4	M6	4	30	10	10
IPCVC04-01	4	1/8	7,5	25	10	10
IPCVC06-01	6	1/8	7,5	26	12	12
IPCVC06-02	6	1/4	9,5	33	12	14
IPCVC08-01	8	1/8	7,5	28,5	14	14
IPCVC08-02	8	1/4	9,5	34,8	14	14
IPCVC08-03	8	3/8	10,5	34,8	14	17
IPCVC10-02	10	1/4	9,5	39,5	17	17
IPCVC10-03	10	3/8	10,5	41	17	17
IPCVC10-04	10	1/2	13,5	43	17	21
IPCVC12-02	12	1/4	9,5	41	20	21
IPCVC12-03	12	3/8	10,5	42,5	20	21
IPCVC12-04	12	1/2	13,5	44,5	20	21

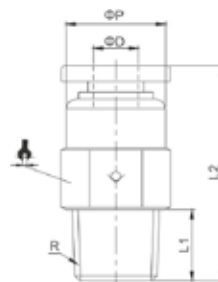

Valvole di ritegno • *Check valves*

ART. IPCVC-G Raccordo diritto maschio cilindrico "unidirezionale"
Straight male parallel "unidirectional" fitting

CODICE	ØD	G	ØD1	L1	L2	
IPCVC04-G01	4	1/8	10	5,5	24	14
IPCVC06-G01	6	1/8	12	5,5	26	14
IPCVC06-G02	6	1/4	12	7,5	33	17
IPCVC08-G01	8	1/8	14	5,5	28,5	14
IPCVC08-G02	8	1/4	14	7,5	34,8	17
IPCVC08-G03	8	3/8	14	7,5	34,8	20
IPCVC10-G02	10	1/4	17	7,5	39,5	17
IPCVC10-G03	10	3/8	17	7,5	41	20
IPCVC10-G04	10	1/2	17	10	43	24
IPCVC12-G02	12	1/4	20	7,5	41	21
IPCVC12-G03	12	3/8	20	7,5	42,5	21
IPCVC12-G04	12	1/2	20	10	42,5	24

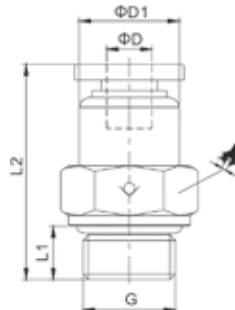

ART. IPCVF Raccordo maschio/femmina conico "unidirezionale"
Tapered male/female "unidirectional" fitting

CODICE	R	G	L1	L2	L	
IPCVF-01-01	1/8	1/8	7,5	8,5	23	14
IPCVF-02-02	1/4	1/4	9,5	11	29,8	17
IPCVF-03-03	3/8	3/8	10,5	12	32,9	21
IPCVF-04-04	1/2	1/2	13,5	14	37	24

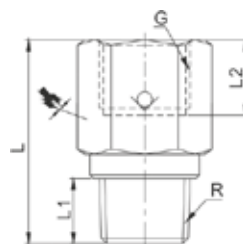

ART. IPCVF-G Raccordo maschio/femmina cilindrico "unidirezionale"
Parallel male/female "unidirectional" fitting

CODICE	G	L1	L2	L	
IPCVF-01-G01	1/8	5,5	8,5	23	14
IPCVF-02-G02	1/4	7,5	11	29,8	17
IPCVF-03-0G3	3/8	7,5	12	32,9	21
IPCVF-04-G04	1/2	10	14	37	24

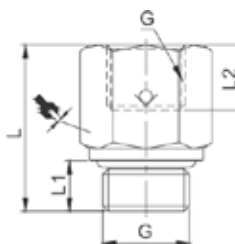

ART. IPCVU Raccordo diritto intermedio "unidirezionale"
Unidirectional straight connector

CODICE	ØD	Øp	L
IPCVU04	4	13	47
IPCVU06	6	13,5	21,5
IPCVU08	8	15	53
IPCVU10	10	19	62
IPCVU12	12	21,5	64

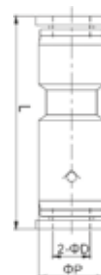

Valvole di scarico rapido con regolatore di flusso e silenziatore Quick exhaust valves with speed control and silencer

Caratteristiche Features

- Utilizzate con cilindri ad alta velocità
- La valvola di scarico integra un raccordo rapido per l'innesto facilitato del tubo
- La valvola ha anche la funzione di valvola selettiva
- Lo scarico ha la funzione di eliminazione dello strozzamento e del rumore
- Esso può controllare il cilindro ad alta velocità e al tempo stesso ridurre il rumore dello scarico
- *Used to the high-speed cylinders*
- *The exhaust valve with a quick fittings to fix the tube easily*
- *The valve have the function of the shuttle valve*
- *The exhaust side have the function with throttling and noise elimination.*
- *It can control the high-speed cylinder, at the same time also can reduce the exhaust noise*

Sezione costruttiva Structure chart

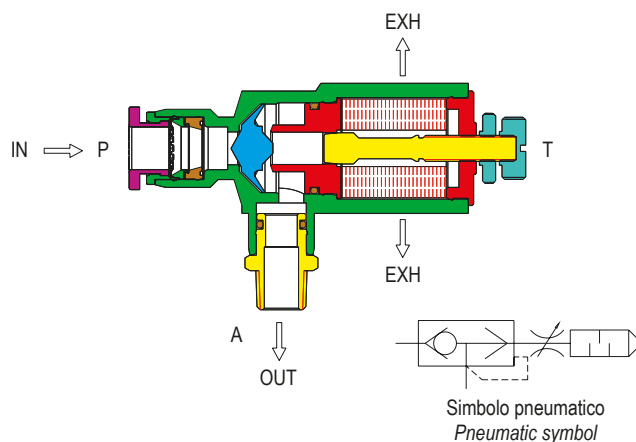

Principio operativo Operation principle

Come sopra illustrato nel disegno sezionato, la valvola ha tre porte P, A e T. L'aria entra dall'ingresso P, ed esce da A verso l'attuatore, o T dal silenziatore. Quando l'aria compressa entra dall'ingresso P spinge la valvola-N verso destra, in questo modo si ha il passaggio da P verso A e l'aria sarà disponibile per l'attuatore. Quando non c'è ingresso di aria compressa da P, l'aria di ritorno dall'attuatore spinge la valvola-N verso sinistra, e chiude la porta P, l'aria può passare da A verso T e scaricarsi rapidamente. La valvola di scarico rapido è sempre usata come valvola selettiva sul cilindro, l'aria può essere scaricata rapidamente senza passare attraverso questa funzione che, in questo modo, consente un moto alternato del cilindro più veloce riducendo i tempi di lavoro. Il lato di scarico T ha la funzione di eliminare lo strozzamento e il rumore. Può dunque controllare il cilindro ad alta velocità e allo stesso tempo è anche in grado di ridurre il rumore di scarico.

As above drawing shown, it with three valve ports P, A, T. The air input from P, A with the actuator, T through the air. When the compressed air input from P, which will push the N-holder to the right way, the air can be through between P and A, air will be offered to the actuator; When no compressed air input from P, the air from the actuator will push the N-holder to the left way, and stop P, the air can be through between A and T, also exhaust the air from T quickly. The quick exhaust valve always used to the shuttle valve and cylinder, the air can be exhaust quickly and not through the shuttle valve, which fast the reciprocating motion on the cylinder and short the work period. The exhaust side T have the function with throttling and noise elimination. It can control the high-speed cylinder, at the same time also can reduce the exhaust noise.

Specifiche tecniche Specifications

Fluido / Fluid	Aria / Air
Pressione di esercizio Operation pressure	0,1-1,0Mpa
Temperatura di esercizio Operating temperature	0-60 °C
Tubo utilizzabile Applicable tube	Poliuretano, Poliammide e Nylon Polyurethane and Nylon

ART. ISE

VSR + RFV filetto conico
VSR + RFV taper thread

CODICE	ØD	R	L1	L2	L3	L4 Max	ØD1	ØD2	S
ISE08-01	8	1/8	7,5	31	29	83	15	25	12
ISE08-02	8	1/4	9,5	34	29	83	15	25	14
ISE08-03	8	3/8	10,5	35,5	29	83	15	25	17
ISE10-01	10	1/8	7,5	31	32	86	19	25	12
ISE10-02	10	1/4	9,5	34	32	86	19	25	14
ISE10-03	10	3/8	10,5	35,5	32	86	19	25	17

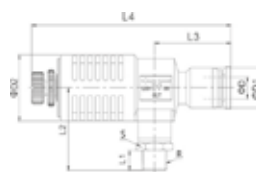

ART. ISE-G

VSR + RFV filetto cilindrico
VSR + RFV parallel thread

CODICE	ØD	G	L1	L2	L3	L4 Max	ØD1	ØD2	S
ISE08-G01	8	1/8	5,5	30	29	83	15	25	13
ISE08-G02	8	1/4	6,5	31,5	29	83	15	25	16
ISE08-G03	8	3/8	7,5	33	29	83	15	25	20
ISE10-G01	10	1/8	5,5	30	32	86	19	25	13
ISE10-G02	10	1/4	6,5	31,5	32	86	19	25	16
ISE10-G03	10	3/8	7,5	33	32	86	19	25	20

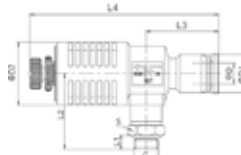





TUBI E ACCESSORI

ART. TPU

 Tubo Poliuretano
 Polyurethane tube



CODICE	Dxd mm.	P bar	P1 bar	R mm.		
TPU0315	3 x 1,5	13,5	54	7,5	200	25
TPU0402	4 x 2	15	60	11	100	25
TPU0425	4 x 2,5	10(10)	40(40)	15	100	25
TPU0604	6 x 4	10	40(36)	18	100	25
TPU0805	8 x 5	13	52	25	100	25
TPU0855	8 x 5,5	9 (8)	37 (34)	30	100	25
TPU0806	8 x 6	7	28	35	100	25
TPU1065	10 x 6,5	10(7)	40(28)	30	100	25
TPU1075	10 x 7,5	6,5(6)	27(25)	40	100	25
TPU1008	10 x 8	5,5	22	45	100	25

Nota: i dati fra parentesi si riferiscono alle misure disponibili anche nelle colorazioni traslucide (durezza 95 shoreA).

Notice: data between parenthesis refer to cristal colour types (hardness 95 shoreA).

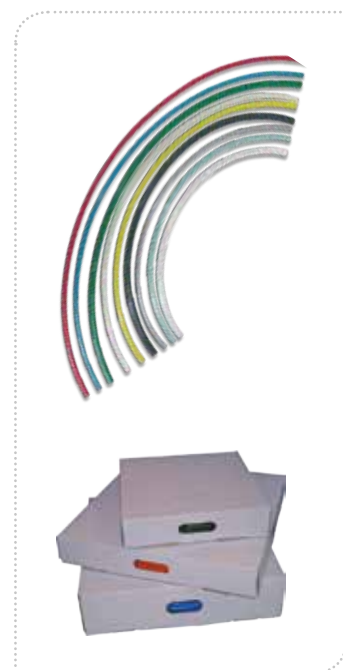
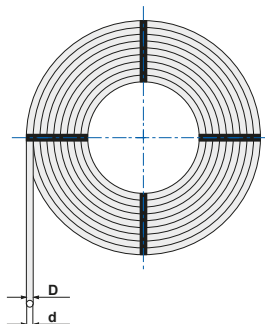
[] = Neutro/Neutral, [B] = Nero/Black, [BU] = Azzurro/Light Blue, [G] = Verde/Green, [R] = Rosso/Red, [GR] = Grigio/Grey, [T] = Trasparente/Cristal, [Y] = Giallo/Yellow



- D = diametro esterno – external diameter
 d = diametro interno – internal diameter
 P = pressione di esercizio – working pressure
 P1 = pressione di scoppio – breaking pressure
 R = raggio di curvatura – bending radius
 = rotolo confezione – roll packing
 = scatola cartone – cartoon box

 Scala di correzione in funzione della Temperatura
 Adjusting scale on atmospheric temperature basis

Tabella di correzione dei valori della pressione di utilizzo
 in funzione della variazione di temperatura
 Correction value scale for working pressure
 in consideration of the temperature variation



Temperatura Temperature	-20°C	0°C	+23°C	+30°C	+40°C	+50°C	+60°C	+70°C
Coefficiente Coefficient	x 1,87	x 1,4	x 1	x 0,84	x 0,70	x 0,60	x 0,52	x 0,47

Nella scelta dell'applicazione l'utilizzatore deve tenere conto delle variabili d'uso (pressione, temperatura, condizioni ambientali) e di tutto quello che può interferire nell'applicazione. Queste informazioni sono pertanto solo indicative. La validazione delle applicazioni è sempre a carico dell'utilizzatore. Medifly si riserva il diritto di modificare o aggiornare i dati tecnici qui riportati in qualsiasi momento senza obbligo di notifica. Questo documento non ha valenza contrattuale.

In the application choice the user must keep in mind the different use variables (pressure, temperature, environment conditions) and all the things that can interfere with the application. These information must be considered only as a general indication. The validation of the application is always at the user charge. Medifly keeps the right to modify or adjourn the technical data in any moment without notify duty. This document has no contract value.

ART. PA12



Tubo Poliammide
Polyamide tube

CODICE	Dxd mm.	P bar	P1 bar	R mm.		
PA120402 (*)	4 x 2	37	130	20	100	25
PA120425	4 x 2,5	32	112	20	100	25
PA120427	4 x 2,7	23	80	25	100	25
PA120604	6 x 4	26	90	30	100	25
PA120806	8 x 6	20	70	40	100	25
PA121007 (*)	10 x 7	25	88	70	100	25
PA121008	10 x 8	15	52	60	100	25
PA121210	12 x 10	12	42	85	100	25
PA121412	14 x 12	11	33	90	100	25

Nota: le misure contrassegnate con asterisco sono disponibili solo su richiesta.
Notice: (*) = sizes available on demand only.

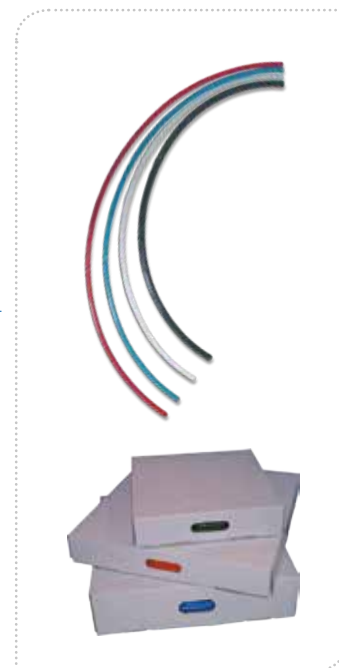
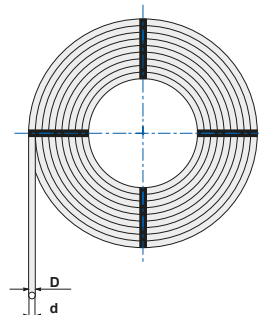
[N] = Neutro/Neutral, [B] = Nero/Black, [BU] = Azzurro/Light Blue.



- D = diametro esterno – external diameter
- d = diametro interno – internal diameter
- P = pressione di esercizio – working pressure
- P1 = pressione di scoppio – breaking pressure
- R = raggio di curvatura – bending radius
-  = rotolo confezione – roll packing
-  = scatola cartone – carton box

Scala di correzione in funzione della Temperatura
Adjusting scale on atmospheric temperature basis

Tabella di correzione dei valori della pressione di utilizzo
in funzione della variazione di temperatura
Correction value scale for working pressure
in consideration of the temperature variation

Temperatura Temperature	-20°C	0°C	+23°C	+30°C	+40°C	+50°C	+60°C
Coefficiente Coefficient	x 1,87	x 1,4	x 1	x 0,90	x 0,80	x 0,70	x 0,60

Nella scelta dell'applicazione l'utilizzatore deve tenere conto delle variabili d'uso (pressione, temperatura, condizioni ambientali) e di tutto quello che può interferire nell'applicazione. Queste informazioni sono pertanto solo indicative. La validazione delle applicazioni è sempre a carico dell'utilizzatore. Medifly si riserva il diritto di modificare o aggiornare i dati tecnici qui riportati in qualsiasi momento senza obbligo di notifica. Questo documento non ha valenza contrattuale.

In the application choice the user must keep in mind the different use variables (pressure, temperature, environment conditions) and all the things that can interfere with the application. These information must be considered only as a general indication. The validation of the application is always at the user charge. Medifly keeps the right to modify or adjourn the technical data in any moment without notify duty. This document has no contract value.



ART. TPA

 Tubo Poliuretano/Copoliestere ALLOY SOFT
 Polyurethane tube/Copolyester ALLOY SOFT

CODICE	Dxd mm.	P bar	P1 bar	R mm.		
TPA0425	4 x 2,5	18	72	12	100	100
TPA0604	6 x 4	14	56	15	100	100
TPA0806 (*)	8 x 6	10	40	25	100	100
TPA1008 (*)	10 x 8	8	34	35	100	100
TPA1209	12 x 9	8	34	45	100	100
TPA1411	14 x 11	6	24	120	100	100
TPA1412	14 x 12	3	12	160	100	100
TPA1612	16 x 12	5,5	22	150	100	100

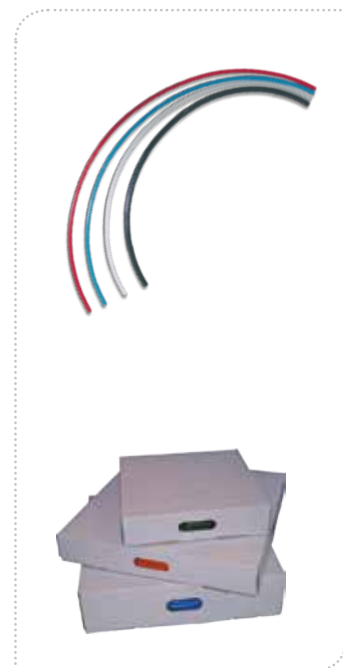
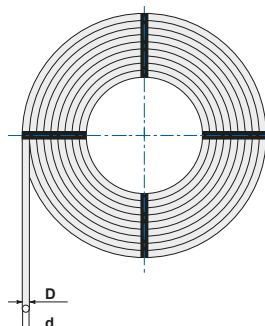
(*) disponibile anche nella versione PLUS con diametro interno minorato di 0,3 mm .
 disponibile solo azzurro ad eccezione della misura 12x9 fornibile nei seguenti colori:
 [N] = Neutro/Neutral, [B] = Nero/Black, [BU] = Azzurro/Light Blue, [G] = Verde/Green, [R] = Rosso/Red, [GR] = Grigio/Grey, [TB] = Blu traslucido/Cristal blue, [Y] = Giallo/Yellow



- D = diametro esterno – external diameter
 d = diametro interno – internal diameter
 P = pressione di esercizio – working pressure
 P1 = pressione di scoppio – breaking pressure
 R = raggio di curvatura – bending radius
 = rotolo confezione – roll packing
 = scatola cartone – cartoon box

 Scala di correzione in funzione della Temperatura
 Adjusting scale on atmospheric temperature basis

Tabella di correzione dei valori della pressione di utilizzo
 in funzione della variazione di temperatura
 Correction value scale for working pressure
 in consideration of the temperature variation

Temperatura Temperature	-20°C	0°C	+23°C	+30°C	+40°C	+60°C	+70°C	+70°C
Coefficiente Coefficient	1,87	1,4	1	0.90	0.80	0.70	0.50	x 0,47

TUBO POLIURETANO

Materiale dalle eccezionali caratteristiche meccaniche, questo tubo nasce per risolvere le problematiche legate ad applicazioni particolarmente gravose.

PROPRIETÀ TECNICHE:	Durezza Shore A	98
	Temperatura di applicazione	- 20°C +70°C
	Allungamento a rottura	540% (DIN 53504)
	Densità (gr./cm ³)	1.18 (DIN 53479)
	Perdita di abrasione (mm ²)	55 (DIN 53516)
	Resistenza allo strappo (KN/m)	120 (DIN 53515)

CARATTERISTICHE TECNICHE: Eccellente resistenza all'abrasione. Altissima flessibilità alle basse temperature. Buona resistenza agli agenti atmosferici. Buon invecchiamento nel tempo. Estremamente resistente alla fatica. Poco sensibile all'effetto "click" e "stress cracking".

ALTRE CARATTERISTICHE:
Tolleranze: Diametro esterno +/- 0,1 mm Spessore +/-0,1 mm
Colore: Azzurro, rosso, nero, verde, giallo, neutro, grigio, blu trasparente, cristallino
Confezione: Bobine da mt. 100

PRINCIPALI APPLICAZIONI: Robotica, Agricoltura, Pneumatica, Autofficine, ecc...

INFORMAZIONI GENERALI: I poliuretani, pur essendo molto resistenti alla fatica o alle tensioflessioni, hanno la tendenza ad accumulare calore laddove vengono impiegati con pressioni pulsanti continue. Se tali condizioni si verificano in concomitanza con un'elevata temperatura ambiente, possono verificarsi rigonfiamenti o addirittura rotture del tubo, caratteristica che si evidenzia specialmente nelle misure 8x6, 10x8, 14x12. Il poliuretano è in generale resistente all'ozono, idrocarburi, olii grassi, carburanti e soluzioni chimiche moderate. Non è resistente, o debolmente, ad acidi concentrati, ketoni, idrocarburi clorurati.

Sul tubo viene marcato il diametro int. x est., il tipo di materiale e il numero di lotto per la rintracciabilità. Ogni lotto di materiale viene accompagnato da certificato di conformità.

TUBO POLIAMMIDE

Il poliammide è tra i materiali più diffusi nelle applicazioni tecniche per le sue caratteristiche di flessibilità, prestazioni meccaniche come specificato di seguito.

CARATTERISTICHE: Elevate proprietà meccaniche alla trazione ed alla flessione continua ed alterna, notevole flessibilità, buona stabilità al calore, notevole resistenza all'invecchiamento, basso assorbimento d'acqua, notevole resistenza agli idrocarburi e olii e buona inerzia agli agenti chimici.

PROPRIETÀ FISICHE/MECCANICHE	METODO DI PROVA	VALORE
Densità	ASTM D-792	1,03g/cm ³
Durezza	ASTM D-2240	65ShD
Allungamento alla rottura	ASTM-D638	>300%
Modulo elastico	ASTM D-790	410MPa
Temperature di applicazione	-	-40°C/+70°C

Tolleranze: Diametro esterno +/- 0,1 mm Spessore +/-0,1 mm
Colore: Azzurro, nero, rosso e neutro.
Confezione: Bobine da mt. 100

APPLICAZIONI: Questo tipo di materiale risulta essere particolarmente indicato per la realizzazione di tubi per pneumatica, robotica, utensileria, macchine industriali, ecc..., ovvero quando vi sia l'esigenza di una notevole flessibilità in special modo a freddo.

NORMATIVE: ISO 1874 - DIN 73378 - DIN 74324

TUBO POLIURETANO+COPOLIESTERE

Il "coex", copoliestere rivestito di poliuretano, è un materiale che ha fatto il suo ingresso nelle applicazioni pneumatiche negli ultimi anni, in particolare per venire incontro ad esigenze applicative e di reperibilità. Oggi costituisce una valida alternativa sia tecnica che economica ai tubi storicamente utilizzati.

CARATTERISTICHE: Altissima flessibilità anche alle basse temperature, ottimo ritorno elastico, poco sensibile all'effetto "click" e "stress cracking", eccellente resistenza all'abrasione, buona resistenza agli agenti atmosferici, buon invecchiamento nel tempo, estremamente resistente alla fatica, buona resistenza chimica, ottima resistenza all'olio di taglio e lubrificazione a basse/medie temperature.

PROPRIETÀ FISICHE/MECCANICHE	METODO DI PROVA	VALORE
Durezza	DIN 53505 - ISO868	95 ShA
Assorbimento acqua	a 23°C 50% r.h.	<1%
Densità	DIN 53479 - ISO1183	1,20 g/cm ²
Allungamento alla rottura	DIN 53504 - ISO37	500%
Modulo elastico a flessione	ASTN D790	110 Mpa
Perdita di abrasione	DIN 53516 - ISO4649	25 mm ³
Resistenza alla rottura	DIN 53504 - ISO37	55 Mpa
Temperatura di applicazione	-	40°C - +65°C

Tolleranze: Diametro esterno +/- 0,1 mm (+/- 0,15 dal diam. 10mm).
 Diametro interno +/- 0,2 mm (+/- 0,3 dal diam. 7,5mm).
Colore: Vedi tabella tecnica pag. xx
Confezione: Bobine da mt. 100

APPLICAZIONI: Tubi prodotti con questo materiale hanno tutte le credenziali per inserirsi nelle applicazioni pneumatiche, agricoltura, in generale quando sia richiesta resistenza a grassi, oli emulsionati, lubrificazione. L'uso con pressioni pulsanti può dare origine ad accumulo di calore.

POLYURETHANE TUBE

Materiale dalle eccezionali caratteristiche meccaniche, questo tubo nasce per risolvere le problematiche legate ad applicazioni particolarmente gravose.

TECHNICAL PROPERTY:	Hardness Shore A	98
	Temperature working range	- 20°C +70°C
	Breaking Elongation	540% (DIN 53504)
	Density (gr./cm ³)	1,18 (DIN 53479)
	Abrasion loss (mm ³)	55 (DIN 53516)
	Tensile strenght (N/mm ²)	120 (DIN 53515)

TECHNICAL FEATURES:	Excelent resistance at the abrasion
	Good resistance at the atmospheric effects
	Good process of becoming old
	High flexibility at the lowest temperatures
	Extremely endeavor resistance
	Very low "click" and "stress cracking" effects

OTHER FEATURES:	Tolerances:	O.D. +/-0,1 mm Thickness +/-0,1 mm
	Colours available:	Light blue, Red, Black, Green, Yellow, Neutral, Cristal blue, Cristal
	Packing:	100 mt. Rolls in plastic film

MAIN APPLICATIONS: Pneumatic, Robotic, agriculture, garage, etc.

GENERAL NOTICES: Polyurethane tube material has excelent mechanical features and it is particularly addressed to mostly solve the heavy applications. Anyway polyurethanes, although they are much resistant at the endeavor and at the flexion stress, trend to keep heat when working with continuous variable pressure and in case of high atmosphere temperature it could bring to the swelling or breaking of the tubing itself, specially on sizes 8x6, 10x8, 14x12. Polyurethane is normally also resistant to ozone, hydrocarbon, oils and greases, fuel and moderate chemical solutions. It is not, or very low, resistant to concentrated acids, ketons, esters and chloride hydrocarbons.

POLYAMIDE TUBE

The polyamide is the most diffused material among the technical applications for its characteristics of flexibility and mechanical performances.

CHARACTERISTICS: High mechanical properties to traction and to continuous & alternate flexion, notable flexibility, good stability to heat, notable resistance to ageing, low water absorption, notable resistance to hydrocarbons and oils and good inertness to chemical agents.

MECHANICAL/PHYSICAL PROPERTIES	TRIAL METHOD	VALUE
Density	ASTM D-792	1,03g/cm ³
Hardness	ASTM D-2240	65ShD
Elongation at break	ASTM-D638	>300%
Elastic modulus	ASTM D-790	410MPa
Working pressure	-	-40°C/+70°C

Tolerances: O.D. +/- 0,1 mm Thickness +/-0,1 mm
Colours available: Light blue, black, red and neutral.
Packing: 100 mt. Rolls in plastic film

APPLICATION: This kind of material is particularly indicated for the realization of tubing for pneumatic, robotic, steel, industrial machineries, ecc..., when there is the necessity of notable flexibility.

REFERENCE NORMS: ISO 1874 - DIN 73378 - DIN 74324

COPOLYESTER+POLYURETHANE TUBE

The "coex", copolyester coated with polyurethane, is a material that has made its entry into the pneumatic applications in the recent years, in particular to meet the needs of applications and availability. Today is a good alternative for both, technical and economic reasons, to the tubes historically used.

FEATURES: Very high flexibility also at low temperatures, excellent elastic return, low sensibility to "click" and "stress cracking" effect, excellent resistance to abrasion, good resistance to atmospheric agents, good aging, extremely resistant to fatigue, good chemical resistance, excellent resistance to cut and lubrication oil at low/medium temperature.

MECHANICAL/PHYSICAL PROPERTIES	TESTING METHOD	VALORE
Hardness	DIN 53505 - ISO868	95 ShA
Water absorption	a 23°C 50% r.h.	<1%
Density	DIN 53479 - ISO1183	1,20 g/cm ²
Elongation at break	DIN 53504 - ISO37	500%
Flexural elastic modulus	ASTN D790	110 Mpa
Abrasion loss	DIN 53516 - ISO4649	25 mm ³
Break resistance	DIN 53504 - ISO37	55 Mpa
Workin temperature	-	40°C - +65°C

Tolerances: External diameter +/- 0,1 mm (+/- 0,15 from diam. 10mm).
 Internal diameter +/- 0,2 mm (+/- 0,3 from diam. 7,5mm).

Colours available: See technical page xx
Packing: 100 mt. Rolls in plastic film

APPLICATION: Tubes made with this row material have all the credentials to fit in pneumatics, agriculture, in general when is required resistance with grease, emulsified oils, lubrication. The use with continuous pulsating pressures can create heat accumulation.

BREVE DESCRIZIONE

I tubi per aria compressa in poliuretano, poliammide a copoliestere sono realizzate in Italia, a garanzia di elevati standard di qualità, secondo le normative ISO di riferimento, e rispondono alle seguenti specifiche tecniche e applicative.

SHORT DESCRIPTION

The polyurethane, polyamide and copolyester tubes are produced in Italy according to the reference ISO norms as warranty of high quality level and answer to the followings technical specifications and applications.

SCHEDA TECNICA TECHNICAL SHEET

FLUIDI UTILIZZABILI <i>EMPLOYABLE FLUIDS</i>	Fluidi liquidi e gassosi, aria compressa (per specifiche contattare il nostro UT) <i>Liquids and gases, compressed air (for information contact our UT)</i>
APPLICAZIONI <i>APPLICATIONS</i>	Pneumatica, idraulica a bassa pressione, secondo normativa DIN 3861-3870 <i>Pneumatic circuits, low pressure hydraulic applications, according to DIN 3861-3870 norms</i>
RACCORDI DI COLLEGAMENTO <i>CONNECTING FITTINGS</i>	Le serie di raccordi Rap, Tecno-Rap e a seguire, illustrati nel catalogo "Greenline" sono tutti compatibili <i>Fittings Rap, Tecno-Rap series and further, illustrated on our "Greenline" catalogue are all suitable</i>
TEMPERATURE E PRESSIONI <i>TEMPERATURE AND PRESSURE</i>	Le temperature e le pressioni dipendono generalmente dalle caratteristiche del tubo e sono specificate nelle pagine successive <i>Temperatures and pressures usually depend by the features of the employed tubes and are detailed on the following pages</i>
MATERIALI <i>MATERIALS</i>	Poliuretano TPU Poliammide PA12 Poliuretano / Copoliestere TPA <i>Polyurethane TPU Polyamide PA12 Polyurethane / Copolyester TPA</i>

ART. PSVA

 Pinza tagliatubo in metallo
Metal tube cutter

CODICE	A	B	C	
PSVA853	130	40	63	1
PSVA854	185	55	88	1



ART. TPT

 Pinza tagliatubo in tecnopolimero
Technopolymer tube cutter

CODICE	A	B	C	
TPT0318AV	140	90	50	1

ART. TC

 Pinza tagliatubo in plastica
Plastic tube cutter

CODICE	Colore / Color	A	B	V	
TC (BU)	Azzurro / Blue	80.5	35	61	1

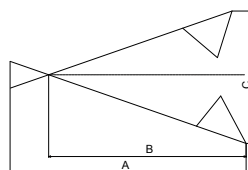
ART. MORS

 Morsettiere
Terminals

CODICE	Ø mm.	lunghezza length mm.	lunghezza width mm.	altezza height mm.	
706.004	4	185	14	9	10
706.006	6	215	14	13	10
706.008	8	235	14	15	10
706.010	10	275	14	17	10
706.012	12	305	14	19	10
706.015	15	276	14	21	8



BREVE DESCRIZIONE

Le pinze tagliatubo, realizzate in Italia nella versione metallica, e di importazione, nella versione in nylon, sono state concepite per essere utilizzate con tutti i tubi per l'aria e tutte le misure illustrate nel presente catalogo, per garantire tagli di precisione. Una perfetta tenuta pneumatica del raccordo necessita di un taglio pulito e senza bave del tubo; per questo è nata la sua nuova Pinza Tagliatubo "TPT", dotata di lama in acciaio di qualità "made in Germany" per migliaia di tagli garantiti, un unico utensile con cui tagliare perfettamente e con il minimo sforzo tubi in materiale plastico fino a 20 mm di diametro.

SHORT DESCRIPTION

The tube cutters, made in Italy in the metal version, and imported, in the plastic version, are designed to be used with all air hoses and measures shown in this catalog, they ensure precision cuts. A perfect pneumatic seal of the fitting requires a clean cut without burrs of the pipe; this is why the new "TPT" pipe cutter has been realized, equipped with a "made in Germany" quality steel blade for thousands of guaranteed cuts, a single tool for cutting perfectly and with minimal effort plastic pipes up to 20 mm in diameter.

SCHEDA TECNICA TECHNICAL SHEET

<p>PRECAUZIONI D'USO PRECAUTIONS</p>	<p>Tagliare il tubo perpendicolarmente all'asse, con una operazione decisa, avendo l'attenzione di evitare anomale inclinazioni del taglio che potrebbero compromettere il corretto inserimento del tubo nel raccordo e conseguentemente dare luogo ad eventuali perdite. Eliminare possibili bave interne ed esterne.</p> <p><i>Cut the tube at right angles to the axis, with a resolute operation, having the attention to avoid abnormal inclinations of the cut that may compromise the proper insertion of the tube into the fitting and consequently result in air leakage. Eliminate possible internal and external burrs.</i></p>
<p>MATERIALI MATERIALS</p>	<p>Corpo in materiale metallico pressofuso e cromato Corpo in materiale plastico (PA66-50%FV - POM) Lama (intercambiabile) in acciaio temprato ad alta resistenza.</p> <p><i>Body in chrome metal die-cast Body in plastic material (PA66-50%FV - POM) Blade (interchangeable) hardened high strenght steel.</i></p>

ART. SBE

Silenziatore a forma conica su base esagonale
Conical-shaped silencer on hexagonal base

CODICE	A	N	F	L	H		
SBE18	1/8" BSP	8	6	15	29	13	50
SBE14	1/4" BSP	8	7	17	32	16	50
SBE38	3/8" BSP	7	8	25	40	19	25
SBE12	1/2" BSP	9	9	27	45	24	25
SBE34	3/4" BSP	10	9	37	56	30	5
SBE01	1" BSP	10	11	45	66	36	5
SBE5MA	M5"	4	4	9	17	8	100
SBE18FEM	1/8" FEM BSP	8	7	15	30	13	50

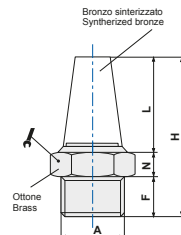

ART. SBT

Silenziatore a forma conica su base circolare
Conical-shaped silencer on a circular base

CODICE	A	E	F	L	H	N	
SBT18	1/8" BSP	12	6	15	25	4	100
SBT14	1/4" BSP	16	7	20	30	3	50
SBT38	3/8" BSP	19	8	27	38	3	25
SBT12	1/2" BSP	23	10	28	42	4	25
SBT34	3/4" BSP	29	10	38	52	4	5
SBT01	1" BSP	36	12	46	65,5	7,5	5

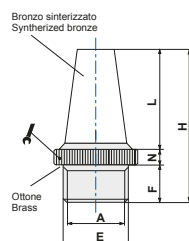

ART. SAC

Silenziatore a forma conica sottile su base esagonale
Thin conical silencer on hexagonal base

CODICE	A	N	F	L	H		
SAC18	1/8" BSP	8	6	30	44	13	100
SAC14	1/4" BSP	8	7	35	50	16	50
SAC38	3/8" BSP	7	8	39	54	19	25
SAC12	1/2" BSP	9	9	49	67	24	25
SAC34	3/4" BSP	10	9	46	65	30	5
SAC01	1" BSP	10	11	56	77	36	5
SAC5MA	M5"	4	4	18	26	8	100
SAC18FEM	1/8" FEM BSP	8	7	30	45	13	50

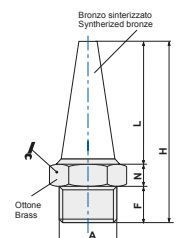

ART. SBTE-SBTT

Silenziatore con taglio cacciavite su base circolare
Silencer with screwdriver cut on a circular base

CODICE	A	E	F	L	H	N		
SBTT18	1/8" BSP	12	6	15	25	4	6	100
SBTT14	1/4" BSP	16	7	20	30	3	7	50
SBTT38	3/8" BSP	19	8	27	38	3	10	25
SBTT12	1/2" BSP	23	10	28	42	4	13	25
SBTT34	3/4" BSP	29	10	38	52	4	17	10
SBTT01	1" BSP	36	12	46	65,5	7,5	22	10
SBTE18	1/8" BSP	12	6	15	25	4	6	100
SBTE14	1/4" BSP	16	7	20	30	3	7	50
SBTE38	3/8" BSP	19	8	27	38	3	10	25
SBTE12	1/2" BSP	23	10	28	42	4	13	25
SBTE34	3/4" BSP	29	10	38	52	4	17	5
SBTE01	1" BSP	36	12	46	65,5	7,5	22	5

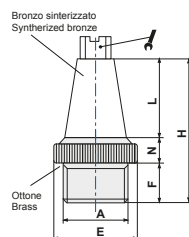

SBTE = Senza taglio
SBTE = Without screwdriver

ART. SPL

Silenziatore dinamico autopulente
Dynamic self-cleaning silencer

CODICE	A	B	F	L	H		
SPL18	1/8" BSP	15	8	27	35		100
SPL14	1/4" BSP	19,5	9	36	45		50
SPL38	3/8" BSP	24,5	11	47	58		50
SPL12	1/2" BSP	24,5	11	47	58		50
SPL34	3/4" BSP	48	18	96	114		10
SPL01	1" BSP	48	18	96	114		10

ART. SPLB

Silenziatore dinamico autopulente
Dynamic self-cleaning silencer

CODICE	A	B	F	L	H		
SPLB18	1/8" BSP	15	8	27	35		100
SPLB14	1/4" BSP	19,5	9	36	45		50
SPLB38	3/8" BSP	24,5	11	47	58		50
SPLB12	1/2" BSP	24,5	11	47	58		50
SPLB34	3/4" BSP	48	18	96	114		10
SPLB01	1" BSP	48	18	96	114		10

ART. SPLF

Silenziatore statico in feltro
Static felt silencer

CODICE	A	B	C	D	E		
SPLF18	1/8" BSP	28	16	6	34	10	100
SPLF14	1/4" BSP	36,5	19,5	6,5	43	13	50
SPLF38	3/8" BSP	46	24	10	56	17	50
SPLF12	1/2" BSP	46	24	10	56	17	50
SPLF34	3/4" BSP	95	48	16	111	(*)	10
SPLF01	1" BSP	95	48	16	111	(*)	10

(*) Taglio cacciavite Screwdriver cut

ART. SVE

Silenziatore con valvola regolatrice
Silencer with regulating valve

CODICE	A	min B max	C		
SVE18	1/8" BSP	20 - 22	6		50
SVE14	1/4" BSP	22 - 24	8		50
SVE38	3/8" BSP	25 - 28	10		25
SVE12	1/2" BSP	26 - 29	11		25
SVE34	3/4" BSP	32 - 37	12		5
SVE01	1" BSP	32 - 37	12		5

ART. RBP

Silenziatore con valvola regolatrice
Silencer with regulating valve

CODICE	A	min B max	C			
RBP18	1/8" BSP	14 - 19	6		12	50
RBP14	1/4" BSP	17 - 22	8		15	50
RBP38	3/8" BSP	18 - 24	9		19	25
RBP12	1/2" BSP	18 - 24	10,5		22	10

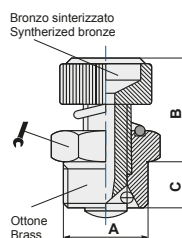
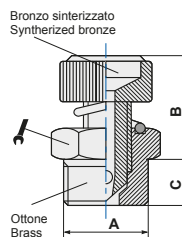
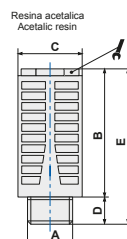
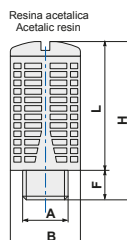
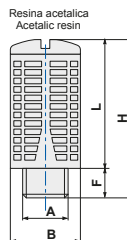

ART. SM

Smorzatore di pressione
Pressure damper

CODICE	A	L			
SM1018	1/8" BSP	30		14	50
SM2014	1/4" BSP	36		19	25
SM3038	3/8" BSP	45		27	25
SM4012	1/2" BSP	50		20	25

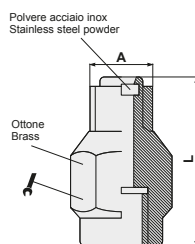

ART. SC

Silenziatore a forma conica su base circolare
Conical-shaped silencer on a circular base

CODICE	A	E	F	L	H		
SC18	1/8" BSP	12	6	15	21		100
SC14	1/4" BSP	15	6	19	25		50
SC38	3/8" BSP	19	8	28	36		25
SC12	1/2" BSP	23	10	33	43		25
SC34	3/4" BSP	29	13	40	53		5
SC01	1" BSP	36	15	48	63		5
SC5MA	M5"	6	4,5	8,5	13		100

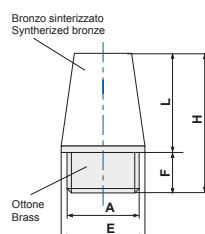

ART. SEB

Silenziatore a forma conica su base esagonale
Conical-shaped silencer on hexagonal base

CODICE	A	C	E	F	H		
SEB18	1/8" BSP	12,6	4,5	3,8	20,5	12	100
SEB14	1/4" BSP	16	6	4,5	26,5	15	50
SEB38	3/8" BSP	20	7	5,4	33,9	19	25
SEB12	1/2" BSP	24,5	8	7	40,5	23	25
SEB34	3/4" BSP	32	9	7,5	51,5	30	5
SEB01	1" BSP	38,5	11	9	66	36	5
SEB5MA	M5"	8	5,5	3,5	17	7	100

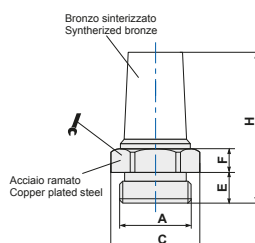

ART. SET

Silenziatore con testa esagonale
Hex head silencer

CODICE	A	E	F	L	H		
SET18	1/8" BSP	11,5	4,5	13	17,5	8	100
SET14	1/4" BSP	15	6	18	24	10	50
SET38	3/8" BSP	19	7	24	31	13	25
SET12	1/2" BSP	23	8	29	37	14	25
SET34	3/4" BSP	30	9	41	50	19	5
SET01	1" BSP	37	11	51	62	24	5
SET5MA	M5"	8,5	5	15	20	27	100

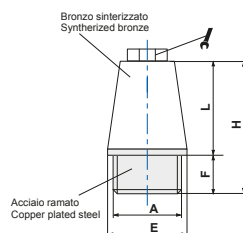

ART. SCQ

Silenziatore con testa quadra
Square head silencer

CODICE	A	E	F	L	H		
SCQ18	1/8" BSP	12	6	15	21	7	100
SCQ14	1/4" BSP	15	6	19	25	9	50
SCQ38	3/8" BSP	19	8	28	38	10	25
SCQ12	1/2" BSP	23	10	33	43	14	25
SCQ34	3/4" BSP	29	13	40	53	17	5
SCQ01	1" BSP	36	15	48	63	23	5

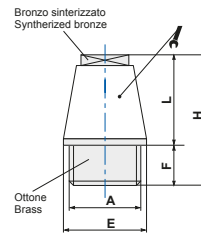

ART. SFT

Silenziatore a cupola su base circolare
Dome silencer on a circular base

CODICE	A	F	H	ØE	
SFT18	1/8" BSP	6	13	12	100
SFT14	1/4" BSP	7	14	16	50
SFT38	3/8" BSP	8	18	19	25
SFT12	1/2" BSP	10	19	23	25
SFT34	3/4" BSP	10	22	29	5
SFT01	1" BSP	12	23	36	5
SFT5MA	M5"	5	12	11	100

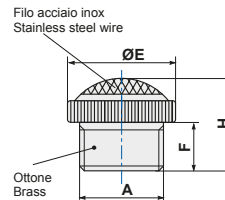

ART. STT

Silenziatore a tappo con taglio cacciavite
Cap silencer with screwdriver cut

CODICE	A	B	F	L	H	C	
STT18	1/8" BSP	10	6	6	12	1,5	100
STT14	1/4" BSP	13	6	6	12	1,5	50
STT38	3/8" BSP	17	7	8	15	1,5	25
STT12	1/2" BSP	21	10	8	18	1,5	25
STT34	3/4" BSP	26	13	9	22	1,5	5
STT01	1" BSP	33	14	11	25	1,5	5

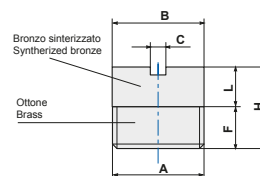

ART. SFE

Silenziatore a cupola su base esagonale
Dome silencer on hexagonal base

CODICE	A	F	H		
SFE18	1/8" BSP	6	15	13	100
SFE14	1/4" BSP	7	18	16	50
SFE38	3/8" BSP	8	20	19	50
SFE12	1/2" BSP	10	22	24	25
SFE34	3/4" BSP	10	26	30	25
SFE01	1" BSP	12	28	36	10
SFE5MA	M5"	4	8	8	100
SFE18FEM	1/8" FEM BSP	7	18	14	50

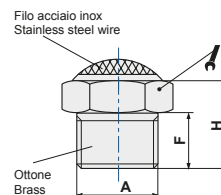

ART. SFEX

Silenziatore inox a cupola su base esagonale
Stainless steel dome silencer on hexagonal base

CODICE	A	F	H		
SFEX18	1/8" BSP	6	15	13	50
SFEX14	1/4" BSP	7	18	16	50
SFEX38	3/8" BSP	8	20	19	50
SFEX12	1/2" BSP	10	22	24	25
SFEX34	3/4" BSP	10	26	30	5
SFEX01	1" BSP	12	28	36	5

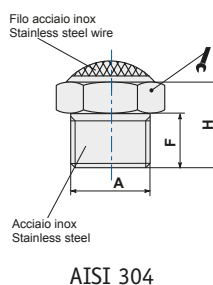

ART. SBP

Silenziatore piatto su base circolare
Flat silencer on circular base

CODICE	A	B	E	F	H	
SBP18	1/8" BSP	11	12	6	12	100
SBP14	1/4" BSP	14	16	7	13	50
SBP38	3/8" BSP	17	19	8	17	25
SBP12	1/2" BSP	22	23	10	18	25
SBP34	3/4" BSP	28	29	10	20	5
SBP01	1" BSP	35	36	12	21	5
SBP5MA	M5"	11	12	5	11,5	100

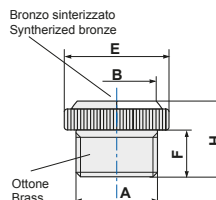

ART. SEP

Silenziatore piatto su base esagonale
Flat silencer on hexagonal base

CODICE	A	B	F	H		
SEP18	1/8" BSP	11	6	14	13	100
SEP14	1/4" BSP	14	7	17	16	50
SEP38	3/8" BSP	17	8	18	19	25
SEP12	1/2" BSP	22	10	20	24	25
SEP34	3/4" BSP	28	10	23	30	5
SEP01	1" BSP	35	12	25	36	5
SEP5MA	M5"	7	5	12	8	100
SEP18FEM	1/8" FEM BSP	11	7	17	14	50

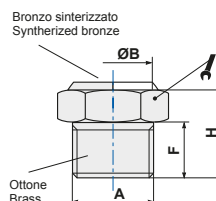

ART. SP

Silenziatore piatto a scomparsa
Retractable flat silencer

CODICE	A	B	H	
SP18	1/8" BSP	6	5	100
SP14	1/4" BSP	8	6	50
SP38	3/8" BSP	10	7	25
SP12	1/2" BSP	15	8	25
SP34	3/4" BSP	20	9	5
SP01	1" BSP	26	10	5

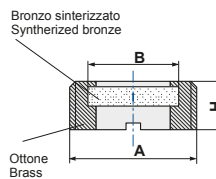

ART. SPL-P

Silenziatore in polietilene con base filettata
Polyethylene silencer with threaded base

CODICE	A	D	H	h	
SPLP-M5	M5	6,5	21,5	4,0	50
SPLP-18	1/8	12,5	34,0	5,5	50
SPLP-14	1/4	15,5	42,5	8,0	50
SPLP-38	3/8	18,5	67,5	11,5	50
SPLP-12	1/2	23,5	77,5	11,0	50
SPLP-34	3/4	38,5	131,5	16,0	50
SPLP-1	1"	49,0	161,0	21,0	50

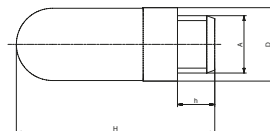

ART. SPL-R

Silenziatore in polietilene con base a codolo
Polyethylene silencer with plug base

CODICE	A	D	H	h	
SPLR-04	4,0	7,0	32,0	16,0	50
SPLR-06	6,0	12,5	45,0	20,5	50
SPLR-08	8,0	13,5	43,5	21,5	50
SPLR-10	10,0	15,5	57,5	26,5	50
SPLR-12	12,0	18,5	82,0	29,0	50

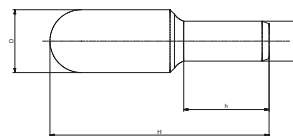

INFORMAZIONI TECNICHE AGGIUNTIVE

Tutti silenziatori per aria compressa illustrati nel catalogo sono stati classificati in base a riscontri oggettivi avuti a seguito di prove di flusso e prove di rumore a cui sono stati sottoposti dal costruttore. Le prove di portata sono state eseguite variando la pressione a monte tramite il regolatore di pressione. Le prove di rumore sono state eseguite in ambiente di lavoro a due livelli di pressione: 6 bar e a 4 bar.

A titolo esemplificativo riportiamo di seguito il diagramma di portata relativo al modello SFE18 e una tabella riepilogativa dei livelli di rumore rilevati alla pressione di 6 bar sui modelli a maggiore movimentazione (considerare che a 4 bar tali valori si abbassano mediamente di un 3-6% circa in funzione del modello e della misura).

ADDITIONAL TECHNICAL INFORMATION

All silencers for air compressed illustrated ON the catalog have been classified according to objective evidence got as a result of flow tests and noise tests to which they were subjected by the manufacturer. The flow tests were carried out by varying the pressure upstream via the pressure regulator. The noise tests have been performed in the work environment at two pressure levels: 6 bar and 4 bar.

As an example is shown below the flow chart for the model SFE18 and a summary table of the levels of noise measured at a pressure of 6 bar on the main models (consider that at 4 bar such values fall on average values of about 3-6% depending on the model and size).

Modello	Livelli di rumore a 6 BAR (dB) Noise level at 6 BAR					
	1/8	1/4	3/8	1/2	3/4	1"
SBE	75	81	82	85		
SEB	79	78	82	85	94	95
SEP	73	74	85	89	89	90
SFE	74	72	88	90	90	92
SP	72	73	84	88	88	89
SVE	72	73	84	88	88	89
SPL	87	84	90	90	91	90
SPLF	87	90	92	92		

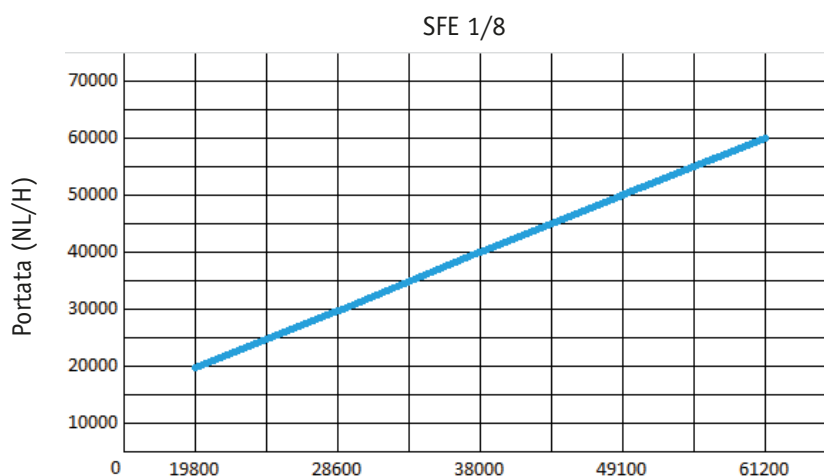

BREVE DESCRIZIONE

I silenziatori metallici in filo d'acciaio inox, bronzo, ottone, polvere di bronzo e acciaio inox sono prodotti in Italia in conformità alla normativa ISO 9002 e costituiscono la soluzione ad ogni tipo di esigenza, dalla depurazione di fluidi (liquidi e gassosi) all'assorbimento dei rumori e degli urti di liquidi e gas.

SHORT DESCRIPTION

The silencers metal wire stainless steel, bronze, brass, bronze powder and stainless steel are produced in Italy in accordance with ISO 9002 and are the solution to every need, from the purification of fluids (liquids and gases) to shock and noise absorption of liquids and gases.

SCHEDA TECNICA *TECHNICAL SHEET*

FLUIDI UTILIZZABILI <i>EMPLOYABLE FLUIDS</i>	Fluidi liquidi e gassosi, aria compressa (per specifiche contattare il nostro UT) <i>Liquids and gases, compressed air (for information contact our UT)</i>	
APPLICAZIONI <i>APPLICATIONS</i>	Apparecchiature pneumatiche, sistemi di filtraggio, riduzione, abbattimento e protezione connessi all'uso di fluidi. <i>Pneumatic equipment, filtration systems, reduction, abatement and protection related to the use of fluids.</i>	
TUBI CONSIGLIATI <i>SUGGESTED TUBES</i>	Normalmente non applicati direttamente a tubi, comunque presenti negli impianti e definiti in funzione delle applicazioni. <i>Normally not applied directly to pipes, however defined according to the applications.</i>	
TEMPERATURE E PRESSIONI <i>TEMPERATURE AND PRESSURE</i>	Nelle applicazioni pneumatiche si uniformano ai requisiti degli altri componenti, quali la raccorderia, l'elemento saliente, il livello di rumore massimo, viene determinato a 4 e a 6 bar. <i>In pneumatic applications they follow the requirements of other similar components, such as fittings, the salient element, the maximum noise level, is anyway determined at 4 and 6 bar.</i>	
FILETTATURE <i>THREAD TYPE</i>	BSP gas cilindrica non nichelata (nichelato di serie solo nel modello SC). <i>BSP pipe thread no nickel (standard nickel-plated on SC model only).</i>	
MATERIALI <i>MATERIALS</i>	corpi <i>bodies</i>	Ottone, acciaio inox, acciaio ramato, resina acetica e nylon (corpi). <i>Brass, stainless steel, copper-plated steel, acetal resin and nylon.</i>
	filo <i>seals</i>	acciaio inox. <i>stainless steel.</i>
	filtri <i>filters</i>	bronzo sinterizzato. <i>sintered bronze.</i>

ART. 83892600

 Ugello rotondo a più canali ABS
Circular multi-channel nozzle ABS
Pezzo di precisione stampato in plastica antiurto POM.

In questo modello sono incorporati tutti i pregi dell'ugello piatto, in più ne amplia il campo d'impiego ed è pure idoneo per un impiego fisso.

Note: la forza soffiante è stata misurata a 50 mm dall'uscita e i valori sulla rumorosità sono dentro i parametri DIN 45645.

Nel montaggio di questo ugello a più canali, deve essere sfruttata tutta la lunghezza del pezzo filettato.

Dimensioni:

55 x 23 x 10

(lunghezza x diametro est. x lunghezza filettatura)

Raccordo del tubo:

R1/4" (filettatura esterna all'imbocco)

Caratteristiche:

antiurto sino a -40°C

indeformabile sino a +90°C

resistente a combustibili, oli minerali, lubrificanti e ogni tipo di solvente.

Cod. 838.926

Circular multi-channel nozzle POM.

Material: impact-resistant plastic

This model combines the undisputed advantages of the flat jet nozzle with a broader range of application and is ideal for stationary tasks.

Note: the blowing force was measured 50 mm in front of the nozzle. The sound levels were measured in compliance with DIN 45635.

When installing the multi-channel nozzles, the full thread length should be used.

Dimensions:

55 x 23 x 10

(L x ext. diam. x thread length)

Pipe connection:

R 1/4" (external thread on air inlet)

Characteristics:

Impact-resistant down to -40°C

Dimensional stability up to +90°C

Resistant to fuels, mineral oils, lubricants and commonly used solvents.

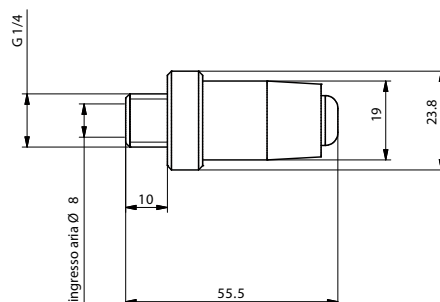

ART. 923702

 Ugello rotondo a più canali AL
Circular multi-channel nozzle AL
Pezzo di precisione stampato in alluminio.

Raccomandato in particolari condizioni d'impiego es. fonderia.

Campo d'impiego principale: pistole ad aria.

Note: la forza soffiante è stata misurata a 50 mm dall'uscita e i valori sulla rumorosità sono dentro i parametri DIN 45645.

Dimensioni:

31,5 x 18,5 x 8 (lunghezza x diametro est. x lunghezza filettatura)

Raccordo per tubo:

R1/4" (filettatura esterna all'imbocco)

Codice: 923.702

Material: aluminium.

Recommended for particularly harsh operating conditions, such as high temperatures (foundries, etc.) Principle application: blow guns.

Note: the blowing force was measured 50 mm in front of the nozzle. The sound levels were measured in compliance with DIN 45635.

Dimensions:

31.5 x 18.5 x 8 (L x ext. diam. x thread length)

Pipe connection:

R 1/4" (external thread on air inlet)

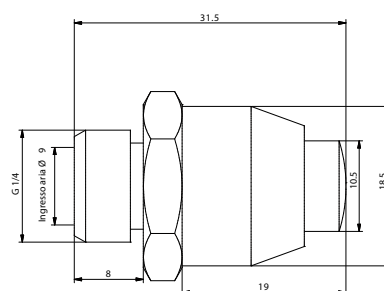

ART. 06952300T

Ugello piatto a più canali
Multi-channel flat jet nozzle

Dimensioni:

90 x 47 x 14.5

(lunghezza x larghezza x altezza)

Tubo di raccordo:

R1/4" (filettatura esterna sul tubo di entrata)

Caratteristiche:

Antiurto sino a -40° C

Indeformabile sino a +90°C

Resistente a combustibili, oli minerali o solventi di ogni tipo.

Fornibile come:

Ugello piatto a più canali.

La forza soffiante mirata.

La disposizione parallela dei getti d'aria, permette di avere un ampio raggio di soffiatura nei pezzi trasportati.

Anche pezzi di piccole dimensioni lavorati su torni automatici, possono venire investiti da un getto d'aria ben preciso.

La nuova forma ne permette la totale intercambiabilità con i modelli presenti sul mercato e garantisce un aumento della linea di soffiature.

Dimensions:

90 x 47 x 14,5 (LxWxH)

Pipe connection:

R 1/4 " (external thread on air inlet)

Characteristics:

Impact-resistant down to -40°C

Dimensional stability up to +90°C

Resistant to fuels, mineral oils, lubricants and commonly used solvents

Form of delivery:

Multi-channel flat jet nozzle

Concentrated blowing power.

The parallel arrangement of the component air streams gives an optimum blow-out width for work piece conveyance.

Even the smallest finished parts, e.g. on lathes, can be accurately and efficiently blown out.

The new design enables the interchangeability with the main models available on the market and grant a larger blow-out line.

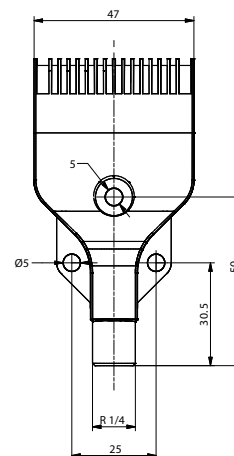

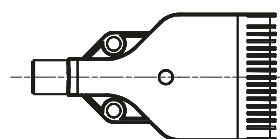
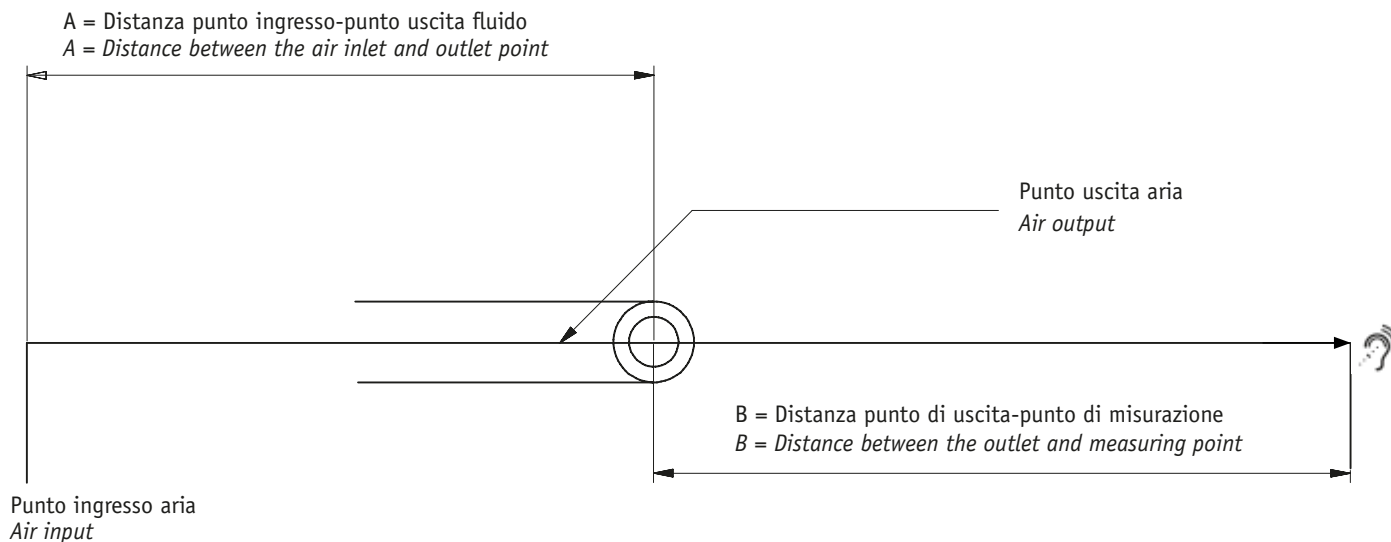
Test livello sonoro • Noise level test

Ugello Piatto a più canali <i>Multi channels flat nozzle</i>	
Pressione ingresso (Bar) <i>Input pressure (Bar)</i>	Picco Massimo (dB) <i>Max peak (dB)</i>
2	61
4	66
6	71
8	75

A = 270 mm
 B = 400 mm

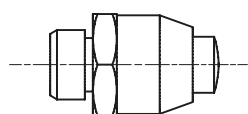

Ugello tondo in alluminio <i>Aluminium round nozzle</i>	
Pressione ingresso (Bar) <i>Input pressure (Bar)</i>	Picco Massimo (dB) <i>Max peak (dB)</i>
2	65
4	69
6	75
8	79

A = 200 mm
 B = 400 mm

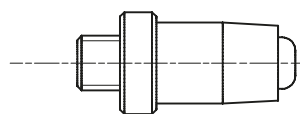

Ugello tondo in plastica <i>Plastic round nozzle</i>	
Pressione ingresso (Bar) <i>Input pressure (Bar)</i>	Picco Massimo (dB) <i>Max peak (dB)</i>
2	65
4	69
6	75
8	79

A = 240 mm
 B = 400 mm

BREVE DESCRIZIONE

Gli ugelli soffianti a pettine (Titan-Jet) e rotondi (in alluminio e tecnopolimero) sono realizzati in Italia, a garanzia di elevati standard di qualità, secondo le normative ISO di riferimento, e rispondono alle seguenti specifiche tecniche e applicative.

SHORT DESCRIPTION

The multi-channels flow nozzles, flat (Titan-Jet) and circular (in aluminium and plastic), are produced in Italy according to the reference ISO norms as warranty of high quality level and answer to the followings technical specifications and applications.

SCHEDA TECNICA TECHNICAL SHEET

FLUIDI UTILIZZABILI <i>EMPLOYABLE FLUIDS</i>	Fluidi liquidi e gassosi, aria compressa (per specifiche contattare il nostro UT) <i>Liquids and gases, compressed air (for information contact our UT)</i>
APPLICAZIONI <i>APPLICATIONS</i>	Sistemi di pulizia e raffreddamento fluido, abbattimento rumore, impieghi come cortine d'aria. Linee di irrigazione <i>Fluid methods for cleaning and cooling fluid, noise abatement, uses as air curtains, irrigation systems</i>
TUBI DI COLLEGAMENTO <i>CONNECTING TUBES</i>	Normalmente non applicati direttamente a tubi, comunque presenti negli impianti e definiti in funzione delle applicazioni <i>Normally not applied directly to pipes, however defined according to the applications</i>
TEMPERATURE E PRESSIONI <i>TEMPERATURE AND PRESSURE</i>	Nelle applicazioni pneumatiche si uniformano ai requisiti degli altri componenti, stesso materiale, quali la raccorderia. Nelle versioni in POM l'indefornabilità è garantita fino a +90°C mentre la resistenza agli urti fino a -40°C <i>In pneumatic applications they follow the requirements of other same materials components, such as fittings. In the POM versions indeformability is guaranteed up to + 90 °C, while the impact resistance down to -40 °C.</i>
FILETTATURE <i>THREAD TYPE</i>	BSPP 1/4 gas cilindrica <i>BSPP 1/4 gas parallel</i>
MATERIALI <i>MATERIALS</i>	ABS-GP40 norme ASTM/IEC/UL (modello piatto) POM antiurto (modello rotondo) Alluminio (modello rotondo AL) <i>ABS-GP40 norms ASTM/IEC/UL (flat model)</i> <i>POM shockproof (round model)</i> <i>Aluminium (round model AL)</i>



FIGURA 1

FIGURA 2

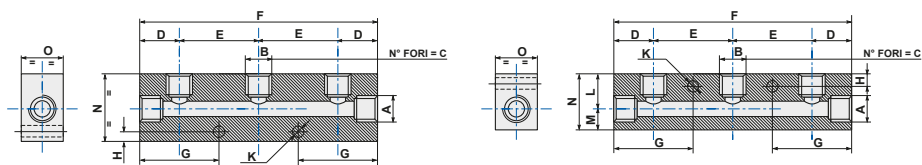

FIGURA 3

ART. RIPUL

 Ripartitori con uscite lineari
In-line output manifolds

CODICE	FIG.	A	B	C	D	E	F	G	H	K	L	M	N	O	FILETTATURA / THREAD	
RIPUL1512	3	1/4"	1/8"	2	15	30	60	30	4,5	5,25			30	20	4 VIE 2-1/4" 2-1/8"	5
RIPUL1513	1	1/4"	1/8"	3	15	30	90	30	4,5	5,25			30	20	5 VIE 2-1/4" 3-1/8"	5
RIPUL1514	1	1/4"	1/8"	4	15	30	120	30	4,5	5,25			30	20	6 VIE 2-1/4" 4-1/8"	5
RIPUL1515	1	1/4"	1/8"	5	15	30	150	30	4,5	5,25			30	20	7 VIE 2-1/4" 5-1/8"	5
RIPUL1516	1	1/4"	1/8"	6	15	30	180	30	4,5	5,25			30	20	8 VIE 2-1/4" 6-1/8"	5
RIPUL1522	3	3/8"	1/4"	4	18	36	72	36	6	6,5			40	20	4 VIE 2-3/8" 2-1/4"	5
RIPUL1523	2	3/8"	1/4"	3	18	36	108	36	6	6,5	19	11	30	20	5 VIE 2-3/8" 3-1/4"	5
RIPUL1524	2	3/8"	1/4"	4	18	36	144	36	6	4,5	19	11	30	20	6 VIE 2-3/8" 4-1/4"	5
RIPUL1525	2	3/8"	1/4"	5	18	36	180	36	6	6,5	19	11	30	20	7 VIE 2-3/8" 5-1/4"	5
RIPUL1526	2	3/8"	1/4"	6	18	36	216	36	6	6,5	19	11	30	20	8 VIE 2-3/8" 6-1/4"	5
RIPUL1542	3	1/2"	1/4"	2	22	36	80	40	6	6,5			40	28	4 VIE 2-1/2" 2-1/4"	5
RIPUL1543	1	1/2"	1/4"	3	22	36	116	40	6	6,5			40	28	5 VIE 2-1/2" 3-1/4"	5
RIPUL1544	1	1/2"	1/4"	4	22	36	152	40	6	6,5			40	28	6 VIE 2-1/2" 4-1/4"	5
RIPUL1545	1	1/2"	1/4"	5	22	36	188	40	6	6,5			40	28	7 VIE 2-1/2" 5-1/4"	5
RIPUL1546	1	1/2"	1/4"	6	22	36	224	40	6	6,5			40	28	8 VIE 2-1/2" 6-1/4"	5
RIPUL1552	3	1/2"	3/8"	2	22	36	80	40	6	6,5			40	28	4 VIE 2-1/2" 2-3/8"	5
RIPUL1553	1	1/2"	3/8"	3	22	36	116	40	6	6,5			40	28	5 VIE 2-1/2" 3-3/8"	5
RIPUL1554	1	1/2"	3/8"	4	22	36	152	40	6	6,5			40	28	6 VIE 2-1/2" 4-3/8"	5
RIPUL1555	1	1/2"	3/8"	5	22	36	188	40	6	6,5			40	28	7 VIE 2-1/2" 5-3/8"	5
RIPUL1556	1	1/2"	3/8"	6	22	36	224	40	6	6,5			40	28	8 VIE 2-1/2" 6-3/8"	5

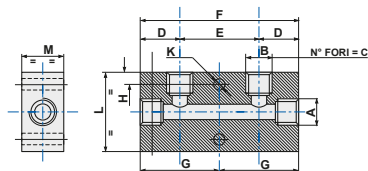
ART. RIP4V

Ripartitore a 4 vie
Aluminium cross manifold

CODICE	A	B	C	D	E	
RIP4V1815	1/8"	17	25	15	4,5	25
RIP4V1816	1/8"	23	30	16	4,5	25
RIP4V1418	1/4"	23	30	18	4,5	25
RIP4V1420	1/4"	26	40	20	5,5	25
RIP4V3820	3/8"	30	40	20	5,5	10
RIP4V3825	3/8"	33	50	25	5,5	10
RIP4V1230	1/2"	33	50	30	5,5	10

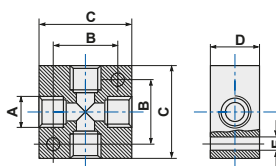

ART. RIPUC

Ripartitori con uscite contrapposte
Opposite output manifolds

CODICE	FIG.	A	B	C	D	E	F	G	H	K	L	M	FILETTATURA THREAD	
RIPUC15122	1	1/4"	1/8"	4	15	30	60	30	4,5	5,25	30	20	6 VIE 2-1/4" 4-1/8"	5
RIPUC15133	2	1/4"	1/8"	6	15	30	90	30	4,5	5,25	30	20	8 VIE 2 1/4" 6-1/8"	5
RIPUC15144	2	1/4"	1/8"	8	15	30	120	30	4,5	5,25	30	20	10 VIE 2-1/4" 8-1/8"	5
RIPUC15155	2	1/4"	1/8"	10	15	30	150	30	4,5	5,25	30	20	12 VIE 2-1/4" 10-1/8"	5
RIPUC15222	1	3/8"	1/4"	4	18	36	72	36	6	6,5	40	20	6 VIE 2-3/8" 4-1/4"	5
RIPUC15233	2	3/8"	1/4"	6	18	36	108	36	6	6,5	40	20	8 VIE 2-3/8" 6-1/4"	5
RIPUC15244	2	3/8"	1/4"	8	18	36	144	36	6	6,5	40	20	10 VIE 2-3/8" 8-1/4"	5
RIPUC15255	2	3/8"	1/4"	10	18	36	180	36	6	6,5	40	20	12 VIE 2-3/8" 10-1/4"	5
RIPUC15422	1	1/2"	1/4"	4	22	36	80	40	6	6,5	40	28	6 VIE 2-1/2" 4-1/4"	5
RIPUC15433	2	1/2"	1/4"	6	22	36	116	40	6	6,5	40	28	8 VIE 2-1/2" 6-1/4"	5
RIPUC15444	2	1/2"	1/4"	8	22	36	152	40	6	6,5	40	28	10 VIE 2-1/2" 8-1/4"	5
RIPUC15455	2	1/2"	1/4"	10	22	36	188	40	6	6,5	40	28	12 VIE 2-1/2" 10-1/4"	5
RIPUC15522	1	1/2"	3/8"	4	22	36	80	40	6	6,5	40	28	6 VIE 2-1/2" 4-3/8"	5
RIPUC15533	2	1/2"	3/8"	6	22	36	116	40	6	6,5	40	28	8 VIE 2-1/2" 6-3/8"	5
RIPUC15544	2	1/2"	3/8"	8	22	36	152	40	6	6,5	40	28	10 VIE 2-1/2" 8-3/8"	5
RIPUC15555	2	1/2"	3/8"	10	22	36	188	40	6	6,5	40	28	12 VIE 2-1/2" 10-3/8"	5



FIGURA 1



FIGURA 2

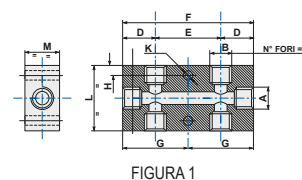

BREVE DESCRIZIONE

I ripartitori in alluminio si inseriscono nella circuiteria pneumatica come elemento compatto e modulare per la distribuzione dell'aria compressa.

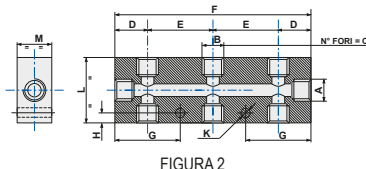
SHORT DESCRIPTION

The aluminum manifolds are inserted in the pneumatic circuitry as a compact and modular element for the distribution of compressed air.

SCHEDA TECNICA TECHNICAL SHEET

FLUIDI UTILIZZABILI <i>EMPLOYABLE FLUIDS</i>		Aria compressa (per altri fluidi contattare il nostro Ufficio Tecnico) <i>Compressed air (for different fluid pls contact our Technical Dept.)</i>
APPLICAZIONI <i>APPLICATIONS</i>		Le temperature sono comprese nell'intervallo dell'ambiente di lavoro (da -20°C a +130°C), la pressione massima di esercizio é <12 bar. <i>The temperatures are within the range of the working environment (from -20 ° C to + 130 ° C), the maximum operating pressure is <12 bar.</i>
CARATTERISTICHE TECNICHE <i>TECHNICAL FEATURES</i>	TEMPERATURE E PRESSIONI <i>TEMPERATURE AND PRESSURE</i>	Le temperature sono comprese nell'intervallo dell'ambiente di lavoro (da -20°C a +100°C), la pressione massima di esercizio é <12 bar. <i>The temperatures are within the range of the working environment (from -20° C to + 100° C), the maximum operating pressure is <12 bar.</i>
	FILETTATURE <i>THREAD TYPE</i>	BSP cilindrica ISO 228 <i>BSP parallel UNI-ISO 228</i>
	MATERIALE <i>MATERIAL</i>	Lega EN-AW-6005-T6 estrusa secondo normativa UNI EN 755-2:2016 <i>EN-AW-6005-T6 alloy extruded according to UNI EN 755-2: 2016</i>
CARATTERISTICHE MECCANICHE <i>MECHANICAL FEATURES</i>	Rm (Carico di rottura minimo) <i>Rm (Minimum breaking load)</i>	255 Mpa
	Rp 0,2 (Tensione di snervamento) <i>Rp 0,2 (yield strenght)</i>	215 Mpa
	Allungamento % minimo <i>Minimum elongation %</i>	8mm
	Durezza tipica <i>Typical hardness</i>	85 HBW (brinell)
	1 Mpa	=10,1972 Kg/cm2
NOTA <i>NOTE</i>	Questi valori, indicati nella norma 755-2, si intendono per profilo soggetto a trazione meccanica, non ad un carico applicato diversamente (laterale, in punta). <i>These values, indicated in the 755-2 standard, refer to a profile subject to mechanical traction, not to a differently applied load (lateral, at the tip).</i>	



VALVOLE E RUBINETTI

ART. 503

 Valvola scarico rapido in ottone
Brass quick exhaust valve

CODICE	A	B	L1	L2			
50318	G1/8	8	42	28		14	25
50314	G1/4	11	53,3	34,5		19	10
50338	G3/8	12	58	36		21	10
50312	G1/2	14	71	44		26	10
50334	G3/4	18	86	52		32	2
50301	G1"	19	94	56		38	1
50314P	G1/4	11	53,3	34,5		19	10

P: Tecnopolimero

ART. JXQ

 Valvola di scarico rapido "Heavy Duty"
"Heavy Duty" quick exhaust valve

CODICE	T	H	L			
JXQ2000-06	3/4	112	92			1
JXQ2500-10	1"	112	92			1

Di importazione
Imported

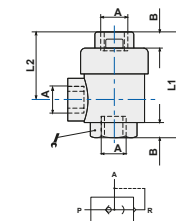
ART. UR

 Pastiglia per valvola di scarico
Tablet for exhaust valve

CODICE	-	A	B	Materiale
UR05	M5	13,5	4,5	NBR
UR08	1/8	20,5	5	PU
UR17	1/4 - 3/8	25,5	5,8	PU
UR35	1/2	35,5	8,2	PU
UR44	3/4 - 1"	40,5	9	PU

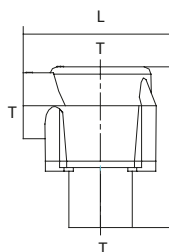
ART. JAQ

 Valvola di scarico rapido "Cube"
"Cube" quick exhaust valve

CODICE	T	Mx	L	H		
JAQ2000-01	1/8	45	45	40		1
JAQ2000-02	1/4	45	45	40		1
JAQ3000-02	1/4	56	56	50		1
JAQ3000-03	3/8	56	56	50		1
JAQ5000-04	1/2	85	85	75		1
JAQ5000-06	3/4	85	85	75		1

Di importazione
Imported

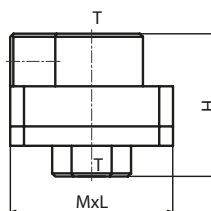

CARATTERISTICHE TECNICHE VALVOLE SCARICO RAPIDO SERIE 503/503P

Condizioni generali di prova e prova di durata:
 Fluido: Aria filtrata
 Temperatura: 20 ° C
 Pressione: 6 bar
 Capacità serbatoio: 5 litri

Risultati della prova

Le valvole in tecnopolimero hanno la stessa portata della versione in ottone, anche il tempo di pressurizzazione e di svuotamento del serbatoio è il medesimo.

Il tempo di apertura e di scarico delle valvole non cambia variando la temperatura di esercizio, da -20 °C a +50°C.

La forza di strappo dei filetti per il tecnopolimero è inversamente proporzionale all'aumento della temperatura.

Sottoponendo le valvole ad un ciclo continuo di 50000 carichi/scarichi, alla pressione costante di 7 bar, il comportamento non ha evidenziato irregolarità.

TEST SCARICO RAPIDO - VOLUME 5 LITRI

Versione in ottone - Brass version

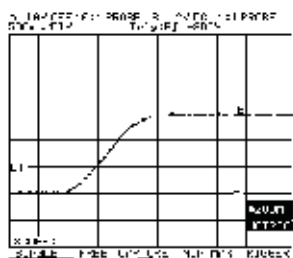

tempo carica 1,5 secondi - load time 1,5 seconds

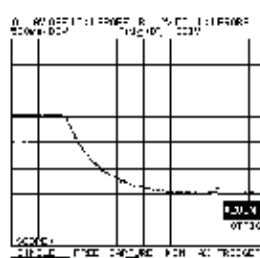

tempo carica 2 secondi - load time 2 seconds

ADDITIONAL TECHNICAL FEATURES QUICK EXHAUST VALVES 503/503P SERIES

General test conditions and life test:
 Fluid: Filtered air
 Temperature: 20 ° C
 Pressure: 6 bar
 Tank capacity: 5 liters

Test Results

The technopolymer valves have the same flow rate as the brass version, the time of pressurization and emptying of the tank is the same.

The opening and the exhaust time of the valves do not change by varying the operating temperature, from -20 ° C to +50 ° C.

The breakout of the threads, for the technopolymer version, is inversely proportional to the temperature rise.

Subjecting the valves to 50,000 charge/discharge continuous cycles, at a constant pressure of 7 bar, the functioning was showing none irregularities.

QUICK EXHAUST TEST - VOLUME 5 LITERS

Versione in tecnopolimero - Technopolymer version

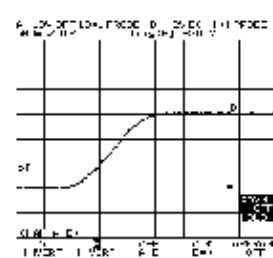

tempo carica 1,5 secondi - load time 1,5 seconds

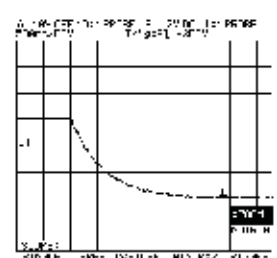

tempo carica 2 secondi - load time 2 seconds

Valvola Valve		Portata (l/min) Flow rate (l/min)	
		PA	AR
50314 ottone brass	6 bar p=1	1070	1590
	6 bar max	2050	2360
503P14 tecnopolimero technopolymer	6 bar p=1	1130	1590
	max	2170	2350

RESISTENZA FILETTI (tecnopolimero) THREADS RESISTANCE (technopolymer)		
Temperatura (°C) Temperature (°C)	Forza di rottura (Kgf) Breaking load (Kgf)	Coppia di strappo (Nm) Breakout torque (Nm)
+20°C	525	5,0
+50°C	465	4,2
-20°C	640	5,5

BREVE DESCRIZIONE

Le valvole di scarico rapido serie 503, sono realizzate in Italia, a garanzia di elevati standard di qualità, secondo le normative ISO di riferimento, e rispondono alle seguenti specifiche tecniche e applicative.

SHORT DESCRIPTION



The quick exhaust valves and the manually valves, 503 series, are produced in Italy according to the reference ISO norms as warranty of high quality level and answer to the followings technical specifications and applications.

SCHEDA TECNICA TECHNICAL SHEET

FLUIDI UTILIZZABILI <i>EMPLOYABLE FLUIDS</i>	Aria compressa (per altri fluidi contattare il nostro Uff. Tecnico) <i>Compressed air (for different fluid pls contact our Technical Dept.)</i>
APPLICAZIONI <i>APPLICATIONS</i>	Circuiti pneumatici <i>Pneumatic systems (503 Series)</i>
TEMPERATURE E PRESSIONI <i>TEMPERATURE AND PRESSURE</i>	Temperatura di esercizio da -20° a +50° °C Pressione di esercizio da 0,30 a 10 bar <i>Working temperature from -20° to +50° °C Working pressure from 0,30 to 10 bar</i>
FILETTATURE <i>THREAD TYPE</i>	BSPP gas cilindrica ISO 228 <i>BSP cilindrica UNI-ISO 228</i>
MATERIALI <i>MATERIALS</i>	Ottone UNI EN 12165 CW617N (corpo, tappo) POM copolimero ISO1043-1 (corpo, tappo versione "503P") Elastomero poliuretano (elemento di tenuta) <i>Brass UNI EN 12165 CW617N (body, plug) POM copolymer ISO1043-1 (body, plug "503P" version) Polyurethane elastomer (sealing element)</i>

ART. 504

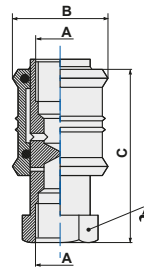

Valvola a corsoio manuale in alluminio
Hand slide valve

CODICE	A	B	C		
50418	G1/8	25	40	14	10
50414	G1/4	30	46	17	10
50438	G3/8	35	52	21	10
50412	G1/2	40	62	26	10



ART. 505

Valvola a corsoio manuale in ottone
Hand slide valve

CODICE	A	B	C		
505M5	M5	14	30,5	10	10
50518	G1/8	25	48	14	10
50514	G1/4	30	58	19	10
50538	G3/8	35	70	22	10
50512	G1/2	40	75	27	10
50534	G3/4	50	83	32	10

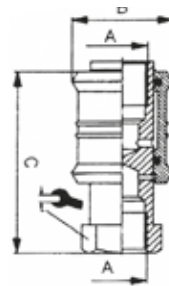

BREVE DESCRIZIONE

Le valvole manuali serie 504-505, sono realizzate in Italia, a garanzia di elevati standard di qualità, secondo le normative ISO di riferimento, e rispondono alle seguenti specifiche tecniche e applicative.

SHORT DESCRIPTION

The manually valves, 504-505 series, are produced in Italy according to the reference ISO norms as warranty of high quality level and answer to the followings technical specifications and applications.

SCHEDA TECNICA *TECHNICAL SHEET*

TUBI DI COLLEGAMENTO <i>CONNECTING TUBES</i>	Normalmente non applicate direttamente a tubi, comunque presenti negli impianti e definiti in funzione delle applicazioni <i>Normally not applied directly to pipes, however defined according to the applications</i>
TEMPERATURE E PRESSIONI <i>TEMPERATURE AND PRESSURE</i>	Temperatura di esercizio da -20° a +70° °C Pressione di esercizio max consigliata 10 bar <i>Working temperature from -20° to +70° °C Max suggested working pressure 10 bar</i>
FILETTATURE <i>THREAD TYPE</i>	BSPP gas cilindrica ISO 228 <i>BSP cilindrica UNI-ISO 228</i>
MATERIALI <i>MATERIALS</i>	Ottone UNI EN 12165 CW617N (corpo Serie 505) Alluminio anodizzato (corpo Serie 504, corpo Serie 504-505) NBR 70 DWGV-EN549 UL157 (guarnizione tenuta) <i>Brass UNI EN 12165 CW617N (body 505 Series) Anodized aluminum (body 504 Series, slider 504-505 Series) NBR 70 DWGV-EN549 UL157 (seals gasket)</i>

ART. VSTT

Valvola a sfera tubo/tubo
Tube/tube ball valve

CODICE	A	L	Ø TUBO	ØB	
VSTT0404	23	46	4	9	1
VSTT0606	23	50	6	11	1
VSTT0808	23	52	8	13	1

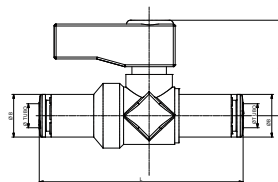

ART. 4010

Valvola a sfera maschio conico/femmina
Tapered male/female ball valve

CODICE	F	F1	P	I	I1	L	L1	H		
40100900	1/8	1/8	5,5	8	8	35,5	19	21,5	14	1
40101800	1/4	1/8	5,5	11	8	38	19	21,5	14	1
40101900	1/4	1/4	5,5	11	11	40,5	19	21,5	14	1
40102800	3/8	1/4	5,5	11,5	11	41,5	19	21,5	14	1
40102900	3/8	3/8	7	13	16	48	19	22,5	18	1
40103900	1/2	1/2	10	17	23	58	25	25	22	1

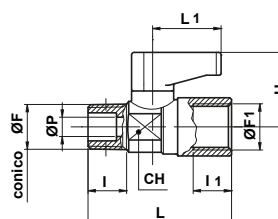

ART. 4000

Valvola a sfera femmina/femmina
Female/female ball valve

CODICE	F	F1	P	I	I1	L	L1	H		
40000900	1/8	1/8	5,5	8	8	36,5	19	21,5	14	1
40001900	1/4	1/4	5,5	11	11	11	19	21,5	14	1
40002900	3/8	3/8	7	11,5	16	48	19	22,5	18	1
40003900	1/2	1/2	10	16	23	59	25	32	32	1

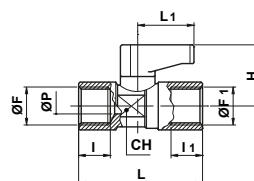

ART. 4020

Valvole a sfera maschio cilindrico/femmina
Parallel male/female ball valve

CODICE	F	F1	P	I	I1	L	L1	H		
40200900	1/8	1/8	5,5	7	8	34,5	19	21,5	14	1
40201800	1/4	1/8	5,5	8	8	35,5	19	21,5	14	1
40201900	1/4	1/4	5,5	8	11	37,5	19	21,5	14	1
40202800	3/8	1/4	5,5	5,5	9	11	19	21,5	14	1
40202900	3/8	3/8	7	10	16	43	19	22,5	18	1
40203900	1/2	1/2	10	15	23	58	25	32	22	1

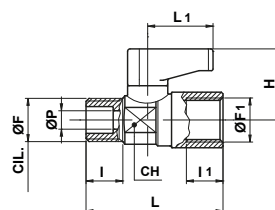

ART. 4030

 Valvola a sfera maschio conico/maschio cilindrico
Tapered/parallel male ball valve

CODICE	F	F1	P	I	I1	L	L1	H		
40300900	1/8	1/8	5,5	8	7	33	19	21,5	14	1
40301000	1/8	1/4	5,5	8	7,5	33,5	19	21,5	14	1
40301800	1/4	1/8	5,5	11	7	35,5	19	21,5	14	1
40301900	1/4	1/4	5,5	11	7,5	7,5	19	21,5	14	1
40302800	3/8	1/4	5,5	11,5	7,5	37	19	21,5	14	1
40302900	3/8	3/8	7	13	10	10	19	22,5	18	1
40303900	1/2	1/2	10	10	10	48	25	32	22	1

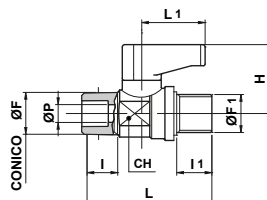
ART. 4050

 Valvola a sfera maschio conico attacco bicone
Tapered male ball valve bicone connection

CODICE	F	D	P	I	L	L1	H		
40501570	1/8	6	5,5	8	40,5	19	21,5	14	1
40501580	1/4	6	5,5	11	43,5	19	21,5	14	1
40501660	1/8	8	5,5	8	41,5	19	21,5	14	1
40501660	1/4	8	5,5	11	11	19	21,5	14	1
40501680	3/8	8	5,5	11,5	45	19	21,5	14	1

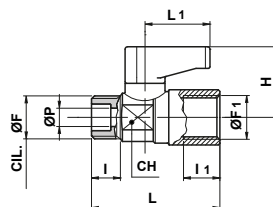
ART. 4070

 Valvola a sfera maschio cilindrico/femmina (serie corta)
Parallel male/female ball valve (short series)

CODICE	F	F1	P	I	I1	L	L1	H		
40700900	1/8	1/8	5,5	7	7	33,5	19	21,5	14	1
40701800	1/4	1/8	5,5	8	7	34,5	19	21,5	14	1
40701900	1/4	1/4	5,5	8	8	35	19	21,5	14	1
40702900	3/8	3/8	7	8	16	16	19	22,5	18	1
40703900	1/2	1/2	10	10	23	53	25	32	22	1

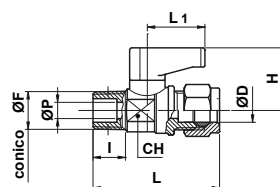
ART. 4080

 Valvola a sfera maschio cilindrico/maschio cilindrico
Parallel/parallel ball valve

CODICE	F	F1	P	I	I1	L	L1	H		
40800900	1/8	1/8	5,5	7	7	32	19	21,5	14	1
40801600	1/8	1/4	5,5	7	8	32,5	19	21,5	14	1
40801900	1/4	1/4	5,5	8	8	33,5	19	21,5	14	1
40802800	3/8	1/4	5,5	9	8	34,5	19	21,5	14	1
40802900	3/8	3/8	7	10	10	40	19	22,5	18	1
40803900	1/2	1/2	10	17	10	48	25	32	22	1

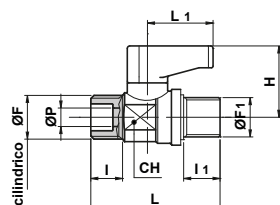

ART. 4100

Valvola a sfera maschio cilindrico attacco bicono
Parallel male ball valve bicone connection

CODICE	F	D	P	I	L	L1	H		
41001570	1/8	6	5,5	7	39,5	19	21,5	14	1
41001580	1/4	6	5,5	8	40,5	19	21,5	14	1
41001660	1/8	8	5,5	7	40,5	19	21,5	14	1
41001670	1/4	8	5,5	8	41,5	19	21,5	14	1
41001680	3/8	8	5,5	9	42,5	19	21,5	14	1

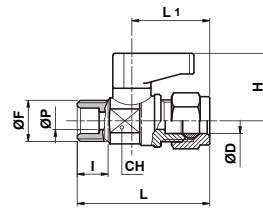

ART. 4110

Valvola a sfera bicono - bicono
Bicone - bicone ball valve

CODICE	D1	D	P	L	L1	H		
41105900	6	6	5,5	47	19	21,5	14	1
41106000	6	8	5,5	48	19	21,5	14	1
41106100	8	8	5,5	49	19	21,5	14	1

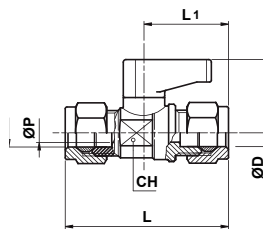

ART. 4120

Valvola a sfera maschio conico attacco a baionetta con ghiera
Tapered male ball valve bayonet connection with nut

CODICE	F	P	I	L	L1	H		
41201000	1/8	5,5	8	38,5	19	21,5	14	1
41201900	1/4	5,5	11	41	19	21,5	14	1

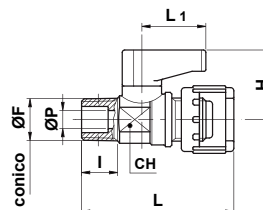

ART. 4160

Valvola a sfera maschio con attacco tubo automatico
Male ball valve with automatic tube connection

CODICE	D	F	P	I	L	L1	H		
41601490	4	1/8	5,5	8,5	41	19	21,5	14	1
41601500	4	1/4	5,5	11,5	44	19	21,5	14	1
41601570	6	1/8	5,5	8,5	41	19	21,5	14	1
41601580	6	1/4	5,5	11,5	44	19	21,5	14	1
41601590	6	3/8	5,5	12	45	19	21,5	14	1
41601670	8	1/4	5,5	11,5	48	19	21,5	14	1
41601680	8	3/8	5,5	12	48,5	19	21,5	14	1

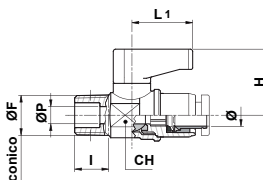

ART. 4190

Dado per valvola a sfera con bicono
Ball valve nut with bicone

CODICE	F	D	H		
41901570	1/8	6	11,5	12	1
41201900	1/4	8	12	15	1

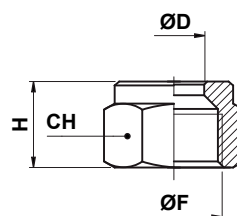

ART. 4200

Bicono in ottone per valvola a sfera
Brass bicone for ball valve

CODICE	D	H	
42007500	6	6,6	1
42008300	8	6,6	1

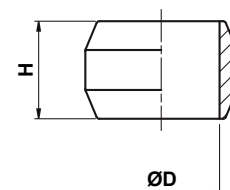

ART. 600

 Rubinetto sfera F.F. con leva
F.F. ball tap with lever

CODICE	G	G1	L1	L	P	L3	CH	
6001818	1/8	1/8	9	39	8	27,2	20	
6001414	1/4	1/4	9	39	8	27,2	20	
6003838	3/8	3/8	9,9	42	8	27,1	20	
6001212	1/2	1/2	11,7	47	10	29,4	24	
6003434	3/4	3/4	12	54	13,5	32	30	

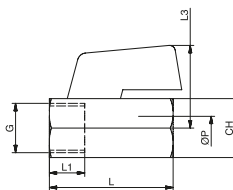
ART. 601

 Rubinetto sfera F.F. taglio cacciavite
F.F. screwdriver cut ball tap

CODICE	G	G1	I	L	P	h	CH	
6011818	1/8	1/8	9	39	8	13	20	
6011414	1/4	1/4	9	39	8	13	20	
6013838	3/8	3/8	9,9	42	8	13	20	
6011212	1/2	1/2	11,7	47	10	15,4	24	
6013434	3/4	3/4	12	54	13,5	18	30	

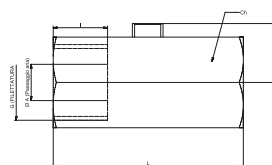
ART. 602

 Rubinetto sfera F.F. con leva lunga
Long lever F.F. ball tap

CODICE	G	G1	I	L	P	h	CH	
6021818	1/8	1/8	9	39	8	31,3	20	
6021414	1/4	1/4	9	39	8	31,3	20	
6023838	3/8	3/8	9,9	42	8	31,3	20	
6021212	1/2	1/2	11,7	47	10	33,8	24	
6023434	3/4	3/4	12	54	13,5	36,4	30	

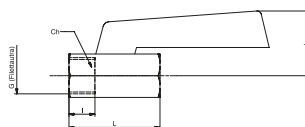
ART. 605

 Rubinetto sfera M.F. con leva
M.F. ball tap with lever

CODICE	G	G1	H	H1	L	h	CH	
6051818	1/8	1/8	9	10	39	27,2	20	
6051414	1/4	1/4	9,2	11	39	27,2	20	
6053838	3/8	3/8	10,2	9,8	40	27,2	20	
6051212	1/2	1/2	12,2	11,6	45	29,5	24	
6053434	3/4	3/4	14	12,2	51	32	30	

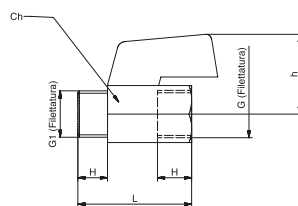

ART. 606

Rubinetto sfera M.F. taglio cacciavite
M.F. screwdriver cut ball tap

CODICE	G	G1	L1	L2	L	P	h	CH	
6061818	1/8	1/8	9	10	39	8	13	20	
6061414	1/4	1/4	9,2	11	39	8	13	20	
6063838	3/8	3/8	10,2	9,8	40	8	13	20	
6061212	1/2	1/2	12,2	11,6	45	10	15,4	24	
6063434	3/4	3/4	14	12,2	51	13,5	17,9	30	

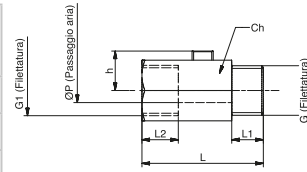

ART. 607

Rubinetto sfera M.F. con leva lunga
Long lever M.F. ball tap

CODICE	G	G1	H	H1	L	h	CH	
6071818	1/8	1/8	10	9	39	31,4	20	
6071414	1/4	1/4	11	9,2	39	31,4	20	
6073838	3/8	3/8	10	10,2	40	31,3	20	
6071212	1/2	1/2	11,6	12,2	45	33,8	24	
6073434	3/4	3/4	14	14	51	36	30	

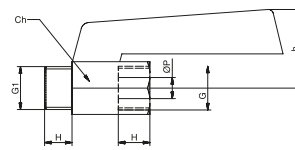

ART. 610

Rubinetto sfera M.M. con leva
M.M. ball tap with lever

CODICE	G	G1	L1	L	P	h	CH	
6101414	1/4	1/4	9	40,4	8	27,2	20	
6103838	3/8	3/8	10	42,4	8	27,4	20	
6101212	1/2	1/2	11,6	49,7	10	29,4	24	

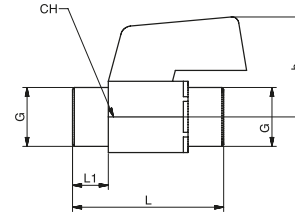

ART. 611

Rubinetto sfera M.M. taglio cacciavite
M.M. screwdriver cut ball tap

CODICE	G	G1	L1	L2	L	P	h	CH	
6111414	1/4	1/4	9	9	40,4	8	12,9	20	
6113838	3/8	3/8	10	10	42,4	8	12,9	20	
6111212	1/2	1/2	11,6	11,6	49,7	10	15,4	24	

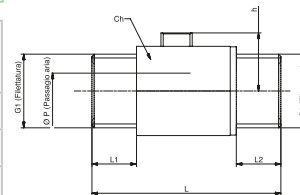

ART. 650

Rubinetto sfera F.F. con leva
F.F. ball tap with lever

MICRO

CODICE	G	G1	L1	L	P	L3	CH	
6501414	1/4	1/4	9	35	5,5	26,1	18	
6503838	3/8	3/8	7	38,5	8	27	20	
6501212	1/2	1/2	8,5	42	10	28,9	24	

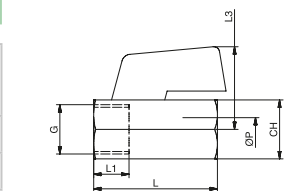

ART. 655

Rubinetto sfera M.F. con leva
M.F. ball tap with lever

MICRO

CODICE	G	G1	H	H1	L	P	h	CH	
6551414	1/4	1/4	9	7	35	5,5	26,1	18	
6553838	3/8	3/8	10	7	38,5	8	27	20	
6551212	1/2	1/2	9	9,3	32	10	28,9	24	

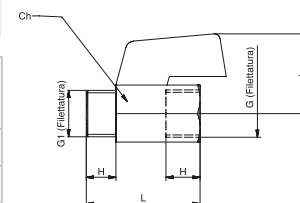

INFORMAZIONI TECNICHE AGGIUNTIVE “VSTT”

Ogni lotto dei rubinetti serie VSTT viene sottoposto a controlli cosiddetti “rompilotto” durante tutto il ciclo produttivo, che comprendono, oltre all’osservazione estetica, la verifica di funzionalità e di eventuali perdite, un test in pressione a 8 bar per verificarne la conformità anche in condizioni di utilizzo nominali. Successivamente viene eseguito un test a campione di rottura (simulazione scoppio a 50 bar di pressione) con una macchina dedicata che sollecita gli attacchi rapidi del rubinetto. Di seguito viene indicata la forza minima di strappo (in Newton) ammessa per ogni diametro:

Diam. tubo <i>Tube diam.</i>	Forza di strappo <i>Breaking load</i>
Ø4	63 N
Ø6	141 N
Ø8	251 N

Nota importante:

I valori indicati si riferiscono alla tenuta della pinza di aggraffaggio, “core part” come per il raccordo RAP in ottone e il Tecno-RAP in tecnopolimero, per cui omogenei. I valori di rottura sperimentali misurati sono stati, in base al diametro, anche da 1,2 a 2,5 volte superiori.

Informazioni complementari sulle temperature di utilizzo:

Pressione di esercizio e pressione di scoppio (bar) alle diverse temperature <i>Working pressure and breaking pressure (bar) at different temperatures</i>						
Esempio <i>Example</i>	T-20°C	T-20°C	T+23°C	T+23°C	T+60°C	T+60°C
Tubo 6x4 colorato <i>Tube 6x4 colored</i>	P esercizio bar <i>working P bar</i>	P scoppio bar <i>breaking P bar</i>	P esercizio bar <i>working P bar</i>	P scoppio bar <i>breaking P bar</i>	P esercizio bar <i>working P bar</i>	P scoppio bar <i>breaking P bar</i>
TPU	18,7	74,8	10,0	40,0	5,2	20,8
PA11	37,4	149,6	20,0	80,0	10,4	41,6
PA12	48,6	168,3	26,0	90,0	10,4	36,0
PE	18,7	74,8	10,0	40,0	5,0	20,0

Tutte le necessarie valutazioni sull’utilizzo dei rubinetti VSTT in condizioni di esercizio differenti da quelle suggerite nella scheda tecnica iniziale debbono anche tenere conto, con riferimento alle temperature, dei dati nominali relativi al tubo utilizzato e del limite imposto dal componente più critico. Le resine acetaliche, ad esempio, con cui sono realizzati alcuni particolari, e gli stessi o-ring, suggeriscono campi di utilizzo ben precisi. Specificatamente agli o-ring in NBR il fornitore dichiara una forbice compresa fra -25°C e +100°C.

“VSTT” ADDITIONAL TECHNICAL INFORMATION

Each VSTT taps series batch is tested according to severe cyclics “lot breaker” controls along all the production period, which include shape observation, leakage verification, functionality, at the working pressure of 8 bar.

Then all samples taken from the lot are tested by a traction machine which simulate a breaking pressure of 50 bar.

Here below are indicated the traction loads (in Newton) for each size:

Important note:

The values refer to the resistance of the crimping gripper, “core part” as per the two fittings series, the brass RAP and the technopolymer Tecno-RAP, whereby homogeneous. The breaking experimental values measured, according to the diameter, were from 1.2 to 2.5 times higher.

Additional information regarding the working temperatures:

Further to all the necessary assessments on the use of the VSTT taps in operating conditions different from how suggested in the initial technical sheet must be considered, with reference to temperatures, the nominal data regarding the type of the used tube and the limit imposed by the most critical component. Acetal resins with which some components are made, and the O-ring itself, suggest precise range of usage. Specifically to the NBR O-rings the supplier declares a fork between -25°C and +100°C.

BREVE DESCRIZIONE

I rubinetti a sfera con leva di regolazione, sono realizzati in Italia, a garanzia di elevati standard di qualità, secondo le normative ISO di riferimento, e rispondono alle seguenti specifiche tecniche e applicative.

SHORT DESCRIPTION

The mini ball valves with handle are produced in Italy according to the reference ISO norms as warranty of high quality level and answer to the followings technical specifications and applications.

SCHEDA TECNICA TECHNICAL SHEET

FLUIDI UTILIZZABILI <i>EMPLOYABLE FLUIDS</i>	Aria compressa (per altri fluidi contattare il nostro Uff. Tecnico) <i>Compressed air (for different fluid pls contact our Technical Dept.)</i>
APPLICAZIONI <i>APPLICATIONS</i>	Circuiti pneumatici, oleodinamici e idraulici <i>Pneumatic, oleodynamic and hydraulic circuits</i>
TUBI CONSIGLIATI <i>SUGGESTED TUBES</i>	Plastici: TPU, PA, PE, ecc. Metallici: rame, alluminio, acciaio <i>Plastic: TPU, PA, PE, etc. Metal: copper, aluminium, steel</i>
TEMPERATURE E PRESSIONI <i>TEMPERATURE AND PRESSURE</i>	Le temperature di utilizzo sono comprese fra -20°C e +80°C, la pressione massima consigliata è 20 bar. <i>Working temperature range -20°C to +80°C, max working pressure 20 bar</i>
FILETTATURE <i>THREAD TYPE</i>	BSPP gas cilindrica ISO 228 - BSPT gas conica ISO 7 - DIN 2999 <i>BSPP parallel UNI-ISO 228 - BSPT tapered UNI-ISO 7 - DIN 2999</i>
MATERIALI <i>MATERIALS</i>	Sfera, ogiva, dado, ghiera e alberino: ottone UNI EN 12164 CW614N (nichelato) Corpo: ottone UNI EN 12165 CW617N (nichelato) Leva: materiale plastico PA66 Vite: acciaio Guarnizione sede sfera: PTFE O-Ring: NBR 70 <i>Ball, olive, nut, ring nut and shaft: brass UNI EN 12164 CW614N (nickel plated)</i> <i>Body: brass UNI EN 12165 CW617N (nickel plated)</i> <i>Handle: PA66 plastic material</i> <i>Screw: steel</i> <i>Washer ball seat: PTFE</i> <i>O-Ring seal: NBR 70</i>

Direttiva 2011/65/UE (RoHS 2)

TITAN ENGINEERING SPA produce e commercializza raccordi e accessori per la pneumatica che potrebbero essere utilizzati come componenti/accessori in apparecchiature elettriche ed elettroniche, ove, in base alla Direttiva 2011/65/UE (RoHS 2) di cui all'Allegato II, è prescritto un contenuto di sostanze "con restrizione d'uso" inferiori ai valori di seguito riportati:

Piombo (0,1%) • Mercurio (0,1%) • Cadmio (0,01%) • Cromo esavalente (0,1%) • Bifenili polibromurati (PBB) (0,1%) • Eteri di bifenile polibromurato (PBDE) (0,1%) • Ftalato di BIS (2-etilesile) (DEHP) (0,1%) • Benzilbutifalato (BBP) (0,1%) • Dibutilftalato (DBP) (0,1%) • Disobutilftalato (DIBP) (0,1%)

In base alle dichiarazioni rilasciate dai nostri Fornitori, informiamo che i seguenti prodotti da noi fabbricati e commercializzati, illustrati nel presente catalogo:

- RACCORDI AUTOMATICI IN OTTONE
- RACCORDI AUTOMATICI IN TECNOPOLIMERO
- REGOLATORI DI FLUSSO IN OTTONE E TECNOPOLIMERO
- ASTINE IN OTTONE
- RACCORDI AUTOMATICI MINIATURIZZATI E INOX
- RACCORDI STANDARD DI LINEA IN OTTONE
- RACCORDI AD OGIVA IN OTTONE
- RACCORDI A CALZAMENTO IN OTTONE

fanno parte, in esenzione ai valori sopra dichiarati, dei prodotti in alluminio, acciaio e leghe di rame ed ottone, dell'Allegato III della direttiva stessa, che ne definisce espressamente tipologie e relativi limiti.

Regolamento CE 1907/2006 (REACH)

In base alle dichiarazioni rilasciate dai nostri Fornitori, TITAN ENGINEERING SPA dichiara di aver ottenuto:

- * relativa dichiarazione da cui risulta che i Fornitori stessi sono al corrente dei propri obblighi e che operano conformemente al regolamento REACH
 - * relativa dichiarazione di prodotti/sostanze non ricadenti nelle disposizioni previste dal regolamento REACH
 - * Impegno ad informare tempestivamente TITAN ENGINEERING SPA nel caso di variazioni/aggiornamenti riguardanti le sostanze di cui al regolamento REACH
- Informiamo altresì che TITAN ENGINEERING SPA effettua attività di assemblaggio e commercializzazione, non alterando in alcun modo le sostanze contenute nei prodotti acquistati dai propri Fornitori sia come finiti, che come semilavorati.

Directive 2011/65 / EU (RoHS 2)

TITAN ENGINEERING SPA manufactures and sells fittings and accessories for the air pneumatic circuits that could be used as components/accessories in electrical and electronic equipment, where, according to Directive 2011/65 / EU (RoHS 2) in Annex II, is prescribed a content of substances "with restricted use" within the following values:

Lead (0,1%) • Mercury (0.1%) • Cadmium (0.01%) • Hexavalent chromium (0.1%) • Polybrominated biphenyls (PBB) (0.1%) • Polybrominated diphenyl ethers (PBDE) (0.1%) •

According to statements made by our suppliers, we declare that the following products, manufactured and marketed by us, and illustrated in this catalog:

- PUSH-IN BRASS FITTINGS
- PUSH-IN TECHNOPOLYMER FITTINGS
- BRASS AND POLYMER SPEED CONTROLLERS
- BRASS STEMS
- COMPACT AND STAINLESS STEEL PUSH-IN FITTINGS
- STANDARD LINE BRASS FITTINGS
- COMPRESSED BRASS FITTINGS
- QUICK BRASS FITTINGS

are belong to, in exemption to the values stated above, to the products in aluminum, steel and copper alloys and brass, Annex III hereto, which explicitly defines the types and relative limits.

Regulation EC 1907/2006 (REACH)

According to statements made by our suppliers, TITAN ENGINEERING SPA declares that it has obtained:

- * Its statement to the effect that the suppliers themselves are aware of their obligations and operating in accordance with REACH
 - * Relevant declaration of products / substances not covered by points available under REACH
 - * Commitment from suppliers themselves to inform TITAN ENGINEERING SPA in case of changes/updates regarding the substances under REACH regulation
- We also inform that TITAN ENGINEERING SPA performs assembly and marketing activities, without altering in any way the substances contained in the products, finite, or as semi-finished, purchased from its suppliers.

HEADQUARTERS - PNEUMAX S.p.A.

24050 Lurano (BG) - Italia
Via Cascina Barbellina, 10
Tel. 035/4192777
Fax 035/4192740 - 035/4192741
info@pneumaxspa.com
www.pneumaxspa.com

PIEMONTE - LIGURIA - VALLE D'AOSTA**PNEUMAX TORINO S.r.l.**

Corso Allamano, 34
10095, Grugliasco (TO)
Tel. 011 4143656
info@pneumaxtorino.com
www.pneumaxtorino.com

**VENETO - FRIULI VENEZIA GIULIA
TRENTINO ALTO ADIGE****PNEUMAX VENETO S.r.l.**

V.le della Tecnica, 15
36100, Vicenza (VI)
Tel. 0444 289011
info@pneumaxveneto.it
www.pneumaxveneto.it

**MARCHE****PNEUMATEC S.r.l.**

Via Ancona, 42
61010, Tavullia (PU)
Tel. 0721 202762
info@pneumatec.it
www.pneumatec.it

LOMBARDIA**PNEUMAX MILANO BRIANZA S.r.l.**

Via Alberto I° re dei Belgi, 13
20900, Monza (MB)
Tel. 039 736176
info@pneumaxmb.it
www.pneumaxmilanobrianza.it

**EMILIA-ROMAGNA****AIR FLUID CENTER S.r.l.**

Via Machiavelli, 38B
29121, Piacenza (PI)
Tel. 0523 490800
info@airfluidcenter.com
www.airfluidcenter.com

**TOSCANA****PNEUMAX TOSCANA S.r.l.**

Via Bruno Sarri, 20/A
50019, Sesto Fiorentino (FI)
Tel. 055 8071307
info@pneumaxtoscana.it
www.pneumaxtoscana.it

**PNEUMAX SERVICE S.r.l.**

Via Mons. Portaluppi, 13
24049, Verdello (BG)
Tel. 035 4820540
info@pneumax-service.it
www.pneumax-service.it

**A.I.R. PNEUMATIC CENTER S.r.l.**

Via J. Gutenberg, 6
47822, Santarcangelo
di Romagna (RN)
Tel. 0541 624314
info@airpneumatic.it
www.airpneumatic.it

**UMBRIA****OLEODINAMICA PALMERINI S.r.l.**

Via dell'industria, 6
06135, Perugia (PG)
Tel. 075 398541
oleodinamica@palmerini.com
www.palmerini.com

FLUIDMEC S.p.A.

Via Gussalli, 4
25131, Brescia (BS)
Tel. 030 2686511
fluidmec@fluidmec.it
www.fluidmec.it

**F.I.A.P. S.p.A.**

Via Palach, 75
41122, Modena (MO)
Tel. 059 311084
info@fiapsa.it
www.fiapsa.it

**ABRUZZO - BASILICATA - CAMPANIA -
CALABRIA - LAZIO - MOLISE - PUGLIA
SARDEGNA - SICILIA****INTERFLUID S.R.L.**

Via Lazzaretto, 10 F
21013, Gallarate (VA)
Tel. 0331 772410
info@interfluid.it
www.interfluid.it

F.I.P. S.p.A.

Via B. Franklin, 31
43122, Parma (PR)
Tel. 0521 606132
info@fipsrl.it
www.fipsrl.it

**PNEUMAX SUD S.r.l.**

Via dei Bucaneve, SNC
70026, Modugno (BA)
Tel. 080 9645904
info@pneumaxsud.it
www.pneumaxsud.it





EUROPA

ALBANIA

IAS Industrial Air Solution shpk
Rruga industriale Tirane Vore, km 11,
Vorë 1032
Tel. +355 69 408 0349
info@iasolution.al
www.iasolution.al

AUSTRIA E SVIZZERA

Gestito da Pneumax GmbH (Germania)

BELGIO

Pneuvano BV
Koralenhoeve 4
2160, Wommelgem
Tel. +32 3 355 32 20
info@pneuvano.com
www.pneuvano.com

BULGARIA

Ulmer DM OOD
Adam Mizkevich Str. 4a, 1360, Sofia
Tel. +359 (2) 9259951
office@ulmer.bg
www.ulmer.bg

CIPRO

G C V Spare Parts & Services Ltd
Industrial Area, Anatoniko 8086
P.O. Box 62731, Paphos
Tel. +357 26812444
gcv.cy@cytanet.com.cy
www.gcv-parts.com

CROAZIA

ProElektronika d.o.o. - Zagabria
Stefanovecka 10, 10040, Zagabria
Tel. +385 (0)1 5588 988
info@proelektronika.hr
www.proelektronika.hr

ESTONIA

Alas-Kuul AS
Loomäe tee 1, Lehmja küla
75306, Rae vald Harjumaa
Tel. +372 6593 218
info@alas-kuul.ee
www.alas-kuul.com

FRANCIA

Pneumax France SAS
Z.I. NORD PARADIES 7
Rue de Waldkirch - BP 42
67601, Selestat CEDEX
Tel. +33 (3) 88580450
commercial@pneumax-france.fr
www.pneumax-france.fr



GERMANIA

Pneumax GmbH
Tantalstraße 4
63571, Gelnhäusen
Tel. +49 (0) 6051 9777 0
info@pneumax-gmbh.de
www.pneumax.de



GRECIA

Hydropneumatic Hellas S.A.
69, Spirou Patsi Str. T.K., 118 55, Atene
Tel. +30 (210) 3474181-2-3
info@mitsis.com.gr
www.mitsis.com.gr

INGHILTERRA

Pneumax UK Ltd.
110 Vista Park,
Mauretania Road
SO16 OYS, Nursling
Tel. +44 2380 740412
sales@pneumax.co.uk
www.pneumax.co.uk

ISLANDIA

Barki E.H.F. Ltd
Nybylavegi 22, 200, Kópavogur
Tel. +354 554 6499
barkiea@islandia.is

LITUANIA

UAB "Domingos prekyba"
Savanoriu PR 187-4 Korp, 2053, Vilnius
Tel. +370 5 2322231
info@dominga.lt
www.dominga.lt

MACEDONIA DEL NORD

DIL KOM DOOEL
St. Joska Jordanoski No 657500, Prilep
Tel. +389 78244177
export.dilkom@gmail.com
www.dilkom.mk

MALTA

iAUTOMATE LIMITED
San Bernard, Marsa MRS 1332, Malta
Tel. +356 2786 3996
matthew@iautomate.mt
www.iautomate.mt

OLANDA

Pneu/Tec B.V.
Dirk Storklaan 75, 2132 PX, Hoofddorp
Tel. +31 (0) 235699090
sales@pneutech.nl
www.pneutech.nl

POLONIA

RECTUS POLSKA SP. Z.O.O.
Gumna 96, 43-426, Debowiec
Tel. +48 (33) 857 98 00
pneumax@pneumax.pl
www.pneumax.pl

PORTOGALLO

Portugal Pneumax Lda
Complexo Industrial da
Granja Fracção H-Casarias
2625-607, Vialonga
Tel. +351 (219) 737390
geral@pneumax.pt
www.pneumax.pt



REPUBBLICA CECA

Pneumax Automation s.r.o.
U Panského mlýna 240/9,
747 06, Opava
Tel. +420 553 760 953
pneumax@pneumaxsro.cz
www.pneumaxsro.cz



ROMANIA

Gica Import Export
Zona Industrială de Vest str. II nr. 5,
310491, Arad
Tel. +40 257 259816
comercial@gica.ro
www.gica.ro

RUSSIA / CIS

Pneumax Ltd. Moscow
Kommunalniy proezd, 30
141400, Khimki
Tel. +7 495 7393999
mail@pneumax.ru - www.pneumax.ru

DANIMARCA - FINLANDIA NORVEGIA - SVEZIA (SCANDINAVIA)



Pneumax Scandinavia AB
Strandvägen 101, SE-234 31, Lomma
Tel. +46 (40) 617 40 40
info@pneumax.se - www.pneumax.se

SERBIA

Hidraulika DOO
Cirila i Metodija 15, 15000, Šabac
Tel. +381 15 360 090
info@hidraulika.rs - www.hidraulika.rs

SLOVENIA

Hidravlika d.o.o.
Medlog, 16, 3000, Celje
Tel. +386 (3) 5453610
info@hidravlika.si - www.hidravlika.si

SPAGNA

Pneumax S.A.
Olaso Kalea, 54, 20870, Elgoibar
Tel. +34 943 744144
pneumax@pneumax.es - www.pneumax.es



Pneumax Catalunya S.A.

C/Riera de Vallvidrera,
Parc. 2N. 1 P.I. Riera del Moli
8750, Molins de Rei
Tel. +34 (93) 680 25 30
pneumax@pneumaxcat.com
www.pneumax.es



TURCHIA

Eteknik Otomasyon Tic. Ltd. Sti
Perpa Ticaret Merkezi B Blok Kat:11 No:1636
Okmeydanı Sisli (Istanbul)
Tel. +90 212 320 81 10
recepakar@eteknik.com
www.eteknik.com

UCRAINA

UKRTECHTRONIC LLC.
st. Nyzhnyurkivska, 9, 04080, Kiev
Tel. +38 044 500 98 48
sales@techtronic.com.ua
www.techtronic.com.ua

UNGHERIA

Szele-Tech Bt.
Gvadányi u. 33-39. I. em. 108., 1141,
Budapest
Tel. +36 1 401 0023
info@szele-tech.huwww.szele-tech.hu

AMERICA DEL NORD

CANADA

Manufacture Scorpion Inc.
561, rue Edouard, J2G 3Z5, Granby
Tel. +1 (450) 378-3595
contact@mscorpion.com
www.manufacturescorpion.com

STATI UNITI D'AMERICA

Pneumax Automation LLC
128 Durkee Lane, Dallas
NC 28034 - USA
Tel.: +1 704 215 6991
Fax: +1 888 613 6529
info@pneumax.us
www.pneumax.us



MESSICO

Pneumatecnia S.A. DE C.V. - Zapopan
Calle Volcán Popocatépetl 1844, Colli Urbano
45070, Zapopan, Jalisco
Tel. +52 33 31255978
pneumatecnia@yahoo.com.mx
www.pneumatecnia.com.mx

AMERICA CENTRALE

COSTA RICA

PYASA Proyectos y Automatización S.A.
Oficentro Santa María Oficina 1A,
50 metros Norte
Del Hampton Inn & Suites, Alajuela
Tel. +506 2441-5129 / 2441-5130
info@pyasa.net
https://pyasa.net

EL SALVADOR

TECNI EQUIPOS S.A. de C.V.
Av. Sierra Nevada, 704 Edificio CC, 2
Colonia Miramonte, San Salvador
Tel. (503) 2260-8293
Tel. (503) 2261-1497
tecniequpos.com.sv

GUATEMALA

PYASA Proyectos y Automatización S.A.
Avenida 3era 13-30 El Rosario Ofibodegas
San Javier zona 3 de Mixco bodega 7
Città del Guatemala
Tel. +502 24911414
info@pyasa.net
https://pyasa.net

NICARAGUA

PYASA Proyectos y Automatización S.A.
Plaza Maranhao, local 7, Reparto Los Robles, o
bien, del Hotel Seminole 100 m sur,
1/2 m al oeste
Managua
Tel. +505-2255-6840
info@pyasa.net
https://pyasa.net

AMERICA DEL SUD

ARGENTINA

Figli Daniele S.r.l.
PTE PERON 3234
San Justo - Pcia De Bs As.
Tel. +54 11 4484-2074
Fax +54 11 4651-6721
Email: bruno@dinautomacion.com.ar

BRASILE

Pneumax Brasil
Rua Apucarana 211
8301050, São José dos Pinhais
Tel. +55 41 33987262
diretoria@pneumaxbr.com.br
www.pneumaxbr.com.br



CILE

Schultz Automatizacion e Ingenieria Ltda
El Retiro 1247 - Enea - Pudahuel, Santiago
Tel. +56 (2) 4951400
jschultz@schultzautomatizacion.cl
www.schultzautomatizacion.cl

COLOMBIA

Soluciones Neumaticas S.A.S.
Calle. 21 #1-21, Barrio San Nicolas, Cali
Tel. +57 (2) 4897647
ingenieria@solucionesneumaticas.com
www.solucionesneumaticas.com

ECUADOR

AINSA S.A Guayaquil City
Av. Juan Tanca Marengo
Km 2,5 y Agustín Freire
EC090509, Guayaquil City
Tel. +593-4 3712670
info@ainsa.com.ec - www.ainsa.com.ec

PERÙ

Neumatec Perú S.A.C.
Calle General Suárez 1023,
Miraflores, Lima 18
Tel. +51 (1) 4442499
ventas@neumatecperu.com
www.neumatecperu.com

WEF Perú S.A.C.

Jr. Dinamarca 1427,
LIMA 01, Cercado de Lima
Tel. +511 4255740
oficinacentral@wefperu.com
www.wefperu.com

URUGUAY

Secoin S.A
General Aguilar 1270 bis,
Gral. Fausto Aguilar 1270,
11800 Departamento de Montevideo
Tel. +598 2209 3815
ventas@secoin.com.uy
www.secoin.com.uy

VENEZUELA

Sinteco Barquisimeto
AV.Las Industrias Km2,
Edif. Centro de servicios
mercantiles local 2, Barquisimeto
Tel. +58 251 4432555
sintecobarqto@cantv.net
www.sintecobarqto.com.ve

AFRICA

ALGERIA

C.M.P.R. Sarl
23 Rue Lalla Fatma N'Soumeur Hassen
Badi EL-Harrach, Algeri
Tel. +213 21 82 70 69

EGITTO

Egyptian Engineering
Shop 6 building no 1 Jordan co.
10th Of Ramadan City, Egitto
Tel. +20554368385
Fax: +20554368385
Email: info@eefhydropneu.com
www.eefhydropneu.com

Technical Center For Machinery Supplies

65 Gesr Elsues St., El sallam, Cairo
Tel. +20 (2) 26989348
tcms@fluidspower.net
www.tcms.fluidspower.net

GHANA

Cemix Limited
34 SPINTEX ROAD-ACCRA-GHANA-WEST
Tel. +233 0302 817030
sales@cemixghana.com
www.cemixghana.com

MAROCCO

R2i TFZ
Ilot 87, 1er étage, Bureau 20,
zone franche d'Exportation Tanger
Tel. +212 539 39 10 17
r2itfz@r2imaroc.ma
www.r2itfz.com

TUNISIA

L'Equipement moderne
86, Av. de Carthage, 1000, Tunisi
Tel. +216 71 343844
equipement.moderne@planet.tn
www.lequipementmoderne.com

ASIA

ARABIA SAUDITA

Arabian Universal Establishment for Trading

Southern Shopping Center, P.O BOX 3105
21471, Jeddah
Tel. +966 26 477159
www.arabianuniversal.com

CINA

Pneumax Pneumatic Equipments Co., Ltd.

No. 76, Jinma Rd., Jiufu Economic
Development Zone, Jiuting Town
201615, PRC, Shanghai
Tel. +86 (21) 57763100
sales@pneumaxchina.com
www.pneumaxchina.com



EMIRATI ARABI UNITI

Fine Industrial & Agri ENG. Services

P. O. BOX 5763, Sharja UAE
Tel. +971 (6) 5335434
fineinds@emirates.net.ae

FILIPPINE

INTEGRATED HYDRO-PNEUMATIC SYSTEMS, INC.

N°4 St. Thomas Avenue,
Lopez Commercial Area
Sucat, Parañaque City
Tel. +632 02 820-0569
integhps@iconex.net

GIORDANIA

Al Sultan Company for Industrial Equipment

P.O. Box 620996
11162, Amman
Tel: + 962 6 4753764
omar@alsultanco.com - www.alsultanco.com

Technical Center for Machinery Supplies

P.O. Box 11317 - 11123, Amman
Tel: +962 6 4746901
techno@fluidpower.net

INDIA

Pneumax Pneumatic India Pvt. Ltd.

D-82, Hosiery Complex, Phase-II extn.
201305, Noida, UP
Tel. +91 (120) 4352560 / 61 / 62
info@pneumax-india.com
www.pneumax-india.com



INDONESIA

Gestito da Pneumax Singapore Pte Ltd

PT. Mutiara Citramulia Teknindo

Ruko Karawaci Residence Blok A1,
No. 17 Jl. Raya
Legok. Bojong Nangka Kelapa Dua
Serpong-Tangerang 15810, Banten, 15810,
Giacarta
Tel. +62 21 29324792
pneumaxmct@cbn.net.id
www.pneumaxspa.com/ENG

IRAN

Ital Electro Pneumatic

NO. 204-2ND FLOOR-TAGHINIA
BLDG-SOUTH SA'ADI STREET
114715719, Teheran
Tel. +98 (21) 33919177
info@italpneum.com

ISRAELE

Ilan & Gavish

Yokneam Ilit 20692
POB 335, Soltam Site
Tel. +972 3 9221824
mail@ilan-gavish.com
www.ilan-gavish.co.il

LIBANO

Yamine Trading Company SARL

Boushrieh, Industrial City, P.O. Box 90 684
Jdeideh, El Metn 1202
2060, Beirut
Tel. +961 1 885520
info@yamminetrading.com
www.yamminetrading.com

MALESIA

Gestito da Pneumax Singapore Pte Ltd

PSI Pneumatic Control Sdn Bhd

4M (1) Desa Universiti Commercial Complex,
Jalan Sungai Dua
11700, Penang
Tel. +60 4 6592627
sales-psi@airdynamics.com.sg

OMAN

Sifat National L.L.

4016 -Al Ghubra,Opp: Mars Hyper Market
PO BOX: 185, PC: 118, Muscat
Tel. +968 9746 7950, 24137684
sales@sifatoman.com
www.sifatoman.com

PAKISTAN

Fluid Tekhnik

Suite 101-104 Industrial Town Plaza, Opp. Sind
Madressah, Shahrah-e-Liaquat
74000, Karachi
Tel. +92 (21) 2410335
info@fluid-technik.com.pk
www.fluid-technik.com.pk

SINGAPORE

Pneumax Singapore Pte Ltd

51, Ubi Avenue 1/ 01-16,
Paya Ubi Industrial Park
408933, Singapore
Tel. +65 6392 0581
sales@pneumax.com.sg
www.pneumax.com.sg



SIRIA

Al Rowad Trading

P.O. BOX. 12806
Damasco
Tel: +963 944 228 955
alrowadtrading01@hotmail.com

THAILANDIA

Thai Agency Engineering Co. LTD

9 Soi Yasooop 2, 2nd-3rd Floor, Vorasin
building, Vipavadirangsit Road, Ladyao
10900, Chumphon
Tel: +66 (2) 6915900
taec@bkk.loxinfo.co.th
www.thai-a.com

OCEANIA

AUSTRALIA

Air & Automation Equipment Ltd.

3-9 Herbert Street
2137 N.S.W., Mortlake
Tel. +61 (2) 9743 1271
airauto@ihug.com.au
www.airautomation.com.au

NUOVA ZELANDA

TREOTHAM New Zealand Limited

13 C Vogler Drive, Wiri,
Po box 201033 Auckland Airport 2150
Wiri, Auckland 2104
info@treotham.co.nz
www.treotham.co.nz

TREOTHAM New Zealand Limited

26 Tawn Place
P. O. BOX 5656, Hamilton (Pukete)
Tel. +64 7 8490281



PNEUMAX

PNEUMAX S.p.A.

Via Cascina Barbellina, 10
24050 Lurano (BG) - Italy
P. +39 035 41 92 777
info@pneumaxspa.com
www.pneumaxspa.com

Sede produttiva

TITAN ENGINEERING S.p.A.
Via dei Cerri, 16/18
47899 Zona Artigianale Ciarulla RSM
(C.O.E. SM 04813)
P. +39 0549 96 11 21
info@titanengineering.sm
www.titanengineering.sm