

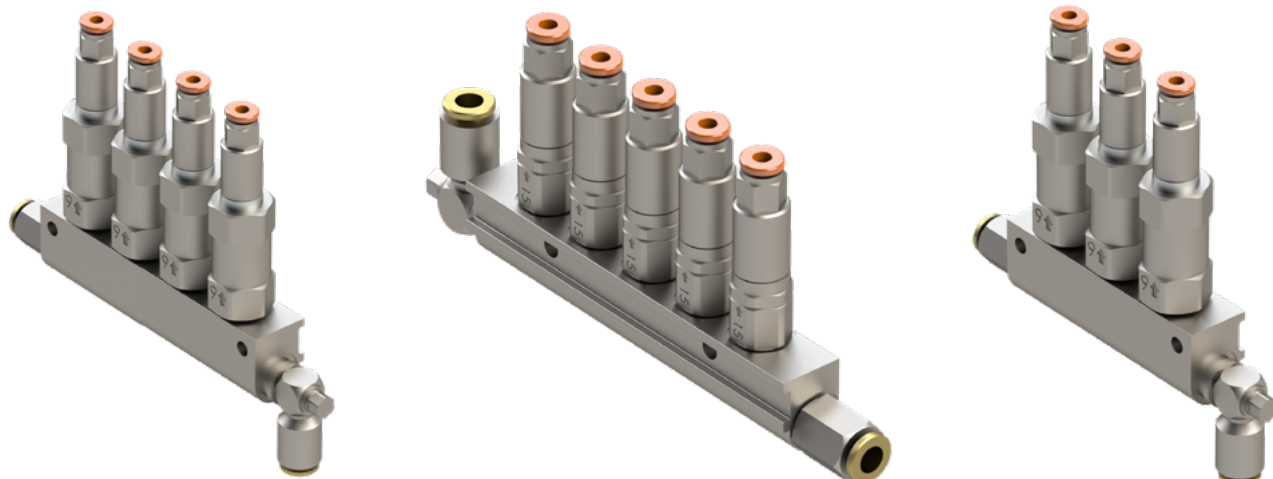

ILCOMATIC 3

VALVOLE DOSATRICI VOLUMETRICHE
PER FUNZIONAMENTO AD OLIO E GRASSELLO



Informazioni generali	3
Funzionamento	4
Struttura sistema	5
Valvole per Distributore	6
Dimensioni valvole per Distributore	7
Valvole per Punto	8
Terminali girevoli	9
Distributori	10
Distributori unilaterali	12
Valvole dosatrici a pistone	13
Raccordi	14



Tutti i prodotti ILC devono essere usati esclusivamente per gli scopi previsti, come specificato in questa brochure e in tutte le istruzioni. Se il prodotto viene fornito insieme alle istruzioni per l'uso, l'utente è tenuto a leggerle e rispettarle. Per i sistemi di lubrificazione centrali non tutti i lubrificanti sono idonei. I sistemi di lubrificazione ILC o i relativi componenti non possono essere usati in combinazione con gas, gas liquidi, gas pressurizzati in soluzione e liquidi la cui pressione di vapore superi la normale pressione atmosferica (1013 mbar) di oltre 0,5 bar, temperatura massima consentita. I materiali pericolosi di qualsiasi tipo, in particolare quelli classificati come tali dalla Direttiva della Comunità Europea EC 67/548/CEE, Articolo 2 (2), possono essere usati nei sistemi di lubrificazione centralizzati ILC o dei relativi componenti solo previa consultazione con ILC e dopo aver ricevuto il consenso scritto da parte dell'azienda.

Dati tecnici

Lubrificanti	Olio 32 cSt – 2000 cSt	
	Grasselli NGLI 000-00	
Temperatura	da 0 °C a 80 °C	
Tenute	NBR	
	VITON (su richiesta)	
Pressione di lavoro	Da 12 bar a 50 bar	per portate 15-30-60-100-160-500-750-1000 mm ³
	Da 15 a 50 bar	per portate 200-300 mm ³
Pressione massima di rilascio	2,5 bar	portate 15-30-60-100-160 mm ³
	2 bar	per le per le portate 200-300 mm ³
	2 bar	portate 500-750-1000 mm ³
Tempo di pausa minimo	15"	per Olii da 32 a 250 cSt
	200"	per Olii da 260 a 2000 cSt e grasselli nligi 00

Importante: i dati riportati sopra sono teorici e soggetti a variazione in base all'estensione dell'impianto, alle dimensioni della tubazione principale, al tipo di lubrificante utilizzato e alla temperatura di lavoro.

Informazioni generali

Le valvole dosatrici ilcomatic 3 trovano applicazione in impianti di lubrificazione centralizzata funzionanti a olio o grassello. Possono essere installate su distributori di alluminio unilaterali o bilaterali o direttamente sul punto da lubrificare. Per un corretto funzionamento la pressione di linea non deve essere inferiore a 15 bar con una spinta di mandata anche molto lenta.

L'erogazione del lubrificante avviene con pompa in funzione al raggiungimento della pressione necessaria. La predisposizione delle valvole ad una successiva erogazione di lubrificante avviene all'arresto della pompa e conseguentemente al rilascio della pressione nelle linee principali. Possono essere utilizzate in impianti di medie e grandi dimensioni aventi un elevato numero di punti.

Applicazioni Principali: macchine utensili, macchine per il legno, macchine tessili, macchine per l'imballaggio, macchine per la plastica, macchine per il vetro, macchine per la stampa e in generale dove sia necessario inviare una quantità precisa di lubrificante.

Funzionamento

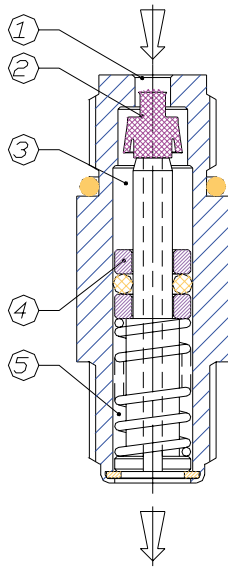

Azionando La Pompa Al Foro (1) Arriva La Pressione Che Mediante Il Restringimento Del Labbro Della Valvola (2) Permette L'entrata Del Lubrificante Nella Camera (3) Spostando Di Conseguenza Il Pistone (4) Il Quale Eroga La Portata In Precedenza Accumulata Nella Camera (5).

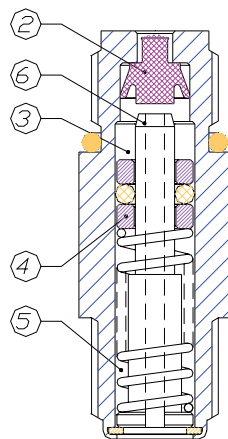

Nella Fase Di Rilascio Il Pistone (4), Spinto Dalla Molla, Ritorna Nella Posizione Iniziale. Nel Suo Movimento Allontana La Valvola Di Tenuta (2), Si Apre Il Foro (6) E Il Lubrificante Si Trasferisce Dalla Camera (3) Alla (5).

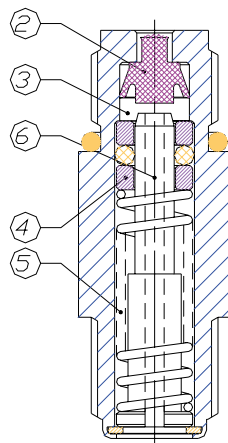

Il Pistone (4) Ha Completato La Sua Corsa. Il Lubrificante Si È Trasferito Completamente Dalla Camera (3) Alla (5). La Valvola Di Tenuta (2) Ha Chiuso Il Foro (6). La Valvola Dosatrice È Pronta Per Un Nuovo Ciclo.

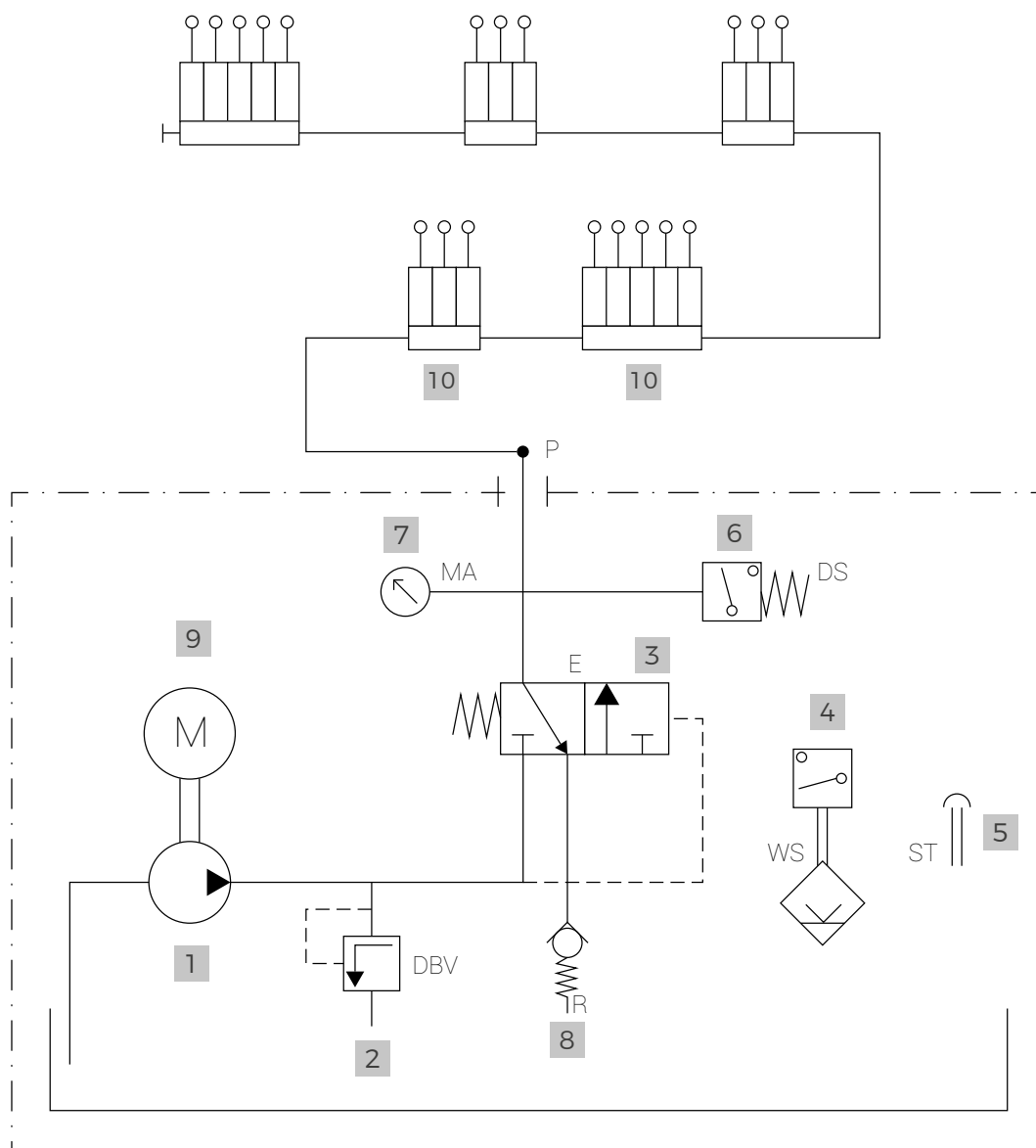

- | | | | |
|----------|--|-----------|--------------------------------------|
| 1 | pompa a ingranaggi (CME o MPT) | 6 | pressostato controllo pressione olio |
| 2 | valvola di massima pressione | 7 | manometro |
| 3 | valvola di rilascio | 8 | valvola di aspirazione |
| 4 | controllo del minimo livello di lubrificante | 9 | motore elettrico |
| 5 | filtro di caricamento del lubrificante | 10 | valvole dosatrici |

M10x1 (M) - M10x1 (M)



Codice	Portata	Mark
02.709.0	15 mm ³	15
02.709.1	30 mm ³	30
02.709.2	60 mm ³	60
02.709.3	100 mm ³	100
02.709.4	160 mm ³	160
02.709.5	200 mm ³	200
02.709.6	300 mm ³	300



Codice	Portata	Mark
02.601.6	500 mm ³	6
02.601.7	750 mm ³	7
02.601.8	1000 mm ³	8

M10x1 (M) - PUSH IN



Codice	Portata	Mark
02.710.0	15 mm ³	15
02.710.1	30 mm ³	30
02.710.2	60 mm ³	60
02.710.3	100 mm ³	100
02.710.4	160 mm ³	160
02.710.5	200 mm ³	200
02.710.6	300 mm ³	300



Codice	Portata	Mark
02.710.7	500 mm ³	6
02.710.8	750 mm ³	7
02.710.9	1000 mm ³	8

M10x1 (M) - M8x1 (F)



Codice	Portata	Mark
02.713.0	15 mm ³	15
02.713.1	30 mm ³	30
02.713.2	60 mm ³	60
02.713.3	100 mm ³	100
02.713.4	160 mm ³	160
02.713.5	200 mm ³	200
02.713.6	300 mm ³	300

M1/8" (M) - M10x1 (M)



Codice	Portata	Mark
02.739.0	15 mm ³	15
02.739.1	30 mm ³	30
02.739.2	60 mm ³	60
02.739.3	100 mm ³	100
02.739.4	160 mm ³	160
02.739.5	200 mm ³	200
02.739.6	300 mm ³	300

M1/8" (M) - PUSH IN



Codice	Portata	Mark
02.742.0	15 mm ³	15
02.742.1	30 mm ³	30
02.742.2	60 mm ³	60
02.742.3	100 mm ³	100
02.742.4	160 mm ³	160
02.742.5	200 mm ³	200
02.742.6	300 mm ³	300

M1/8" (M) - 5/16" (M)



Codice	Portata	Mark
02.737.0	15 mm ³	15
02.737.1	30 mm ³	30
02.737.2	60 mm ³	60
02.737.3	100 mm ³	100
02.737.4	160 mm ³	160
02.737.5	200 mm ³	200
02.737.6	300 mm ³	300

Le tenute sono in NBR. A richiesta sono disponibili valvole con tenute in Viton, aggiungere la lettera "V" al codice come ad esempio 02.709.0.V

M10x1 (M) - M10x1 (M)

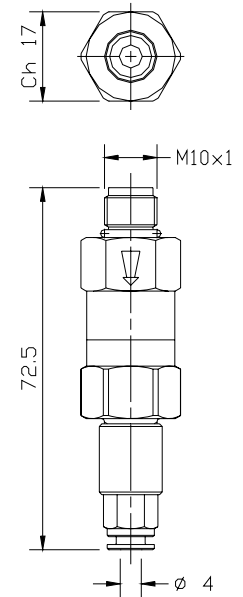
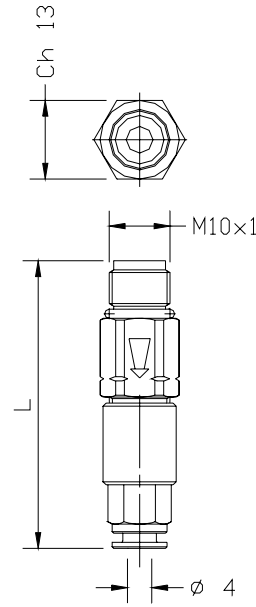
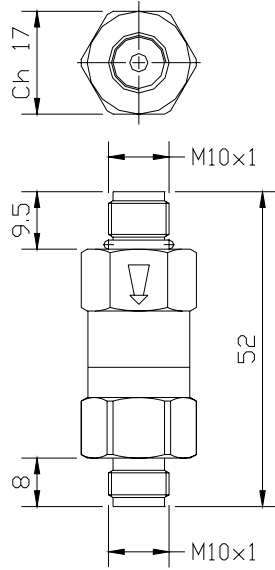
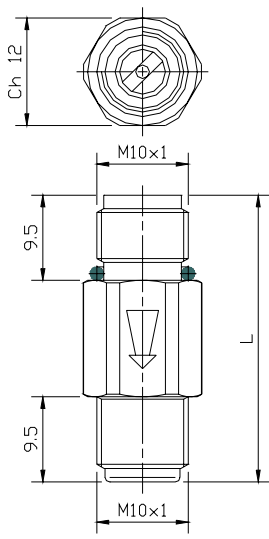

Codice	L	Codice	L	Codice	L	Codice	L
02.709.0/4	32 mm	02.601.6/8	52 mm	02.710.0/4	51 mm	02.710.6/8	72.5 mm
02.709.5/6	37.6 mm			02.710.5/6	56.5 mm		

M10x1 (M) - M8x1 (F)

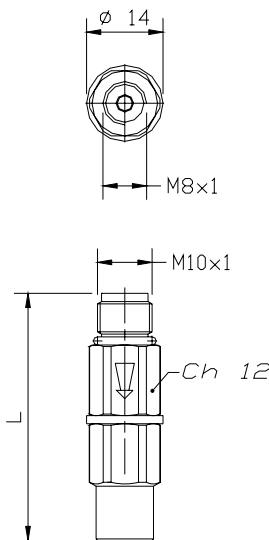

M1/8" (M) - PUSH IN

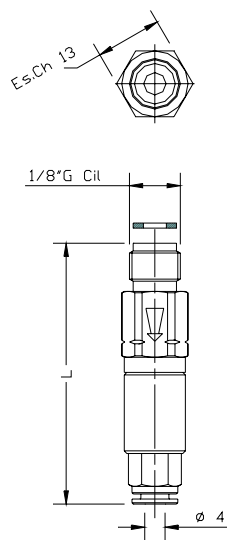

M1/8" (M) - M10x1 (M)

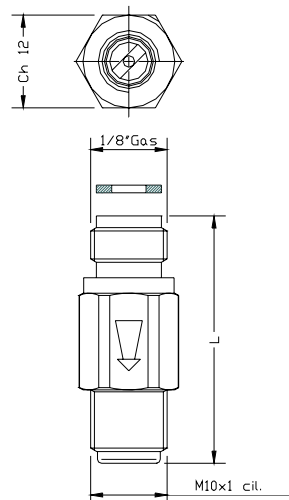

M1/8" (M) - 5/16" (M)

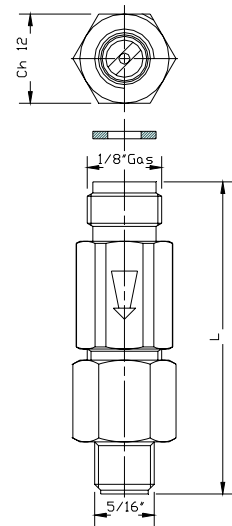

Codice	L	Codice	L	Codice	L	Codice	L
02.713.0/4	45.5 mm	02.742.0/4	51 mm	02.739.0/4	32 mm	02.737.0/4	42 mm
02.713.5/6	51.1 mm	02.742.5/6	56.6 mm	02.739.5/6	37.6 mm	02.737.5/6	47.6 mm

M10x1 (M) - 1/8" (M) Dritte

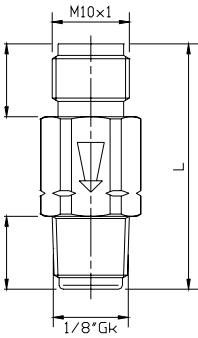
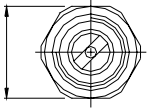

Codice	Portata	Mark
02.711.0	15 mm ³	15
02.711.1	30 mm ³	30
02.711.2	60 mm ³	60
02.711.3	100 mm ³	100
02.711.4	160 mm ³	160
02.711.5	200 mm ³	200
02.711.6	300 mm ³	300

Codice	L
02.711.0/4	32 mm
02.711.5/6	37.6 mm

M10x1 (M) - 1/4" (M) Dritte

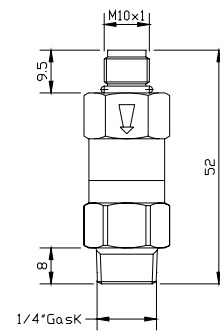
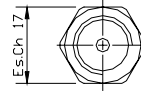
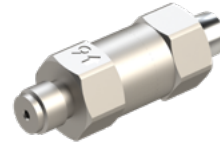

Codice	Portata	Mark
02.602.6	500 mm ³	6
02.710.1	750 mm ³	7
02.710.2	1000 mm ³	8

Codice	L
02.602.6/8	51 mm

5/16" (M) - 1/8" (M) Dritte

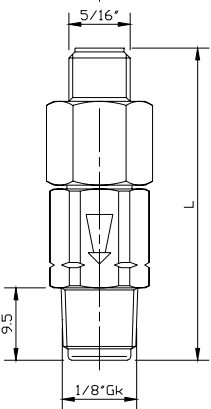
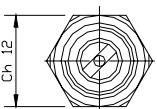

Codice	Portata	Mark
02.736.0	15 mm ³	15
02.736.1	30 mm ³	30
02.736.2	60 mm ³	60
02.736.3	100 mm ³	100
02.736.4	160 mm ³	160
02.736.5	200 mm ³	200
02.736.6	300 mm ³	300

Codice	L
02.736.0/4	41 mm
02.736.5/6	46.6 mm

PUSH IN - 1/8" (M) Dritte

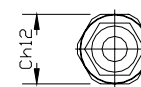
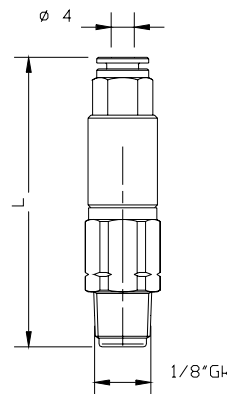

Codice	Portata	Mark
02.712.0	15 mm ³	15
02.712.1	30 mm ³	30
02.712.2	60 mm ³	60
02.712.3	100 mm ³	100
02.712.4	160 mm ³	160
02.712.5	200 mm ³	200
02.712.6	300 mm ³	300

Codice	L
02.712.0/4	46.5 mm
02.712.5/6	52.1 mm

Le tenute sono in NBR. A richiesta sono disponibili valvole con tenute in Viton, aggiungere la lettera "V" al codice come ad esempio 02.709.0.V

09.015.0

09.016.0

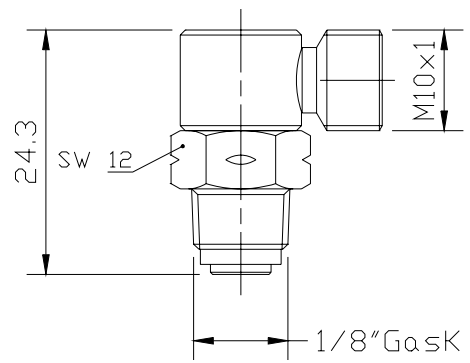
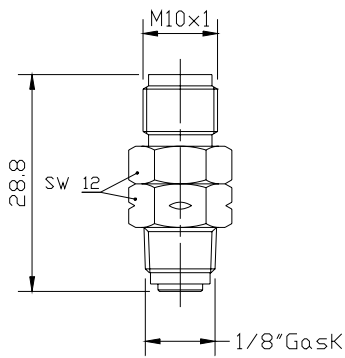
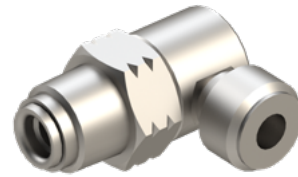
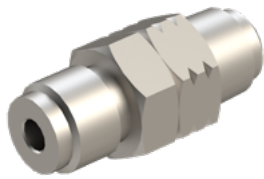

09.018.0

09.020.0

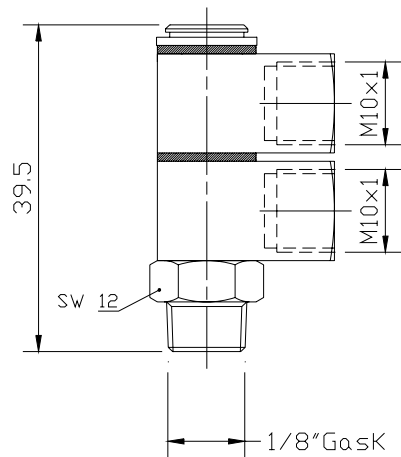
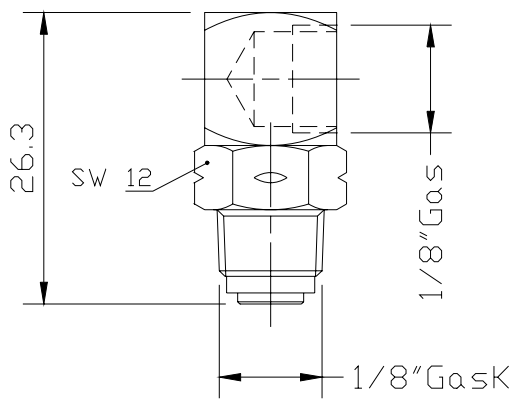
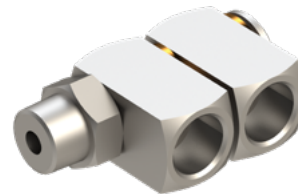
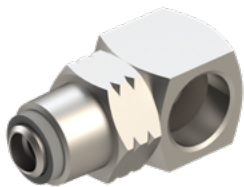

M12x1 - M10x1

Unilaterali



Codice	Uscite	A	B
01.520.0	1	40	20
01.521.0	2	61	41
01.522.0	3	82	62
01.523.0	4	103	83
01.524.0	5	124	104
01.525.0	6	145	125
01.526.0	7	166	146
01.527.0	8	187	167
01.528.0	9	208	188
01.529.0	10	229	209

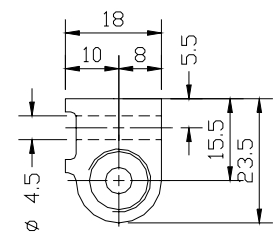
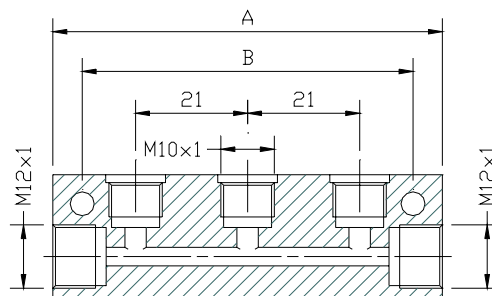

Bilaterali



Codice	Uscite	A	B
01.540.0	2	40	20
01.541.0	4	61	41
01.542.0	6	82	62
01.543.0	8	103	83
01.544.0	10	124	104
01.545.0	12	145	125
01.546.0	14	166	146

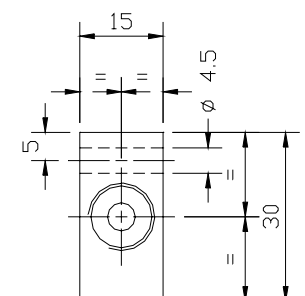
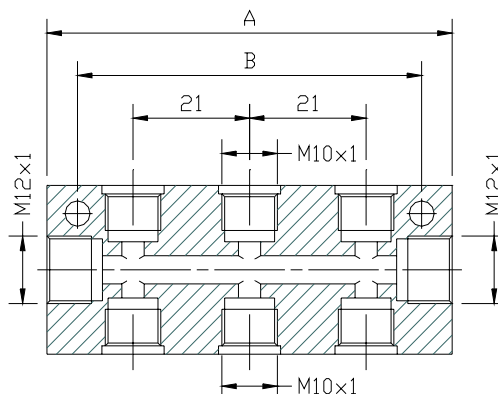

1/8" - 1/8"

Unilaterali



Codice	Uscite	A	B
01.420.0	1	40	20
01.420.1	2	61	41
01.420.2	3	82	62
01.420.3	4	103	83
01.420.4	5	124	104
01.420.5	6	145	125
01.420.6	7	166	146
01.420.7	8	187	167
01.420.8	9	208	188
01.420.9	10	229	209

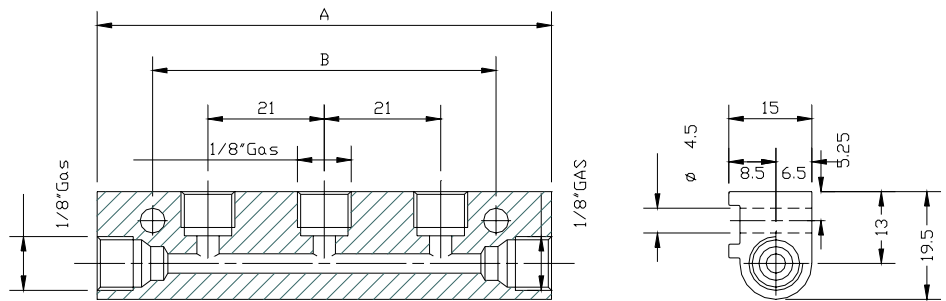

Bilaterali

Codice	Uscite	A	B
01.421.0	2	40	20
01.421.1	4	61	41
01.421.2	6	82	62
01.421.3	8	103	83
01.421.4	10	124	104
01.421.5	12	145	125
01.421.6	14	166	146

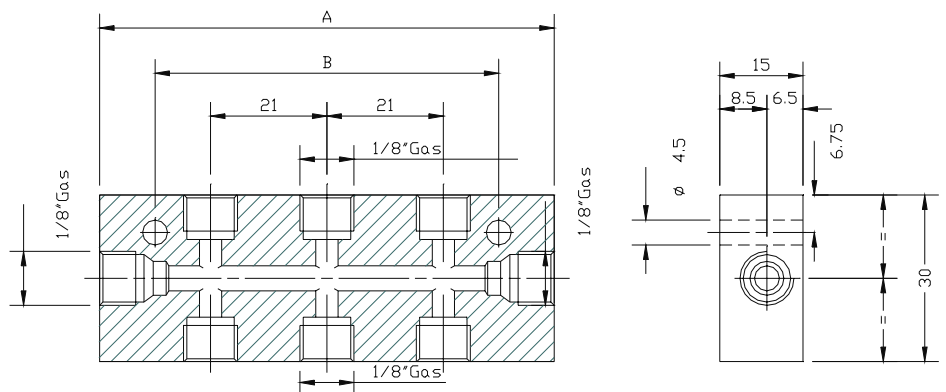

M10x1 - M10x1 2 Vie

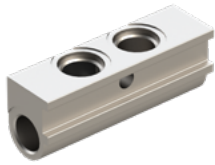

Codice 01.961.0

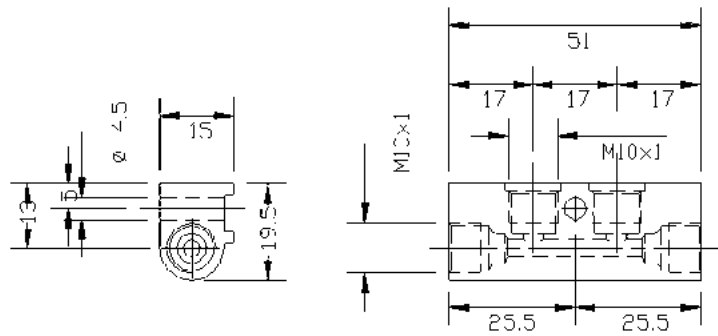

M10x1 - M10x1 3 Vie



Codice 01.961.1

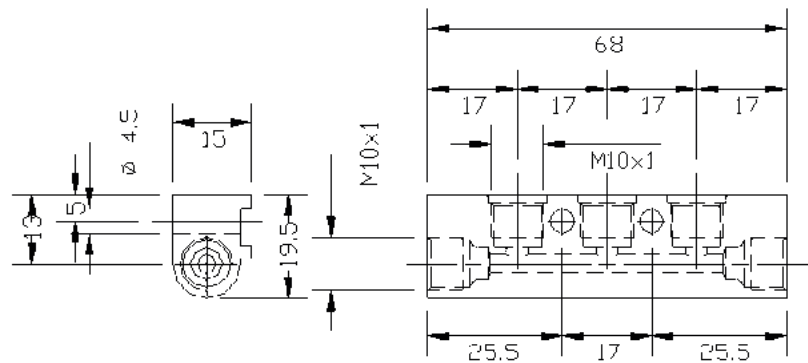

M10x1 - M10x1 5 Vie



Codice 01.961.2

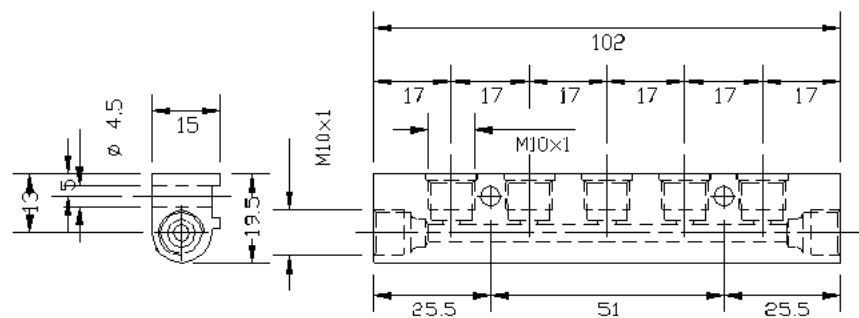

Valvole dosatrici a pistone singole

Le valvole singole possono essere usate per sostituire valvole difettose montate sulle uscite dei distributori con filettatura M8x1.

M8x1 - M8X1

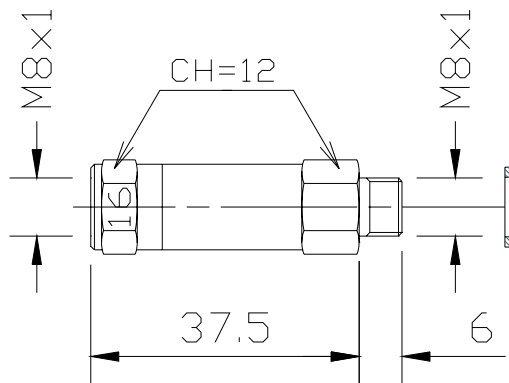
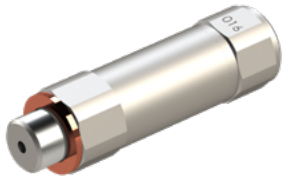

Codice	Portata	Mark
02.610.1	30 mm ³	3
02.610.2	60 mm ³	6
02.610.3	100 mm ³	10
02.610.4	160 mm ³	16

M8x1 - M10X1

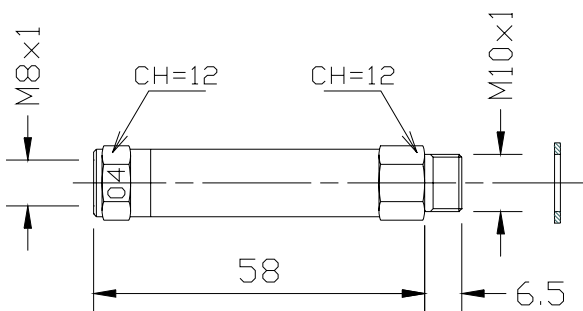

Codice	Portata	Mark
02.611.5	30 mm ³	3
02.611.6	60 mm ³	6
02.611.7	100 mm ³	10
02.611.8	160 mm ³	16

M10x1 (M) - M10x1 (M)

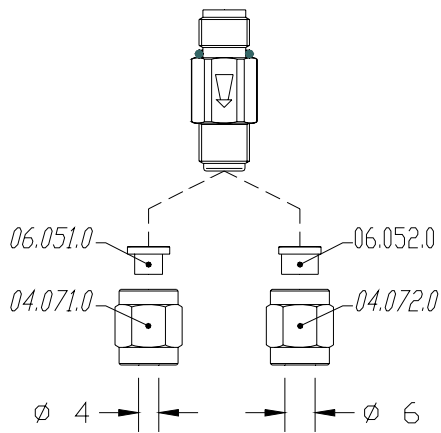

M10x1 (M) - M8x1 (F)

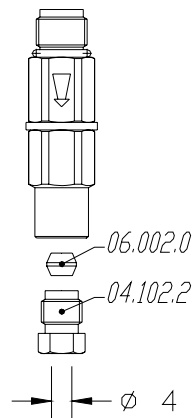

M10x1 (M) - PUSH-IN

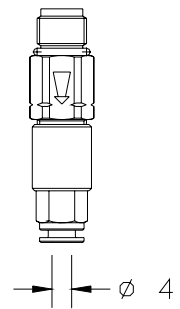

1/8" (M) - M10x1 (M)

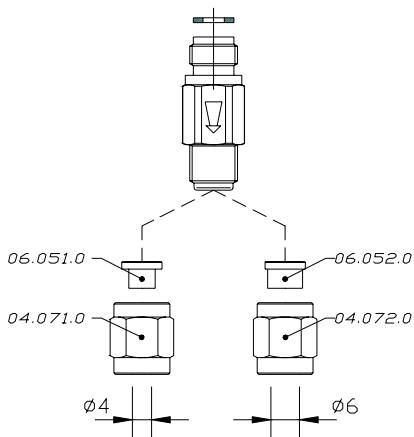

1/8" (M) - 5/16" (F)

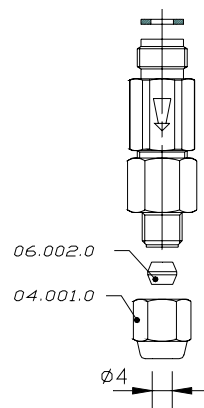

1/8" - PUSH IN

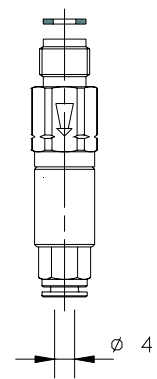

M10x1 (M) - 1/8" (M)

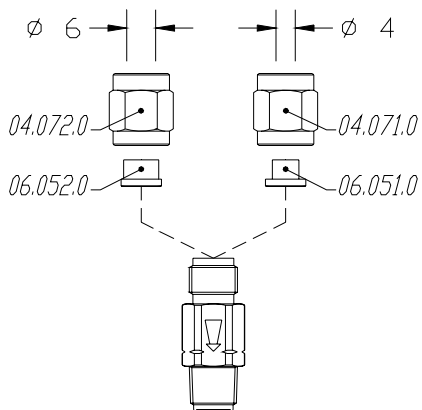

Raccordi per Distributore M12x1 - M10x1

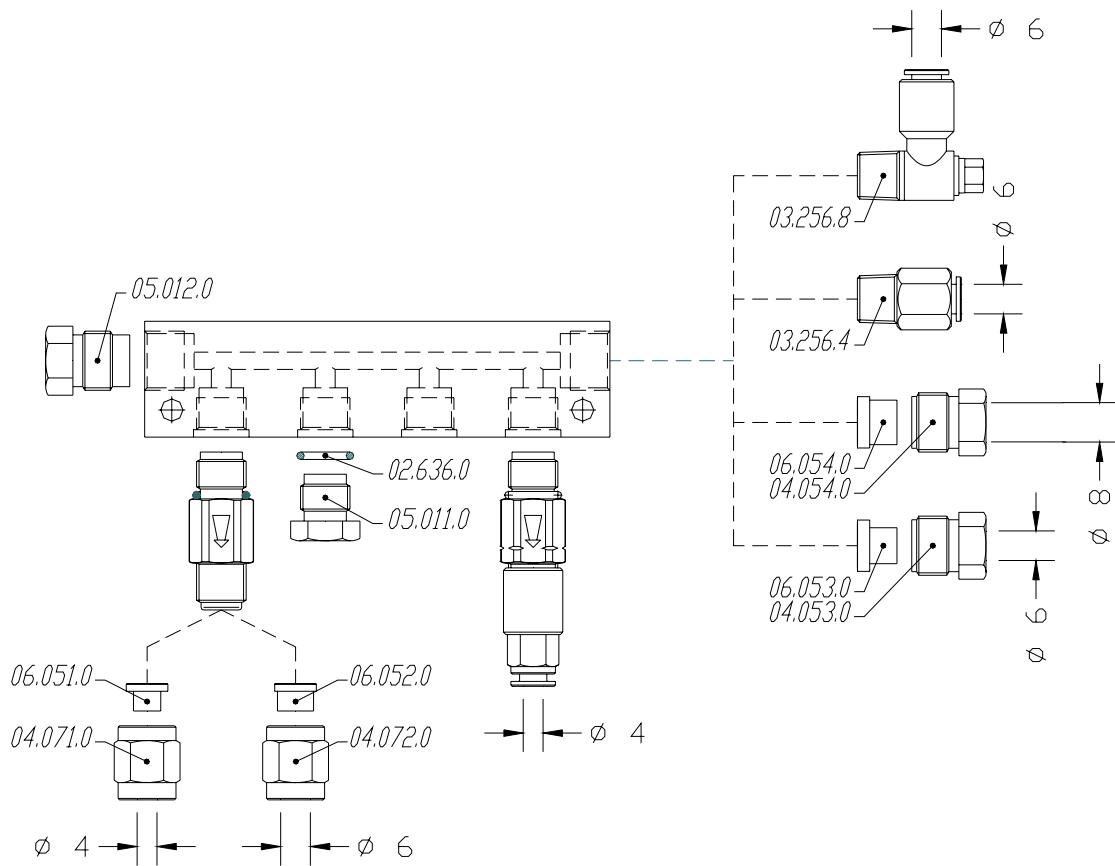

Raccordi per Distributore M10x1 - M10x1

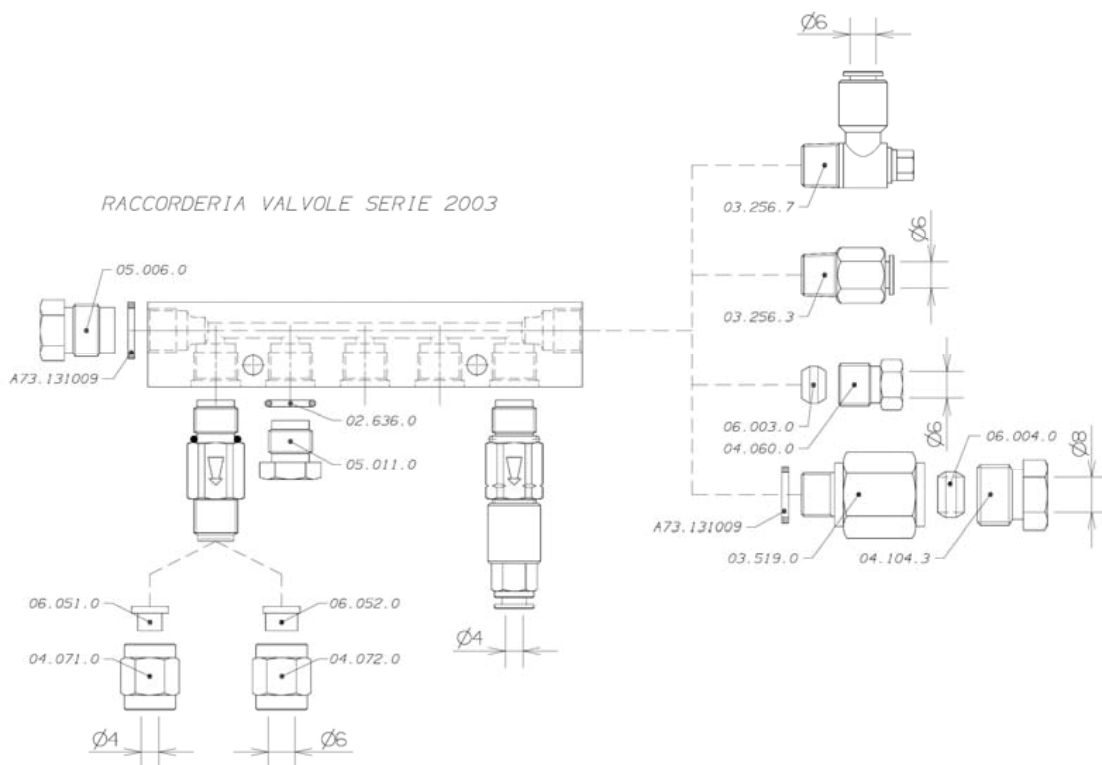

Raccordi per Distributore 1/8" - 1/8"

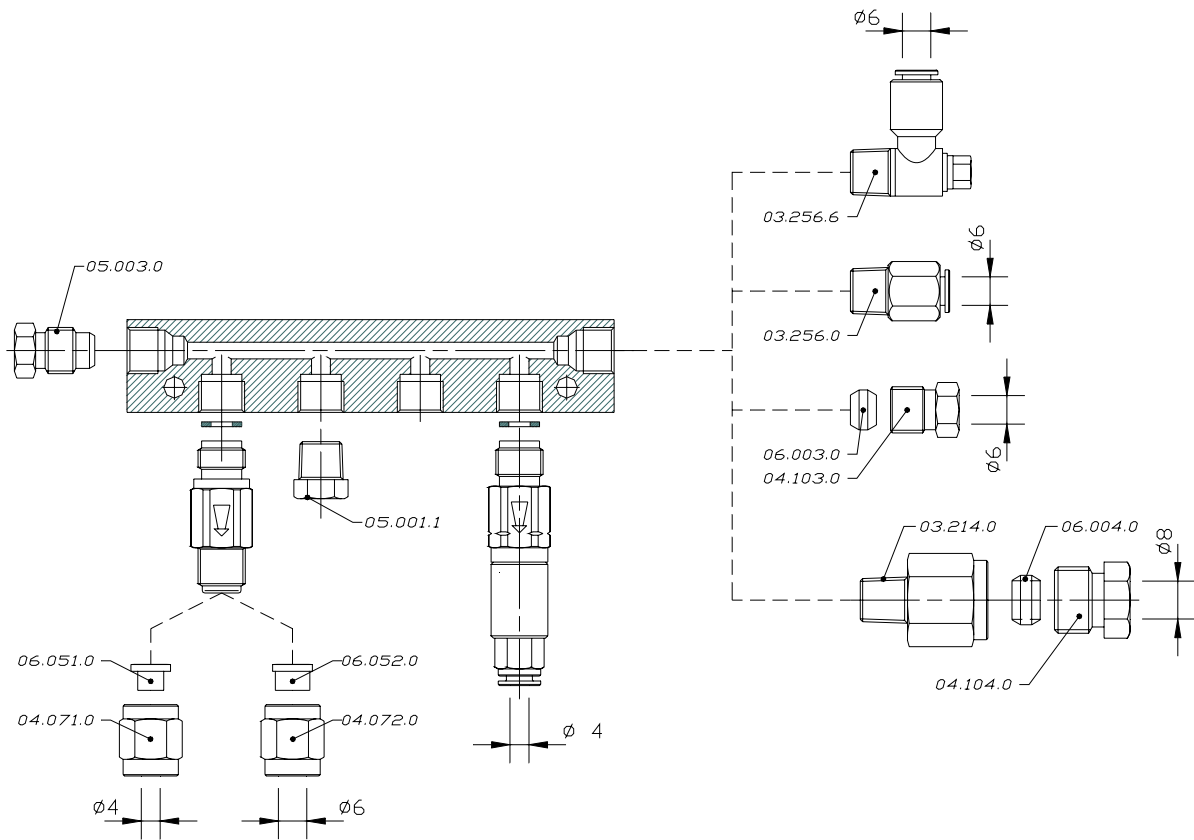

Raccordi per Distributore 2 vie M12x1 - 6 vie M10x1

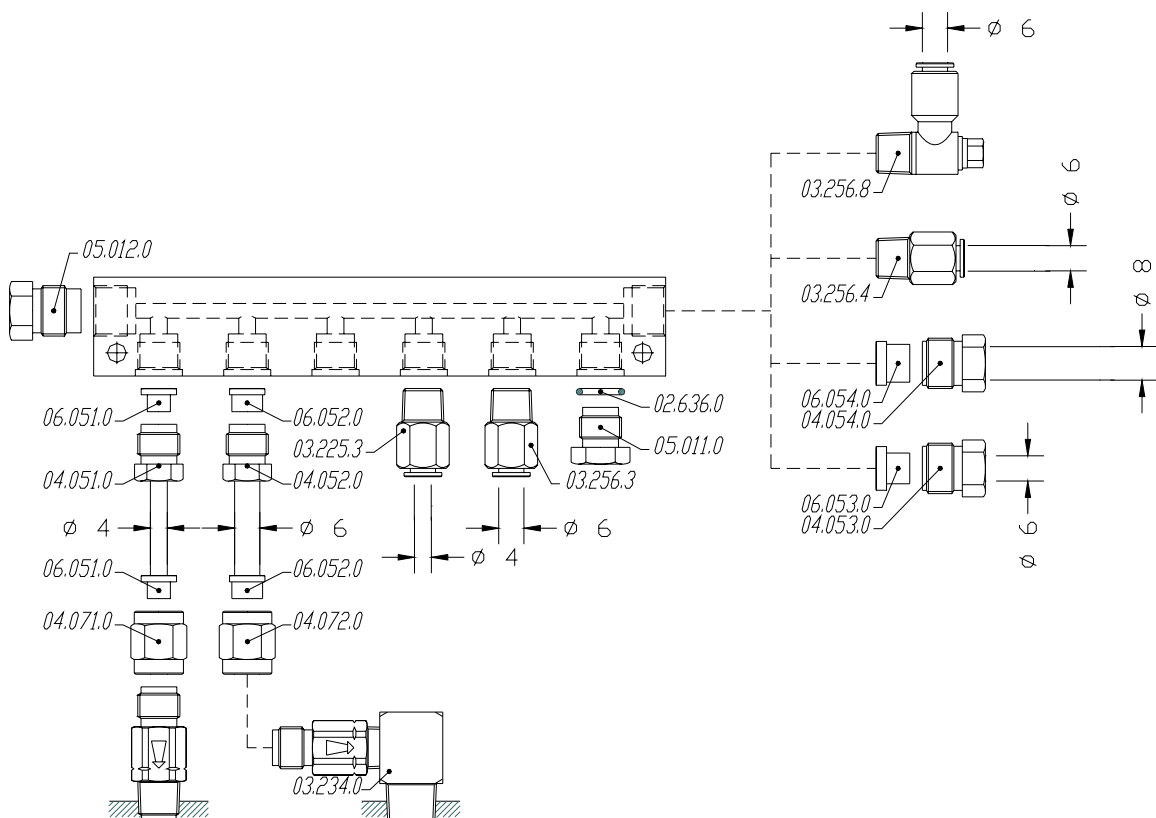

Raccordi per terminali girevoli

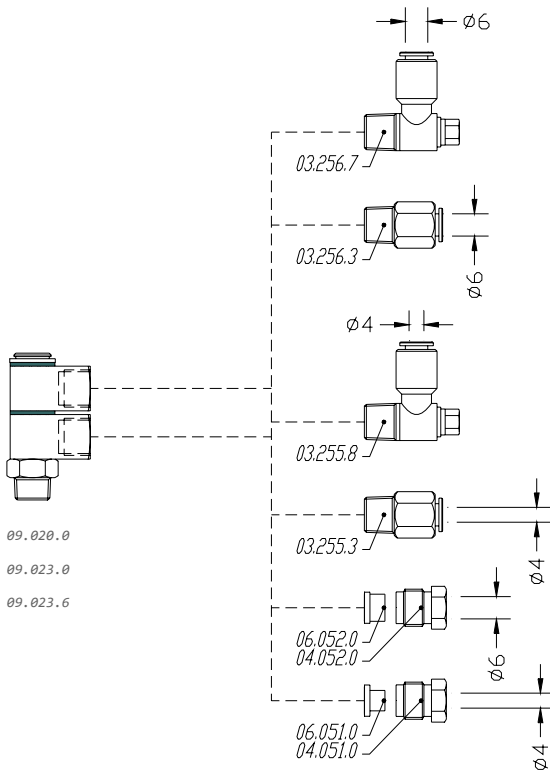
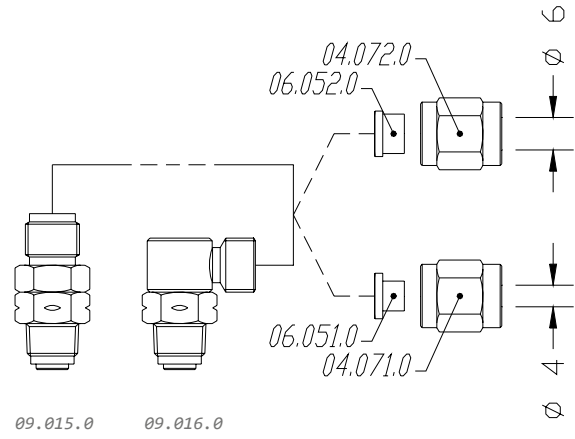
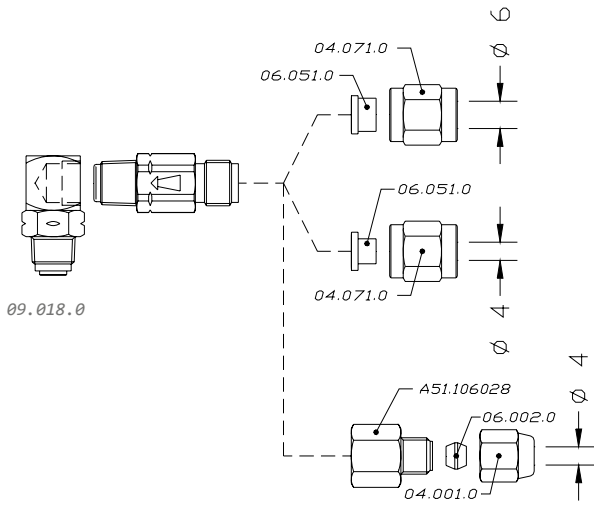

I.L.C. srl - Via Garibaldi, 149 - 20155 Gorla Minore - Italy
Phone +39 0331 601697 - Fax +39 0331 602001 - www.ilclube.com - info@ilclube.it

