

lubrication systems



CME

Electric pump for oil and
soft grease volumetric
lubrication systems



TABLE OF CONTENTS

Table of contents	2
Description and technical data	3
Operation and technical data	4
Technical data (motor, sensors)	5
Command and control	6
Internal timer	7
Order code configurator	8
Overall dimensions (2L)	9
Overall dimensions (3L)	10



All ILC products should only be used for the intended purposes, as specified in this brochure and in all instructions. If the product is supplied with the operating instructions, the user is required to read and follow these instructions. Not all lubricants are suitable for central lubrication systems. The ILC lubrication systems or their components can not be used in combination with gases, liquid gases, pressurized gas in solution and liquids whose vapor pressure exceeds normal atmospheric pressure (1013 mbar) by more than 0.5 bar, maximum permissible temperature. Hazardous materials of any kind, especially those classified as such by the European Community Directive EC 67/548 / EEC, Article 2 (2), may be used in centralized lubrication systems of the ILC or their components and provided and / or marketed with them only after consultation with the ILC and after receiving written permission from the company.

Description

CME electric pumps have been developed for single line lubrication systems fitted with volumetric metering valves or air-oil mixers.

The unit consists of a gear pump, an electric motor, a low level switch, an electronic control card (upon request), a green LED (indicates power ON), a yellow LED (indicates pump working), a pressure gauge, a push button for intermediate lubrication and a pressure switch. Alternatively, the pressure switch can also be put at the end of the main line.

The plastic cover protects the electrical components from environmental conditions like dirt or dust. The transparent impact-resistant reservoir has a capacity of 2 or 3 litres.

A set of valves which provides the decompression and bypass functions is connected to the gear pump.

The lubricants that can be used are oil with a viscosity range between 50 and 1000 cSt (CME-O) or soft grease with a NLGI consistency of 000-00 (CME-G). The two models have different sensors fitted for level control (see technical data sheet).

example of an air-oil system

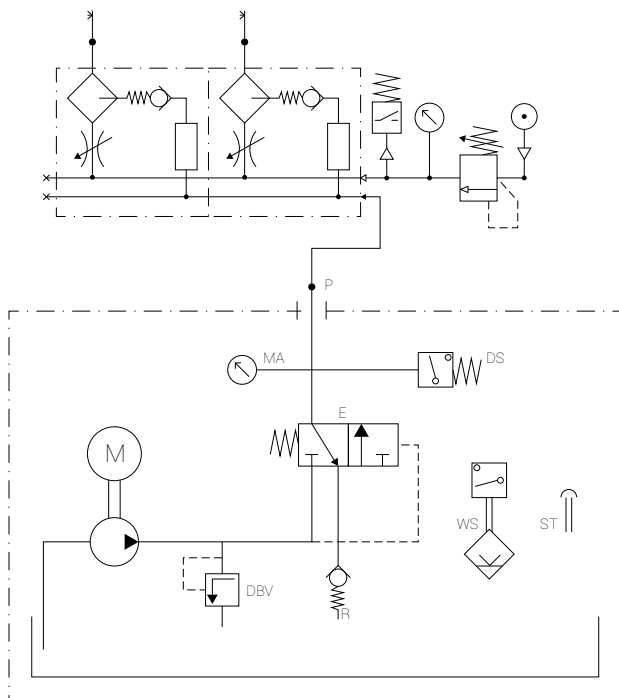

example of a volumetric system

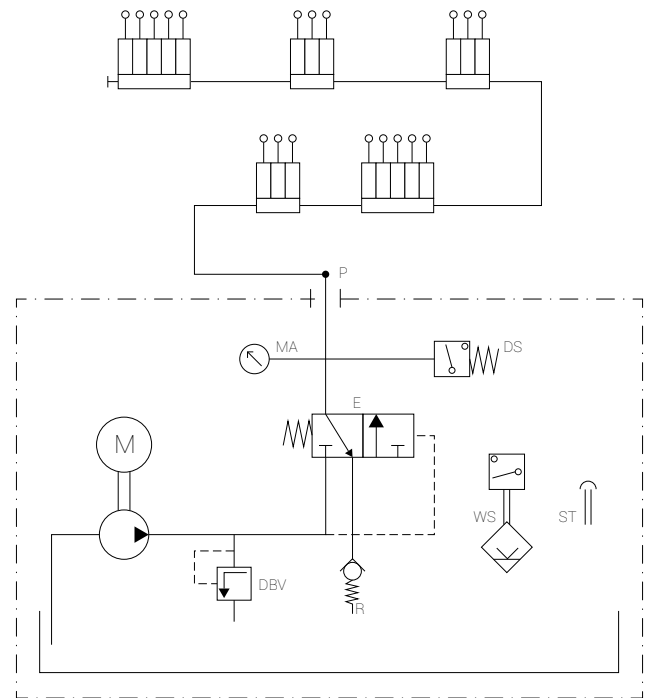

Operation

In order to control the system, it is necessary to alternate a working time (pump running) with a rest time (pump stopped). At the end of the rest time the pump starts and the lubricant pressure rises up to 22-30 Bar and activates the external volumetric valves or those that are integrated in the mixers (air-oil).

The pressure switch, which is activated by the oil pressure, closes the contact and indicates that the pump is working properly. If it is not activated during the working time and the contact stays open, it will send an alarm signal.

The electric level, which is open when the reservoir is empty, monitors the level of lubricant inside the reservoir. The push button can be pressed for intermediate lubricating operations. The green LED lights up to indicate that the pump is on, the yellow LED lights up to indicate that the pump is working. If there is an internal timer, that commands and controls the system, a red LED and a clean contact will indicate any faults.

Technical data

Reservoir capacity	2l - 3l
Capacities measured (A)	100cc/1' 50Hz
	120cc/1' 60Hz
	200cc/1' 24 V DC
Outlet connections	2 BSP 1/4" seats (standard supplied with 1 left-hand lock cap)
Electrical connections	1 cable gland for power supply 1 cable gland for signals
Filling	Cap with 200 µ load filter
Pressure gauge	0 - 60 bar
Operating pressure	24-30 bar
Lubricants	Oils 50 to 1000 cSt Soft greases NLGI 000 and 00
Operating temperature	0°C - 50°C
Protection rating	IP-54
Weight (reservoir empty)	3.5 Kg (2l)
	4.3 Kg (3l)

(A) performances measured with lubricant with 100 viscosity (cST) and 5 bar back pressure.

Motor



AC motor

Rated voltage	115V	230V
Rated power	110 W	
Rated current	1.5 A	0.78 A
Operating mode according to DIN EN 60127 - 2 (B)	S3, 20%	
Rated frequency	50/60 Hz	
Temperature switch	Integrated	

DC motor

Rated voltage	24 V DC
Rated power	60W
Rated current	3 A
Operating mode according to DIN EN 60034 - 1 (B)	S3, 20%
Internal fuse	6.3 A

Pressure switch

Contact	Open in the absence of pressure
Calibration pressure	22 bar
Operating voltage	less than 250 V AC
Maximum switching current	0.5 A

Electric low oil level

Reed contact	closed in the presence of oil
Trip voltage	1.5 A - 250 V AC - 200 V DC - 50 W

Electric low soft grease level

Capacitive sensor	closed in the presence of soft grease
Operating voltages	10 to 36 V DC
Outlet load	< 10 mA (24 V), < 15 mA (36 V)
Protection against short circuit and reverse polarity	Yes

(B) S3 operating mode (intermittent operation) indicates the ratio between the operating period and the shut-down period. 2 minutes cycle time at 20% -> 2minx0.2=0.4min (working time). Therefore a shut-down time of 1.6 minutes. The maximum working time is 6 minutes. The electric motor has a thermal protection that stops it when it reaches 120°C; it can only start again when the temperature drops below 100°C.

Electric pump without internal timer

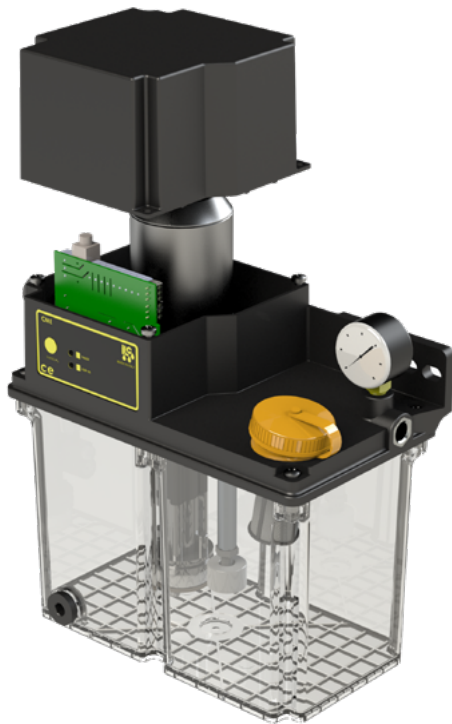

The pump is activated and controlled by the machine's PLC.

It is supplied with a push button for possible intermediate lubricating operations, power LED and pump working LED.

It also has a pressure switch for lubricant pressure control, an electric low level sensor (open when the reservoir is empty) and a pressure gauge.

The power LED (GREEN) and the operating LED (YELLOW) are on the front panel.

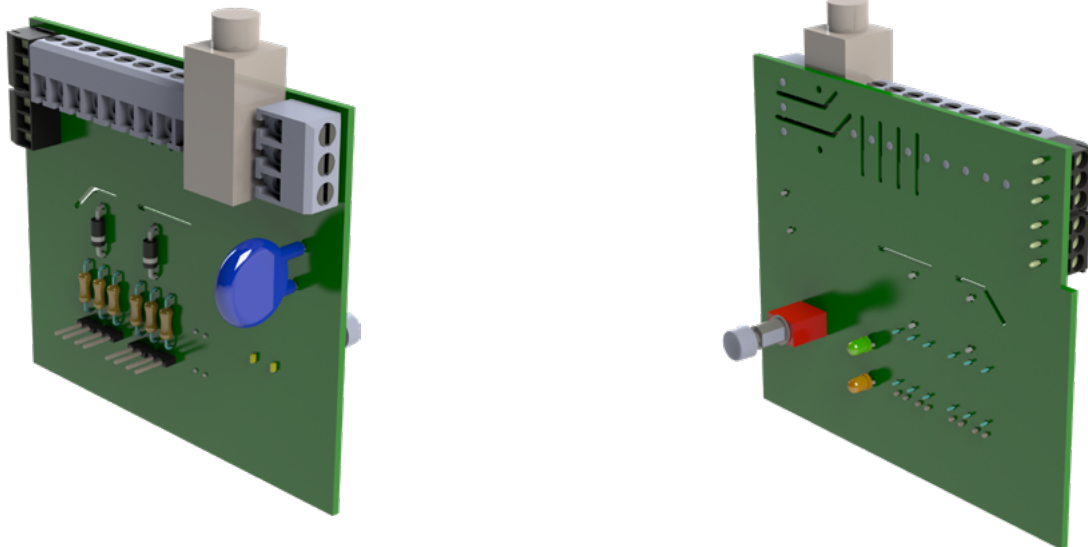

internal electronic card

Electric pump with internal timer



The pump is controlled by an internal timer. All settings can be programmed with the keys on the external front panel, without opening the cover.

The various error and operating messages are displayed above the function keys. The power LED (GREEN), the operating LED (YELLOW) and the alarm LED (RED) are next to the display.

The pump is supplied with a pressure switch for lubricant pressure control, an electric low level sensor (open when the reservoir is empty) and a pressure gauge.

Functions

- Adjustment of the pause time in minutes-hours.
- Adjustment of the pause time according to the external pulses.
- Adjustment of the working time in seconds-minutes
- Circuit pressurisation control.
- Memory: at switch-on the pump starts from the point in which it was stopped.
- Pre-lubrication: at switch-on the pump starts with a lubrication cycle (working).

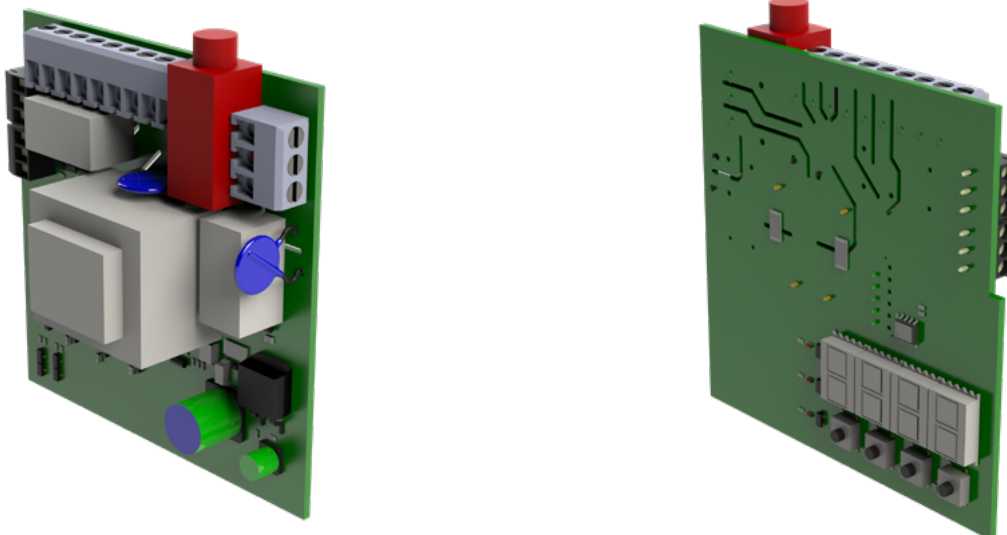

internal electronic card

CME order code configurator



A (Lubricants)		B (Reservoir)		C (Control)		D (Power supply voltage)	
Soft grease	G	2L	2	External control	CE	24 V DC	24V
Oil	O	3L	3	Internal electronics	CT	115 V AC	115
						230 V AC	230

Push-in fittings

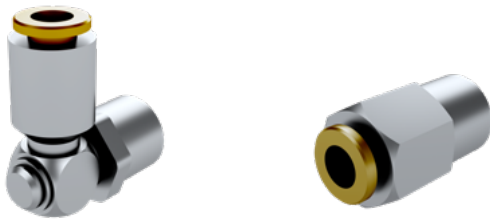

Code	Figure	Pipe	Tapered thread
03.257.4	straight	6	BSP 1/4"
03.257.2	90°	6	BSP 1/4"

Compression fittings

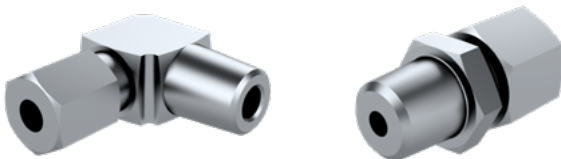

Code	Figure	Pipe	Tapered thread
ZZZ106-005	straight	6	BSP 1/4"
ZZZ106-105-L	90°	6	BSP 1/4"

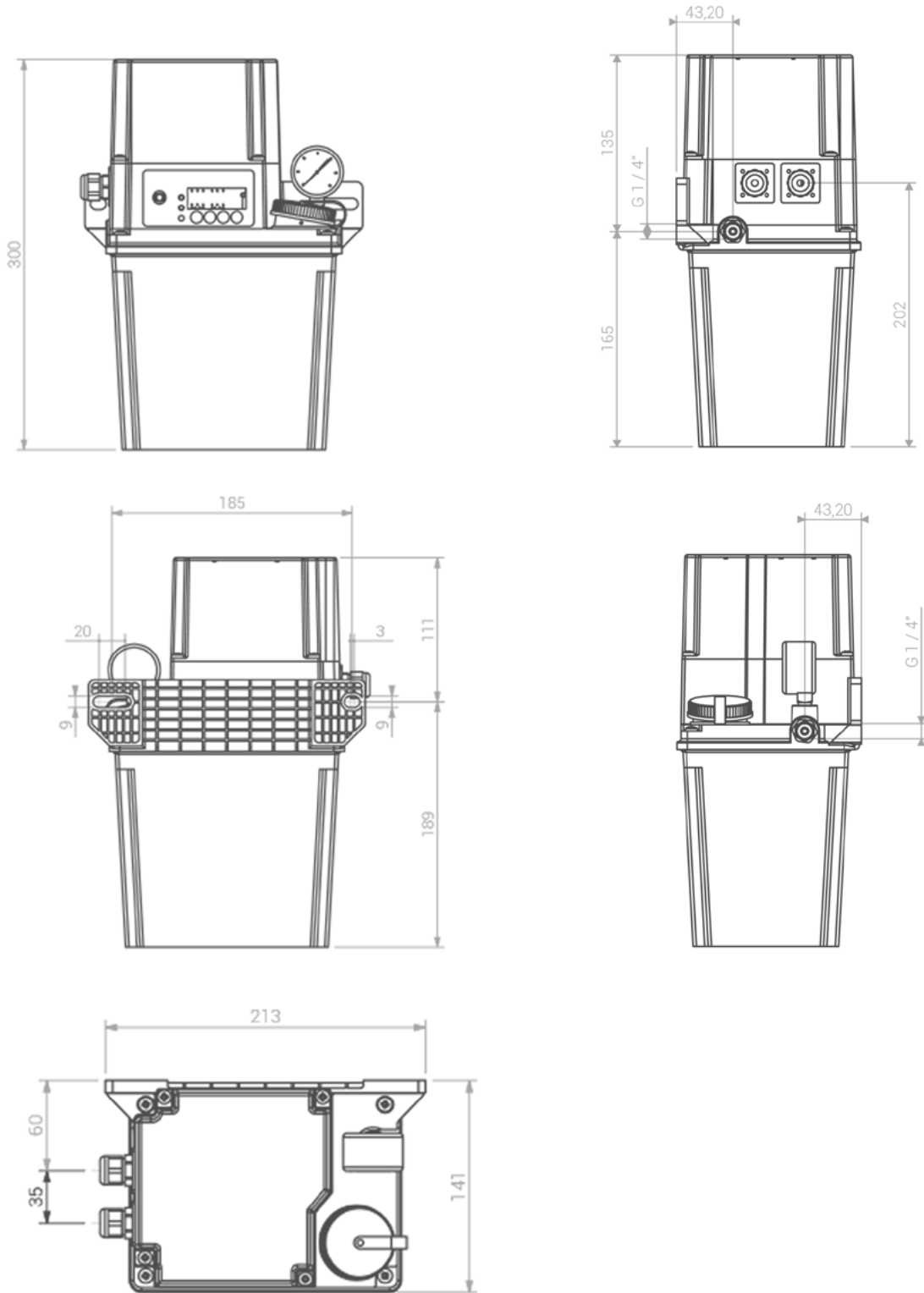

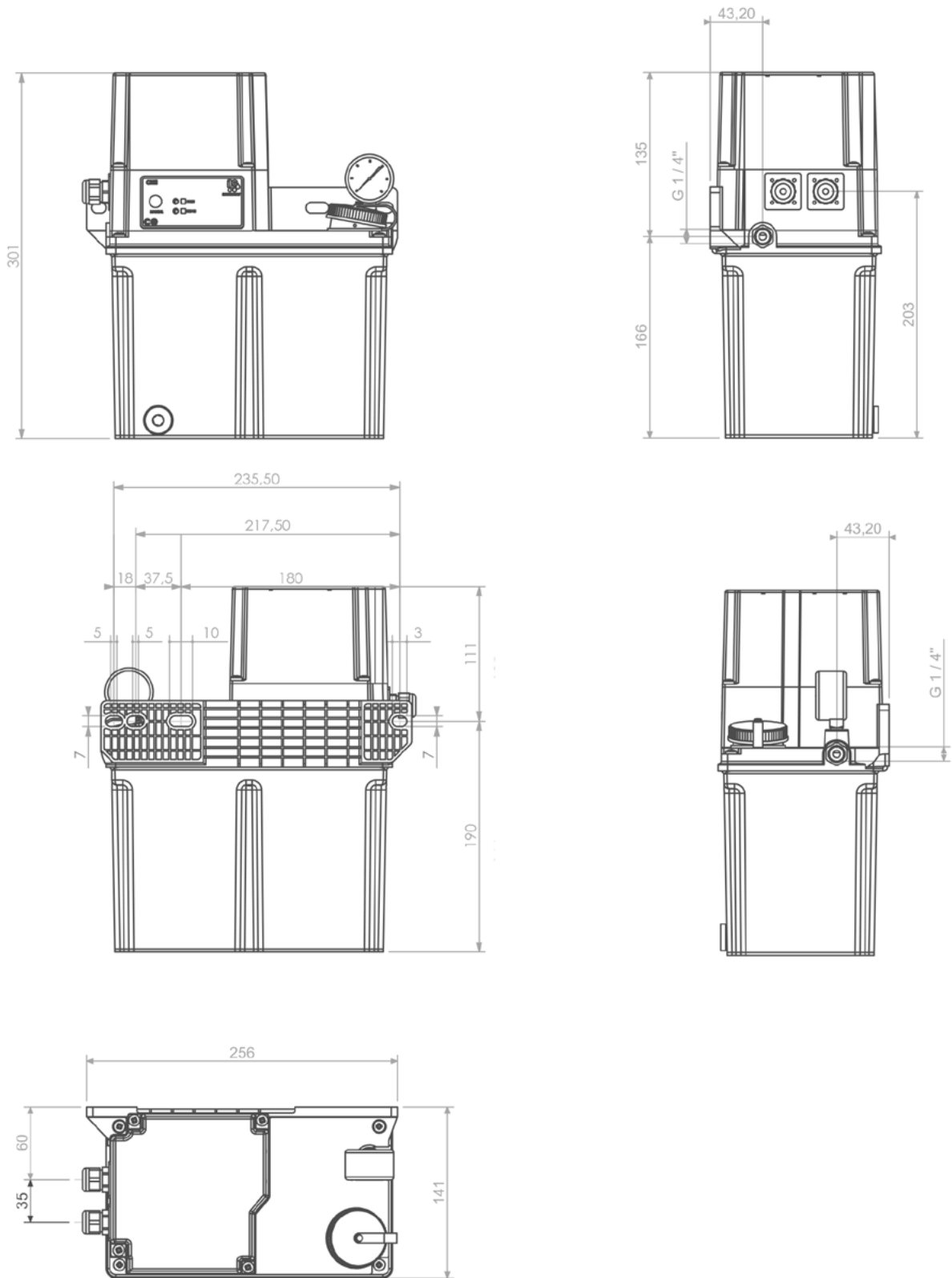

I.L.C. srl - Via Garibaldi, 149 - 20155 Gorla Minore - Italy
Phone +39 0331 601697 - Fax +39 0331 602001 - www.ilclube.com - info@ilclube.it

